

The specifications and/or appearance of the products described in this catalogue are subject to change without previous notice because of necessary modification.



# UNIQUE

PARTS & ACCESSORIES CATALOGUE

# TOPDIS

## 包缝机自动剪线装置[简易侧吸款] Automatic trimmer device for overlock sewing machine[Chain cutter]



### 套装组合说明/PACKAGE INSTRUCTION:

包缝机自动剪线装置 Overlock Auto-trimmer device		功能配置 Functional configuration
组合一 Type one	侧吸刀组+集尘组 Chain cutter+dust collecting assembly	① ② ③ ④ ⑤ ⑥ ⑦ ⑩ 剪线+吸布屑 Thread trimming+cloth dust absorption
	侧吸刀组+集尘组+抬压脚 Chain cutter+dust collecting assembly+foot lifter	① ② ③ ④ ⑤ ⑥ ⑧ ⑨ ⑩ 剪线+吸布屑+抬压脚 Thread trimming+cloth dust absorption+foot lifter
组合二 Type two	侧吸刀组+集尘组+电机电控 Chain cutter+dust collecting assembly+Motor + Control box	① ② ③ ④ ⑤ ⑥ ⑦ ⑩ ⑪ ⑫ 剪线+吸布屑+直驱电机 Thread trimming+cloth dust absorption+DD motor
	侧吸刀集尘组+抬压脚+电机电控 Chain cutter+dust collecting assembly+foot lifter +Motor+Control box	① ② ③ ④ ⑤ ⑥ ⑧ ⑨ ⑩ ⑪ ⑫ 剪线+吸布屑+直驱电机+抬压脚 Chain cutter+link collector +DD motor+foot lifter
组合三 Type three	侧吸刀集尘组+抬压脚+电机电控+光眼感应(三联电磁阀) Chain cutter+dust collecting assembly+foot lifter+Motor +Control box+Sensor	① ② ③ ④ ⑤ ⑥ ⑨ ⑪ ⑫ ⑬ ⑭ ⑮ ⑯ ⑰ 间歇吸气+松线 Intermittent suction+thread releaser

备注: 适用机型同 包缝机自动剪线装置[侧吸款]  
Remarks: Apply to same model of Automatic trimmer device for overlock stitching sewing machine[Chain cutter]

# TOPDIS

## 包缝机自动剪线装置[侧吸款] Automatic trimmer device for overlock stitching sewing machine[Chain cutter]

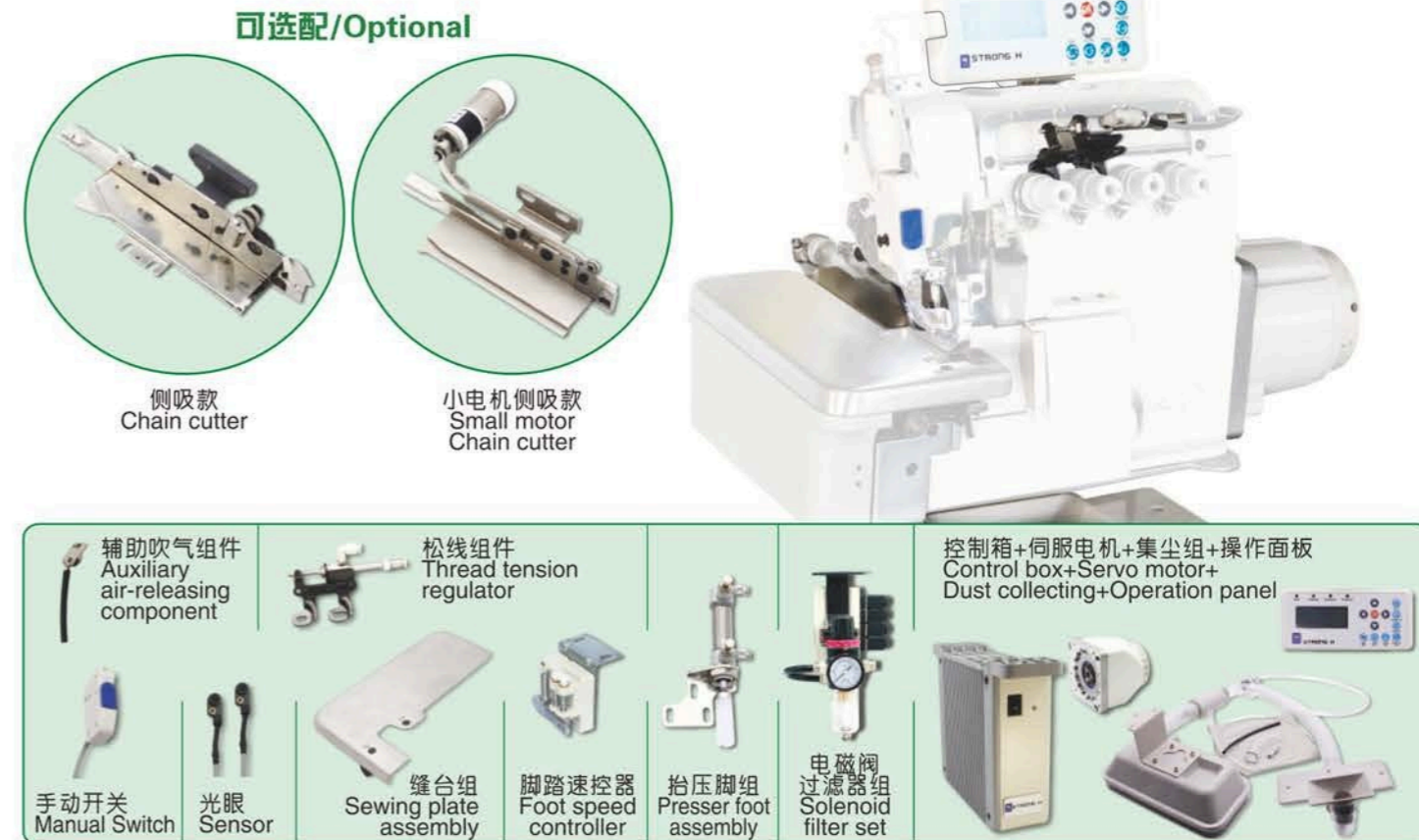

### 产品优势/ADVANTAGES:

- 采用小电机驱动，间歇式切线结构，只在前、后切线时刀片才会动作，与传统刀组相比，刀片寿命提高5倍以上；  
It adopts small motor driven and intermittent thread cutter structure that knife moves only when front back cutting. The lifetime of knife improves more than 5 times compared with common knife.
- 可设定不同的吸气模式，大小可调，需要时开启或关闭，减少噪音，低耗省气，比传统长吸方式节约用气量70%以上；  
The device will reduce noise and save gas, because setting different suction models which is adjustable being turned on or off suction when needed. Save more than 70% of the gas consumption than the traditional long suction method.
- 剪线顺畅无停顿；  
Thread trimming smoothly without pausing;
- 可调式吹气结构，使线头更容易进入刀口，切线稳定快捷，提升加工效率40%左右，约3-4个月收回成本。  
The thread can enter auto the blade easily and could be cut stably and conveniently because of adjustable blowing structure. It improves the efficiency around 40%. It will recover the cost within 3~4 months.

### 适用范围/SCOPE OF APPLICATION:

- 针织、梭织所有拼缝驳片工艺，上衣：拉肩膊、上袖、埋夹、袋布、上袖口、下摆罗纹；裤子：侧骨、前后浪、底浪、脚口橡筋、内裤等。  
Knitting and woven floss seaming, such as shoulder pull, sleeve, feed off the arm, pocket fabric, cuff, bottom rib, trousers: side seam, front and back rise, bottom rubber band, under wear etc.

内容/名称 Content	型号/规格 Model
飞马 PEGASUS	M800/M900/MX5200/EX5200
大和 YAMATO	CZ6000/AZ8000
重机 JUKI	MO-6700/MO-6800/MO-6900
银箭 SIRUBA	700K/988
宝狮 KINGTEX	UH9000

### 切线布样/SAMPLE



剪线后线头长度可控制在3-5mm以内  
the needle thread can be controlled within 3-5mm

# TOPDIS

## 包缝机自动剪线装置[斩刀款] Automatic thread trimmer device for overlock sewing machine[Chopper type]

### 可选配/Optional



斩刀气动款  
Chop Pneumatic

斩刀电动款  
Chop Electric

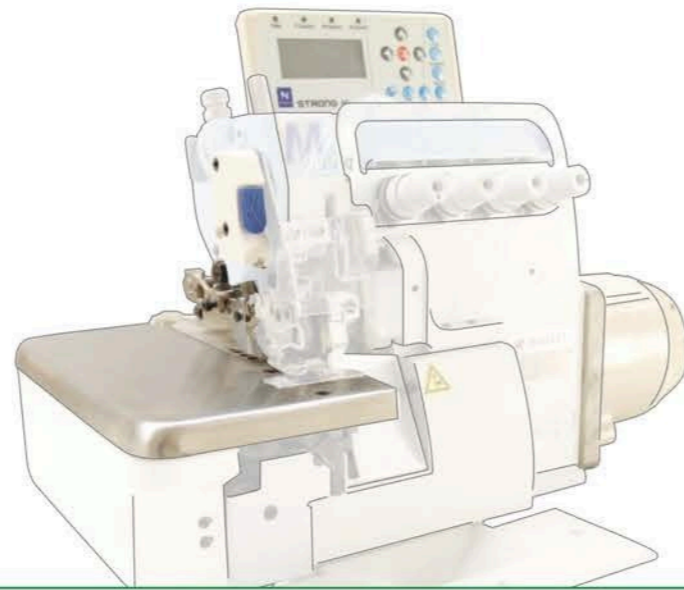

伺服电机+控制箱+集尘组+操作面板  
Servo motor+Control box+  
Dust collecting+Operation panel

### 产品优势/ADVANTAGES:

- 三光眼，防止误斩误切，配备空踩锁机功能，杜绝线的浪费，每天可省1个线圈以上；  
The device eliminates the waste of thread that it can save more than 1 coil per day, is equipped with three sensors that could be chopped correctly, and with locking function when stepping;
- 采用直驱式软连接结构电机，省电40%左右，每年每台机器节约电费上千元，转速高达7000RPM、噪音低。  
The rotating speed can be up to 7000RPM with low noise and save about 40% electricity because of direct drive motor adopted.
- 间歇吸气，比传统长吸方式节约用气量80%以上；  
Compared to traditional continual suction type, it can save more than 80% gas consumption for the reason that adopted with intermittent suction;
- 可提升加工效率35%左右，约3~5个月收回成本；  
It improves the efficiency around 35% and will recover the cost within 3-5months;

### 适用范围/SCOPE OF APPLICATION:

- 针织、梭织所有拼缝驳片工艺，上衣：拉肩膊、上袖、埋夹、袋布、上袖口、下摆罗纹；裤子：侧骨、前后浪、底浪、脚口橡筋、内裤等。  
Knitting and woven float seaming, such as shoulder pull, sleeve, feed off the arm, pocket fabric, cuff, bottom rib, trousers: side seam, front and back rise, bottom rubber band, under wear etc.

内容/名称 Content	型号/规格 Model
飞马 PEGASUS	M800\M900\MX5200\EX5200
大和 YAMATO	CZ6000/AZ8000
重机 JUKI	MO-6700/MO-6800/MO-6900
银箭 SIRUBA	700K/988
宝狮 KINGTEX	UH9000

### 切线布样 / SAMPLE



剪线后线头长度可控制在3-5mm以内  
the needle thread can be controlled within 3-5mm

# TOPDIS

## 包缝机自动剪线装置[一体机] Automatic thread trimmer device for overlock sewing machine [Built-in Type]

### 可选配/Optional 侧吸款/Chain cutter



小电机侧吸款  
Small motor Chain cutter



### 可选配/Optional 斩刀气动款/Chop Pneumatic

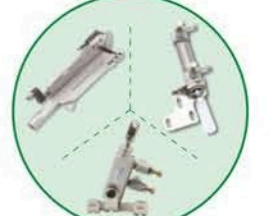

斩刀电动款/Chop Electric

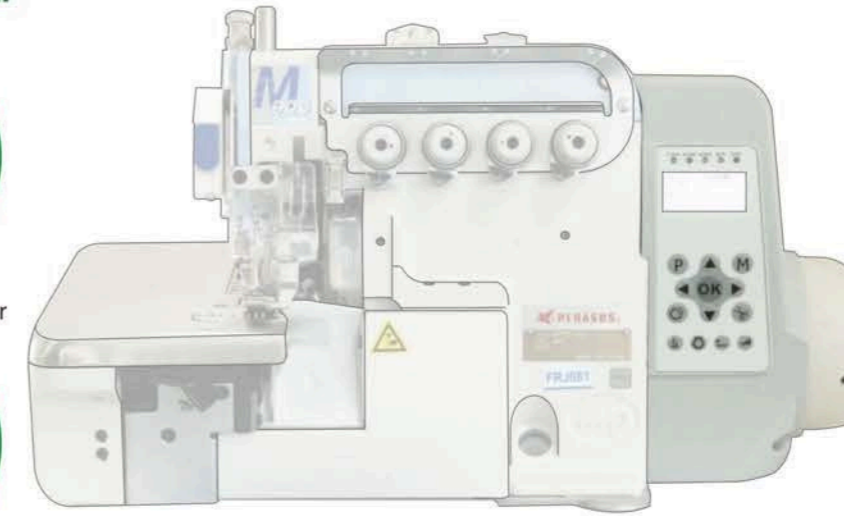

### 产品优势/ADVANTAGES:

- 电动、气动自动识别，维修方便，比常规包缝机安装更省时；  
Compared to common overlock sewing machine, it is convenient for maintenance and installation because of the automatically electric or pneumatic recognition;
- 无需更换原机针板、牙齿、压脚，稳定性高；  
The device is highly stable that it keeps the original machine needle plate, feet dog, presser foot;
- 光眼自动识别，剪线顺畅省时，转速高达7000RPM，提升效率40%以上，约5-6个月收回成本。  
Automatic recognition of sensor, smoothly and time-saving thread cutting, rotating speed up to 7000RPM. It improves the efficiency around 40%. It will recover the cost within 5~6months.
- 外形美观，线头长度3-5mm。  
Nice appearance and the length of thread end is 3-5mm.

### 适用范围/SCOPE OF APPLICATION:

- 针织、梭织所有拼缝驳片工艺，上衣：拉肩膊、上袖、埋夹、袋布、上袖口、下摆罗纹；裤子：侧骨、前后浪、底浪、脚口橡筋、内裤等。  
Knitting and woven float seaming, such as shoulder pull, sleeve, feed off the arm, pocket fabric, cuff, bottom rib, trousers: side seam, front and back rise, bottom rubber band, under wear etc.

内容/名称 Content	型号/规格 Model
飞马 PEGASUS	M800\M900\MX5200\EX5200
大和 YAMATO	CZ6000/AZ8000
重机 JUKI	MO-6700/MO-6800/MO-6900
银箭 SIRUBA	700K/988
宝狮 KINGTEX	UH9000

### 切线布样 / SAMPLE



剪线后线头长度可控制在3-5mm以内  
the needle thread can be controlled within 3-5mm

# TOPDIS

## 包缝机自动切带装置 Auto tape cutter device for overlock machine

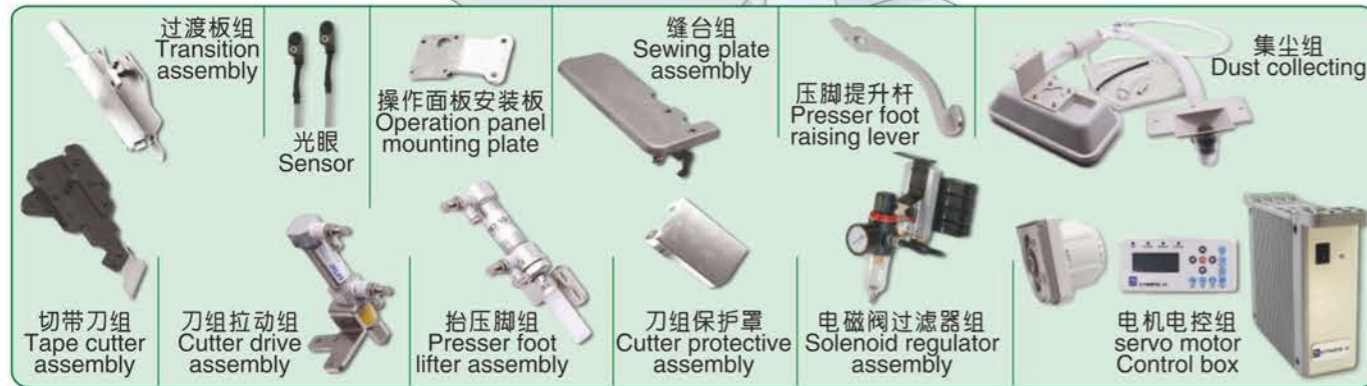

### 产品优势/ADVANTAGES:

- 无需更换原机针板、牙齿、压脚，安装快捷且稳定性高；  
No need change original needle plate, feet dog and presser foot, easy installation, more stable;
- 采用直驱式软连接结构伺服电机，省电40%左右、转速高达7000RPM、噪音低；  
Use direct soft connect structure servo motor, save power 40%, rotating speed up to 7000RPM, low noise
- 切带顺畅无需停顿，长度可控制在5mm左右。效率提升40%左右，约3~4个月收回成本。  
Belt cutting smoothly, improve the efficiency around 40%, recover the cost within 3-4 months.

### 适用范围/SCOPE OF APPLICATION:

- 上衣、裤子驳片、拉脚边、落内胆脚边巾，针织款式落肩带及拼缝等工艺。  
Coat, pants bar, side tape, drop strap and patchwork and knitting shoulder tape and patchwork etc.

内容/名称 Content	型号/规格 Model
大和 YAMATO	AZ8020/CZ6125(3&4thread)
切带模式种类 cutting mode	前切、后切、前后切、手动切、后踏切 front cutting, back cutting, front and back cutting, manual cutting, back type pedal cutting
切带感应长度 cutting length of induction	1-99针 1-99Needle
切带宽度 cutting width	≤ 30mm
切带厚度 cutting thickness	≤ 2.5mm
最窄布片宽度 minimum fabric width	45mm
最短布片长度 minimum fabric length	60mm



### 切带布样/SAMPLE



剪线后线头长度可控制在5mm以内  
the needle thread can be controlled within 5mm

# TOPDIS

## 绷缝机自动剪线装置[气动款] Auto trimmer device for interlock sewing machine[Pneumatic Type]



### 产品优势/ADVANTAGES:

- 噪音低，振动小，性能稳定，安全可靠；  
It performs stably with low noise, low vibration;
- 动刀刀头小型化设计，远离压脚，加工厚料时过骨剪线无碰撞；  
During sewing heavy material, the movable knife of UT moves smoothly because of its reasonable and miniature design;
- 运动行程大，剪线速度可调，缝制更平稳；  
Long working distance, adjustable trimming speed, more stable sewing;
- 直驱电机转速高达5000RPM，效率提升40%以上，约5-6个月收回成本。  
Use direct drive motor, improve efficiency more than 40%, rotating speed up to 6500RPM, It will recover the cost within 5-6 months.

### 适用范围/SCOPE OF APPLICATION:

- 针织款厚料、薄料坎单双针工艺：卫衣、套装款式袖夹圈、领口螺纹、脚螺纹，裤头橡筋单针、双针、中分等。  
Single or double needle stitching knitting heavy or light fabric, such as sweater, suit sleeve clip, collar rib, bottom rib, single or double needles or middle stitching elastic waistband of shorts.

气动款 PNEUMATIC	下剪线组 UT	上剪线组 ST	上拨线组 WP	松线组 TT	下剪线驱动组 DD	抬压脚组 LFE	吹线组 TW
UT/WP	●		●	●	●	●	
UT/ST	●	●		●	●	●	
UT/WP/ST	●	●	●	●	●	●	
UT/TW	●			●	●	●	●

备注：适用机型同 绷缝机自动剪线装置[步进款]  
Remarks: Apply to same model of NCTYPE.

### 切线布样/SAMPLE



# TOPDIS

## 绷缝机自动剪线装置[步进款]

Auto trimmer device for interlock sewing machine [NC TYPE]

**低耗/高效/耐用**  
Low consumption  
High efficiency  
Durable

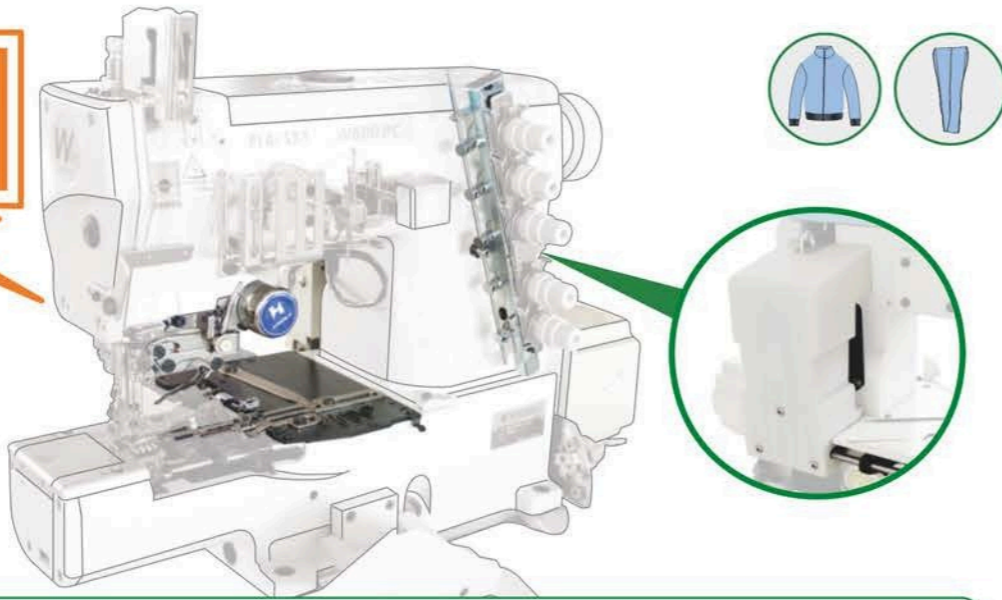

### 产品优势/ADVANTAGES:

- 一体化设计，结构简单，安装便捷；  
Integrative design, simple structure, and easy installation;
- 环保、噪音低，机体震动小，延长机器使用寿命；  
Environmental protection, low noise and less vibration, service life of the machine is extended.
- 使用控制面板调整出刀，割线位置更方便，准确。提升效率40%以上，约5-6个月收回成本。  
The secant line position is more convenient and accurate because of using control panel to adjust the position of the cutter. Working efficiency is improved around 40%. It recovers the cost within 5-6 months.

### 适用范围/SCOPE OF APPLICATION:

- 针织款式所有绷缝工艺：驳片、肩骨袖夹圈、袖口、脚边、领口、前浪、后浪，侧幅等。  
All knitting interlock processes, such as bar, shoulder sleeve armhole, cuff, bottom, neckline, front rise, back rise and side seam etc.



### 与市场传统销售品性能对比/ Performance comparison with conventional device in the market

对比 Compare	市场传统品 Conventional device		步进款 Nctype
	电动款 Electric	气动款 Pneumatic	
噪音 Noise(decibel)	80-85分贝decibel	75-80分贝decibel	75-80分贝decibel
剪线力(kgf) Trimming force	8	9.8-29	17
能源消耗 Energy consumption	1.2	1.35	1.0
使用寿命 Working life	2年左右 about 2 years	5年以上 more than 5 years	8年以上 more than 8 years

### 绷缝机自动剪线装置机型对照表/ Model form for interlock

品牌 Brand	型号 Model	品牌 Brand	型号 Model
飞马 PEGASUS	W264/W562/W562PV	大和 YAMATO	VC2700/VG2700
	W662/W664/W662PV		VE2713
	W1500/W1600		VF2500
银箭 SIRUBA	W3500/W3600	宝狮 KINGTEX	CT6500/FT7000
	C007J/F007J		CT9000/CT9713
	C858K/F858K	星锐 SHING RAY	FW787/FW720
星菱 SHING LING	S007K	重机 JUKI	MF7923/MF7723
	VG888A		MF7500
	VG888S		

# TOPDIS

## 绷缝机自动剪线装置[电动款]

Auto trimmer device for interlock sewing machine[Electric Type]

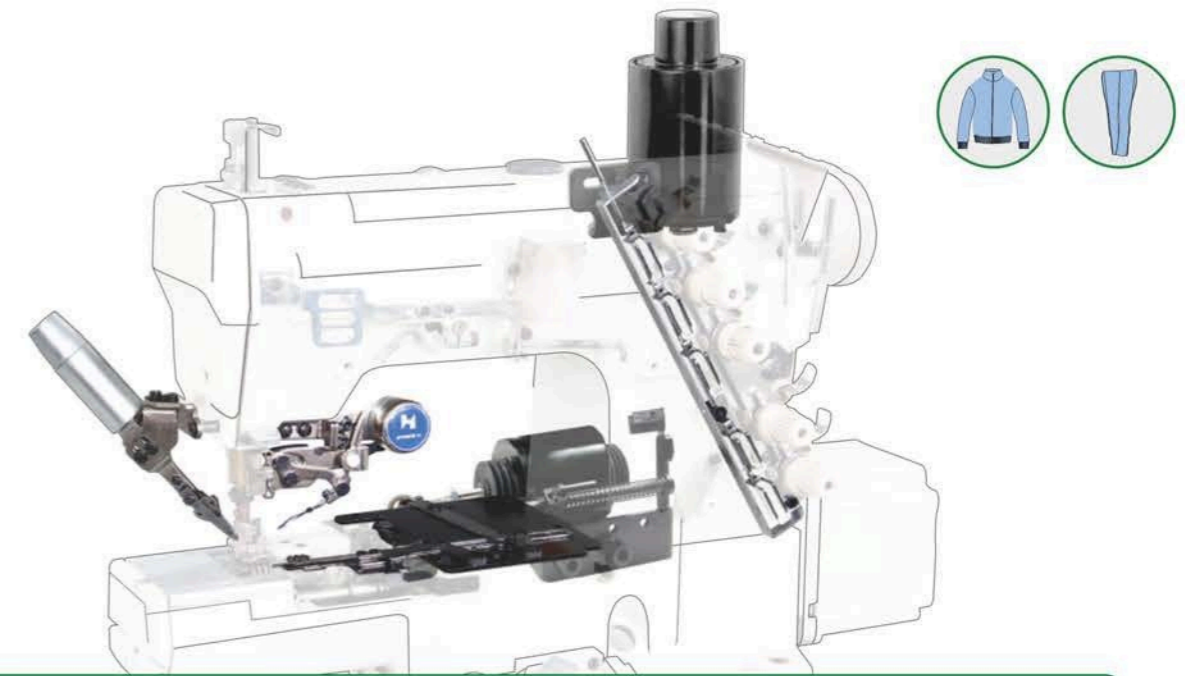

### 产品优势/ADVANTAGES:

- 电磁铁力矩大，夹线稳定，调试简单；  
It's adiveted easily with tight thread clamping and strong electromagnet working;
- 动刀刀头小型化设计，远离压脚，加工厚料时过骨剪线无碰撞；  
During sewing heavy material, the movable knife of UT moves smoothly because of its reasonable and miniature design;
- 直驱电机转速高达5000RPM，安全可靠；  
The direct motor's maximum speed is 5000rpm, safe and stable;
- 小型勾线刀回勾力强，稳定，效率提升40%以上，约5-6个月收回成本。  
Small cutter has strong hooking lined power and is stable.The working efficiency is improved 40%.It will recover the cost within 5-6 months.

### 适用范围/SCOPE OF APPLICATION:

- 针织款式所有厚料、薄料驳片坎单针双针工序：圆领衫、卫衣、袖口罗纹、衫脚罗纹、袖夹圈，裤子前后浪、侧幅、脚口罗纹坎单针、双针、中分；内裤、打底裤坎裤头双针等。  
All single or double needle stitching heavy and fabric light, such as round collar shirt, sweater, vib-knit sleeve opening and shirt bottom, sleeve clip, front and back rise of pants, side seam, single or double needles or middle stitching bottom rib, wasit band of under wear, and leggings double-needle.

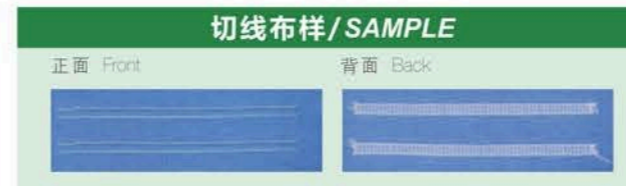

电动款 ELECTRIC	下剪线组 UT	上剪线组 ST	上拨线组 WP	松线器组 TT	下剪线驱动组 DD	抬压脚组 LFE
UT/WP	●		●	●	●	●
UT/ST	●	●		●	●	●
UT/WP/ST	●	●	●	●	●	●

备注：适用机型同 绷缝机自动剪线装置[步进款]  
Remarks: Apply to same model of NCTYPE.

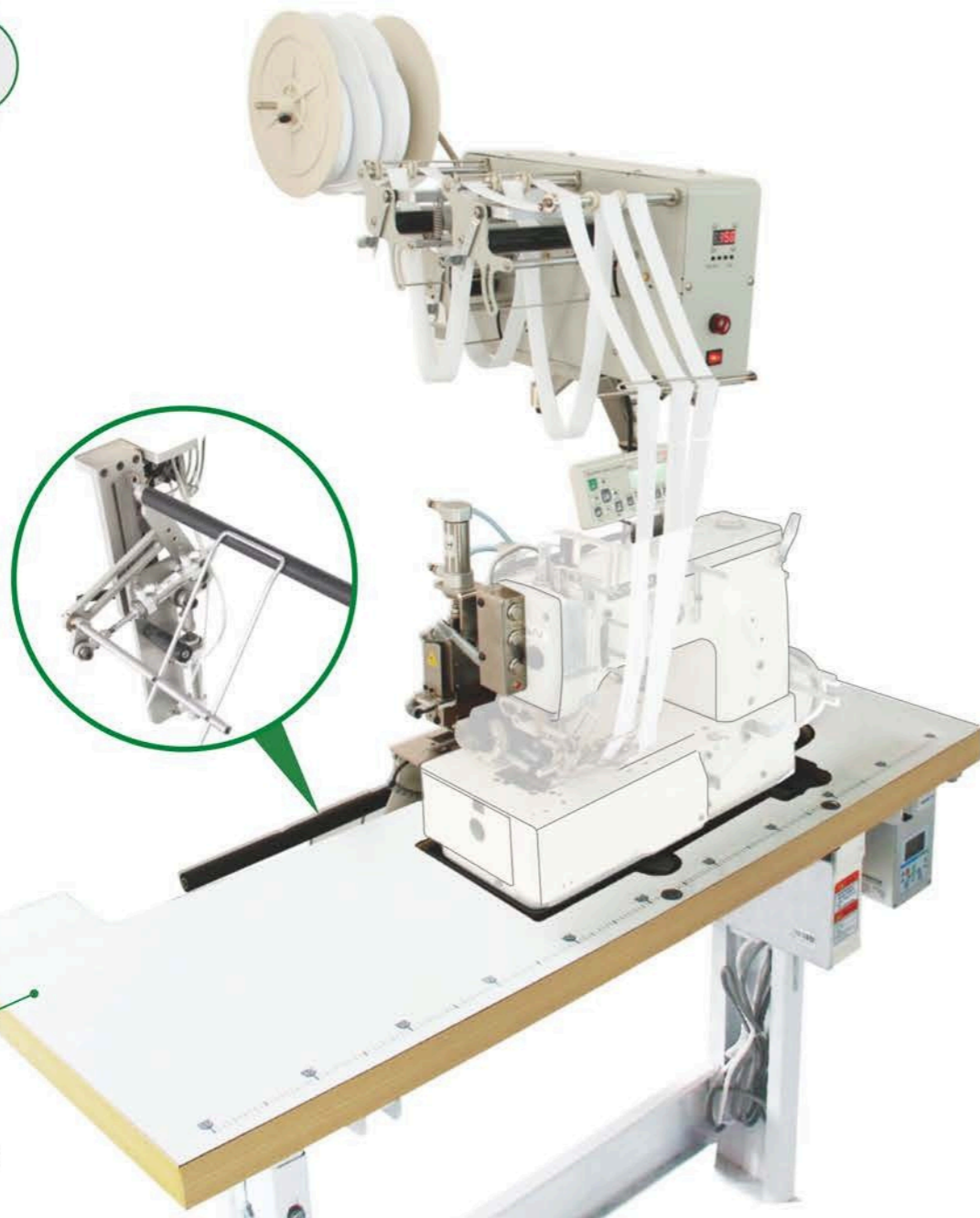

台板机架  
Hand switch  
assembly



### 产品优势/ADVANTAGES:

- 光眼感应布料，通过设置针数控制切带及收料，反应快速准确，效率提升20%左右，约5~7个月收回成本；  
Induct cloth throughly sensors, set stitches to control cutting and receiving belt automatically, the reaction is fast and accurate, improve the efficiency around 20%, recover the cost within 5-7 months;
- 独立驱动送带，输送平、稳、顺，解决三条送带长度不一的状况，捆条利用率最大化；  
Independent belt conveying is smooth, stable and smooth, solve the problem of different length of 3belts, maximize the utilization of belts;
- 使用辅助小拖轮（限于大平台机器），提高切带准确度，避免面料卷拖轮现象；  
Increase the auxiliary small puller( limited to large platforms machines), improve the accuracy of the cutting belt and avoid the phenomenon of fabric roll puller;
- 直驱伺服电机，性能稳定，单脚控制，上下可停针，设计合理，操作方便，省时省力。  
Driven by servo direct drive motor, stable performance, single foot control, up and down can stop the needle, reasonable design, easy operation, saving time and effort.

### 适用范围/SCOPE OF APPLICATION:

- 运动品牌上衣、裤子拉一、二、三条装饰贴条工艺。  
Coat, pants with 1,2,3 decorative strap.

内容/名称 Content	型号/规格 Model
大和 YAMATO	VM1806
银箭 SIRUBA	VC008
关西 KANSAI SPECIAL	KS1408
切带模式种类 cutting mode	前切(可含收料)/后切(可含收料)/前后切(可含收料)/定长切/手动切 front cutting(with fabric collection), back cutting(with fabric collection), front and back cutting (with fabric collection), fixed-length cutting, manual cutting
切带感应长度 cutting length of induction	≥10mm
切带宽度 cutting width	≤60mm
切带厚度 cutting thickness	≤3mm
最窄布片宽度 minimum fabric width	56mm
收料长度 cutting width	>250mm
适用针位 abric width	< 65mm(有效)

### 缝制实物/Sewing physical

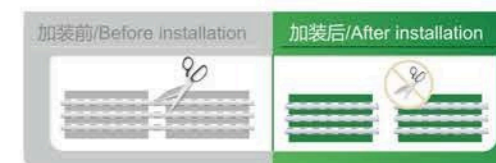
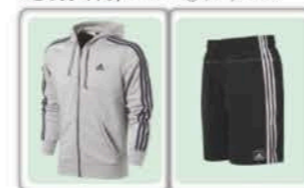

### 切带布样 / SAMPLE



切带长度最短可小于10mm  
Cutting length can be less than 10mm

# TOPDIS

## 绷缝机龙门式自动切带装置 Auto tape cutter device for interlock machine (gantry type)



切带刀组 Tape cutter assembly  
针板座 Needle plate seat  
上光眼 手动开关组 Upper sensor and hand switch  
盖板 Cover plate  
吹气组 Air releaser  
抬压脚组 Presser foot lifter assembly  
电磁阀过滤器组 Solenoid regulator assembly  
伺服电机+控制箱+操作面板 Servo motor+Control box +Operation panel

### 产品优势/ADVANTAGES:

- 刀组立式结构，左右均可过布。用于缝制其他工艺时可装置关掉，无需拆卸；  
Suncken structure, the cutter set and sewing stage are at the same level, fabric pass smoothly;
- 精确控制，自动停机、自动抬压脚，设置方便；  
Accuracy control, automatically stop working and auto foot lift, easily set;
- 传感器自动控制切带，提升效率18%左右，约4-5个月收回成本。  
Tape cutting automatically controlled by sensor, efficiency is improved around 18%, recover cost within 4-5months.

### 适用范围/SCOPE OF APPLICATION:

- 针织圆领衫后领连肩贴条、拼缝骨位包边贴条等工序。  
Back collar, cloth shoulder, patchwork edge wrapping strip of knitting round neck shirt.

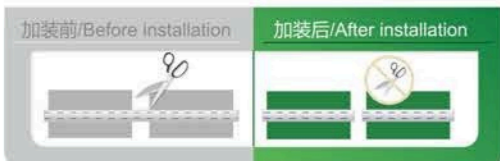

内容/名称 Content	型号/规格 Model
大和 YAMATO	VF2500/VF2402
切带模式种类 cutting mode	前切、后切、前后切、定长切、手动切 front cutting, back cutting, front and back cutting, fixed-length cutting, manual cutting
切带感应长度 cutting length of induction	1-9999针 1-9999Needle
切带宽度 cutting width	≤ 18mm
切带厚度 cutting thickness	≤ 2.5mm
最窄布片宽度 minimum fabric width	35mm
最短布片长度 minimum fabric length	20mm

### 切带布样 / SAMPLE



# TOPDIS

## 绷缝机滚领自动切带装置 Collar binding auto tape cutter device for interlock machine

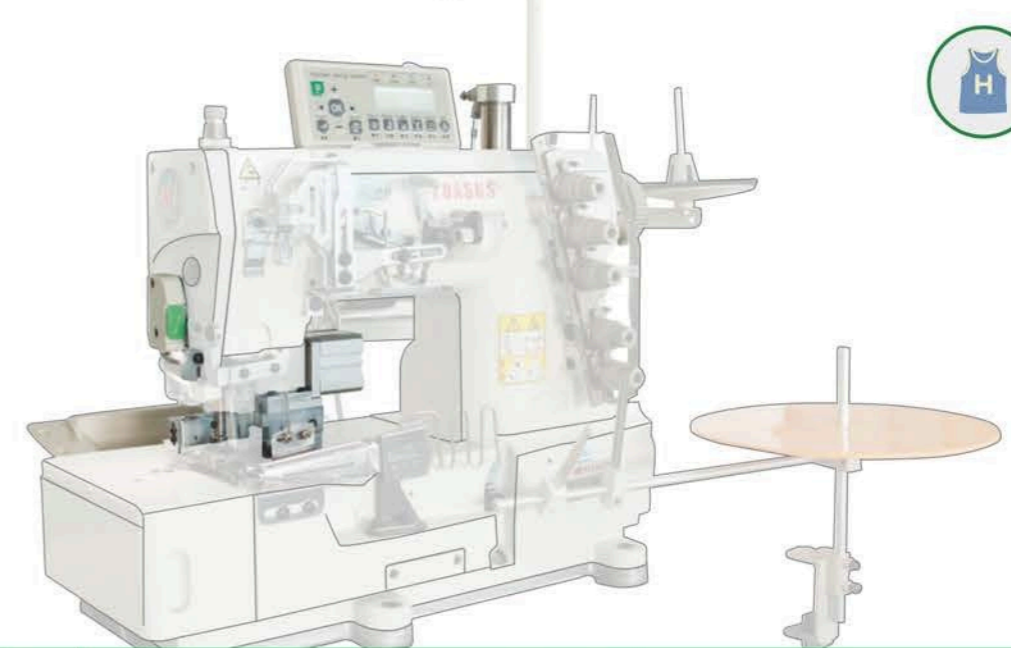

盖板 Needle plate assembly  
操作面板安装座 Operation panel fitting seat  
光眼手动开关组 sensor and hand switch  
安全开关 Safety Switch assembly  
5.6 6.4  
可选配 Optional  
切带刀组 Tape cutter assembly  
抬压脚组 Presser foot lifter assembly  
电磁阀过滤器组 Solenoid regulator assembly  
针板安装座 Needle plate install holder  
电机电控组 Servo motor Control box  
集尘组 Dust collecting

### 产品优势/ADVANTAGES:

- 刀组下沉式结构，刀组与缝台平齐，过布顺畅；  
Suncken structure, the cutter set and sewing stage are at the same level, fabric pass smoothly;
- 控制精准，自动停机、自动抬压脚，设置方便；  
Accuracy control, automatically stop easily set working and pressing and auto foot lift ;
- 连续无间隙切带，提升效率16%以上，约3~5个月收回成本。  
Continuous and uninterrupted cutting, improving the efficiency around 16%, recover the cost within 3-5months.

### 适用范围/SCOPE OF APPLICATION:

- 针织长袖、短袖保暖衣的拉领圈、后领捆条、袖口捆条；针织外套、单上衣、拉脚边、门襟拉链、袖口、长短袖，裤脚边捆条、橡筋等；婴幼儿装前中门襟、开裆位等。  
Knitting long sleeve pull collar tape, back collar bundle, cuff bundle, knitting coat, light coat, foot side puller, zipper fly, cuff, short and long sleeve, bottom side bundle, elastic etc.

内容/名称 Content	型号/规格 Model
飞马 PEGASUS	电控/膝碰/后踏款 control box/ knee touch/ back pedal
大和 YAMATO	VF2300/VF2500
银箭 SIRUBA	F007J/F858
关西 KANSAI SPECIAL	膝碰/后踏款 knee touch/ back pedal
大和 YAMATO	RX9803
	VC2700
切带模式种类 cutting mode	前切、后切、前后切、定长切、手动切 front cutting, back cutting, front and back cutting, fixed-length cutting, manual cutting
切带感应长度 cutting length of induction	1-9999针 1-9999Needle
切带宽度 cutting width	≤ 20mm
切带厚度 cutting thickness	≤ 2.5mm
最窄布片宽度 minimum fabric width	20mm
最短布片长度 minimum fabric length	20mm

### 切带布样 / SAMPLE



# TOPDIS

## 绷缝机自动防面线装置 Auto trimmer device for interlock sewing machine [Thrum clearance]

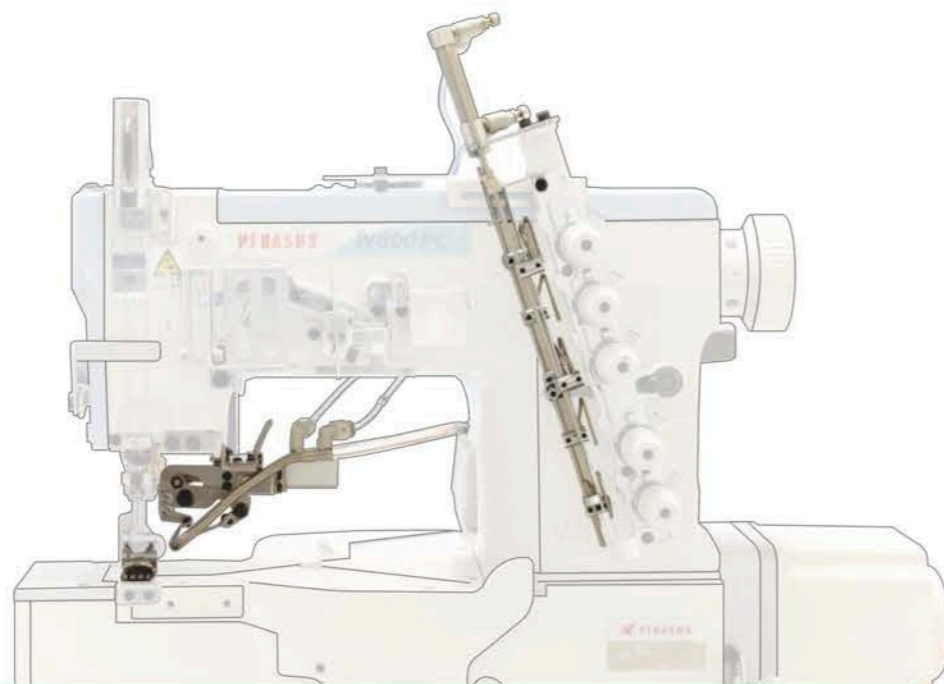
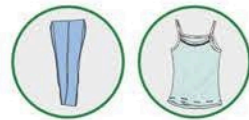

松线组  
Thread tension regulator

勾线刀组  
Trimmer assembly

压脚组  
Presser foot assembly

电控集尘组  
Electronic-control  
dust collecting

### 产品优势/ADVANTAGES:

- 勾线刀组与吸线管一体式结构，性能稳定，操作顺畅，拆装方便；  
Integrated structure of cutter set and thread suction, stable performance, easy operation and convenient disassembly and assembly;
- 刀片一体设计，锋利度高，更换方便；  
Integrated design of blade, convenient replacement, high sharpness;
- 线头小于2mm,免修剪，效率提升25%以上，3~5个月可回收成本。  
It is free clip and the thread length is less than 2mm, Improve efficiency more than 25%, It will recover the cost within 4~6 months;

### 适用范围/SCOPE OF APPLICATION:

- 针织款式所有领口、袖口、下摆，单针、双针、三针工艺等，压脚规格齐全；  
Mainly used for all knitting collars, cuffs, hem, single, double and three needles process etc, presser foot specifications complete;

内容/名称 Content	型号/规格 Model
飞马 PEGASUS	W500\W562\W600\W662
大和 YAMATO	VF2500\CF2300\VT1500 VG2700\VG3721
重机 JUKI	MF7523\MF7923
宝狮 KINGTEX	CT9000
关西 KANSAI SPECIAL	RX9803
星锐 SHING RAY	FW787

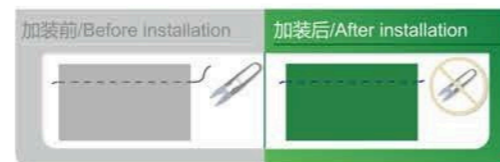

# TOPDIS

## VT1500自动切带装置 Auto tape cutter device for VT1500

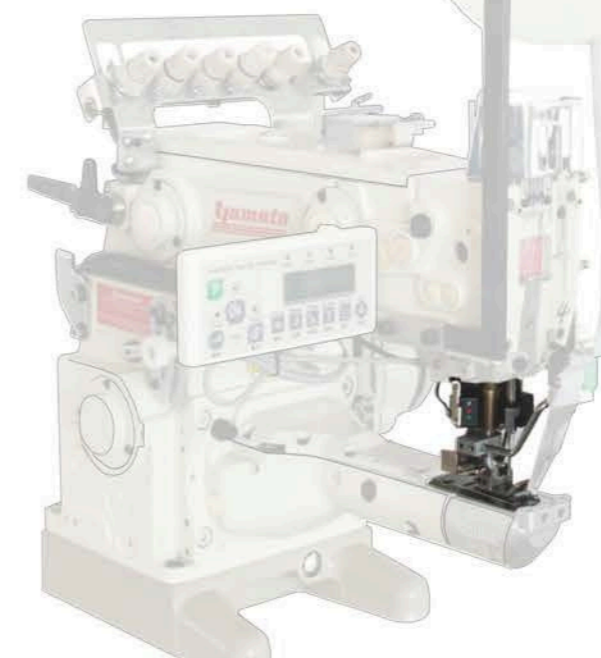

刀组  
Tape cutter

针板  
Needle plate

电磁阀  
Magnetic valve

气源处理  
Air filter

气缸组  
Cylinder group

### 产品优势/ADVANTAGES:

- 刀组立式结构，左右均可过布，用于生产缝制其它工艺时可将装置关掉，无需拆除；  
vertical structure of cutting knife structure went through smoothly by fabric could turned off when it is unnecessary to work that any other processes are working;
- 精确控制，自动停机，设备方便，节省原材料；  
controlling precisely, automatically stopping, simple structure, material saving;
- 传感器自动控制切带，提升效率20%左右，约4-5个月可回收成本。  
Working efficiency improves 20% than before for tape-cutting was controlled by sensors and cost recovery will be achieved within 4~5 months.

### 适用范围/SCOPE OF APPLICATION:

- 主要用于针织圆领衫拉肩、后领捆捆条及其它驳片装饰贴条等。  
It is mainly used in shoulder-pulling of knitting round shirt, back collar bar sewing process and decorative bar stitching process etc.



内容/名称 Content	型号/规格 Model
大和 YAMATO	VT1500\VT1502
切带模式种类 cutting mode	前切、后切、前后切、定长切、手动切 front cutting, back cutting, front and back cutting, fixed-length cutting, manual cutting
切带感应长度 cutting length of induction	1-9999针
切带宽度 cutting width	13mm
切带厚度 cutting thickness	1.2mm

# TOPDIS

## VT1500自动剪线装置 (一体刀组)

Auto trimmer device for VT1500 Feed-up-the-arm interlock stitch machine(all-in-one type)



### 适用范围/SCOPE OF APPLICATION:

- 针织款式厚料、薄料合缝后的扒缝倒骨工艺：卫衣、内衣的袖子、裤子前后浪、侧幅等。  
Seaming technology of knitting style thick&thin material after sewing joint process: hoodie, underwear sleeves, pants front and back waves, side width, etc.

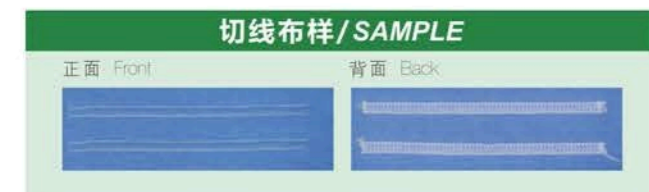

### 产品优势/ADVANTAGES:

- 电磁铁力矩大，夹线稳定，调试简单；  
It's adiveted easily with tight thread clamping and strong electromagnet working;
- 一体化设计，结构简单，安装便捷；  
Integrative design, simple structure, and easy installation;
- 直驱电机转速高达5000RPM，安全可靠；  
The direct motor's maximum speed is 5000rpm, safe and stable;

内容/名称 Content	型号/规格 Model
适用机型 Machine Model Using	大和VT1500系列(电动款/气动款) Yamato VT1500 series (Electric Type/Pneumatic Type)

# TOPDIS

## VT1500自动剪线装置 (分体刀组)

Auto trimmer device for VT1500 Feed-up-the-arm interlock stitch machine(separate type)



### 适用范围/SCOPE OF APPLICATION:

- 针织款式厚料、薄料合缝后的扒缝倒骨工艺：卫衣、内衣的袖子、裤子前后浪、侧幅等。  
Seaming technology of knitting style thick&thin material after sewing joint process: hoodie, underwear sleeves, pants front and back waves, side width, etc.

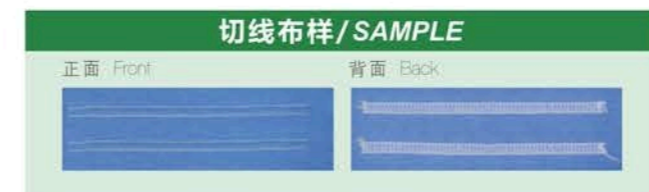

### 产品优势/ADVANTAGES:

- 电磁铁力矩大，夹线稳定，调试简单；  
It's adiveted easily with tight thread clamping and strong electromagnet working;
- 剪线速度可调，缝制更稳定；  
Trimming speed can adjust, more stable when machine is sewing;
- 直驱电机转速高达5000RPM，安全可靠；  
The direct motor's maximum speed is 5000rpm, safe and stable;

内容/名称 Content	型号/规格 Model
适用机型 Machine Model Using	大和VT1500系列【标准款/加长款】(电动款/气动款) Yamato VT1500 series [Standardized type/Extended type] (Electric Type/Pneumatic Type)

# TOPDIS

## 多针机自动剪线装置 Auto thread trimmer device for multi-needle machine

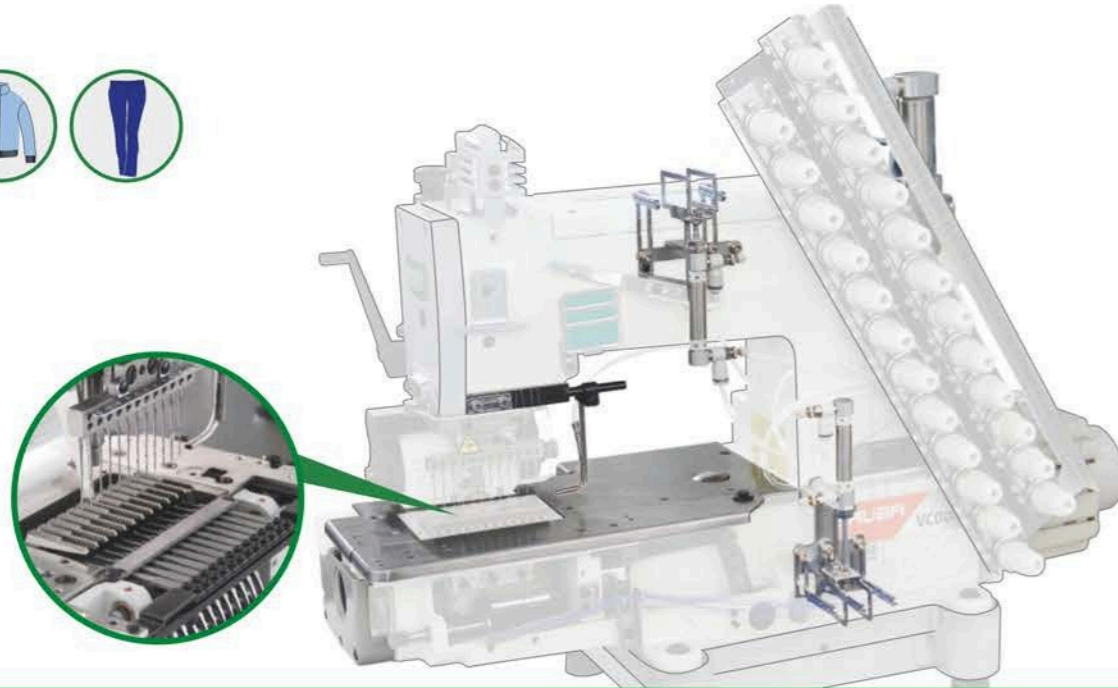

### 产品优势/ADVANTAGES:

- 实用新型剪刀，精密加工，锋利耐用，性能稳定；  
Practical and new type scissor, precision machining, sharp and durable;
- 合理设计，不破坏原机弯针结构，出刀准、速度快、不挡手，每天省线约一个左右；  
Reasonable design, do not destroy the original machine looper structure, the knife is accurate, fast, do not block the hand, saving one every day;
- 缩短设备停机时间，减轻工人劳动强度，提升工作效率15%左右，约4~6个月收回成本。  
Reduce machine downtime and labor intensity of operators, 15% improvement of efficiency, it returns back cost within 4~6 months.

### 适用范围/SCOPE OF APPLICATION:

- 上衣、袖口下摆、针/梭织套装、单衫、单裤、运动短裤、袖口、下摆、裤腰拉橡筋工艺等；  
Loat, Cuff hemming, Knit/Woven suit, shirt, shorts, trunks, cuff, waistband brace etc..

内容/名称 Content	型号/规格 Model
大和 YAMATO	VM-1804/1806
银箭 SIRUBA	VC008
关西 KANSAI SPECIAL	FX-4404/4406/4412/4413
适用针位 Identify gridding size	4针/6针/8针/10针/12针/13针 1/4, 3/8 4 / 6 / 8 / 10 / 12 / 13-needle 1/4, 3/8

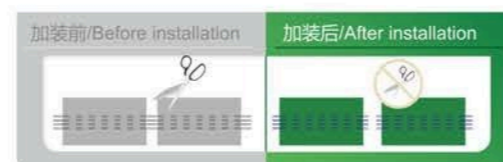
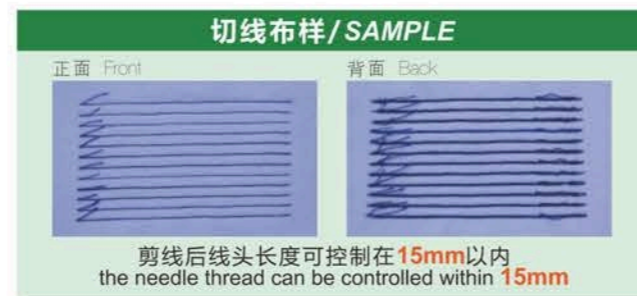

# TOPDIS

## 四针六线自动剪线装置 Four needle six thread automatic thread trimmer device

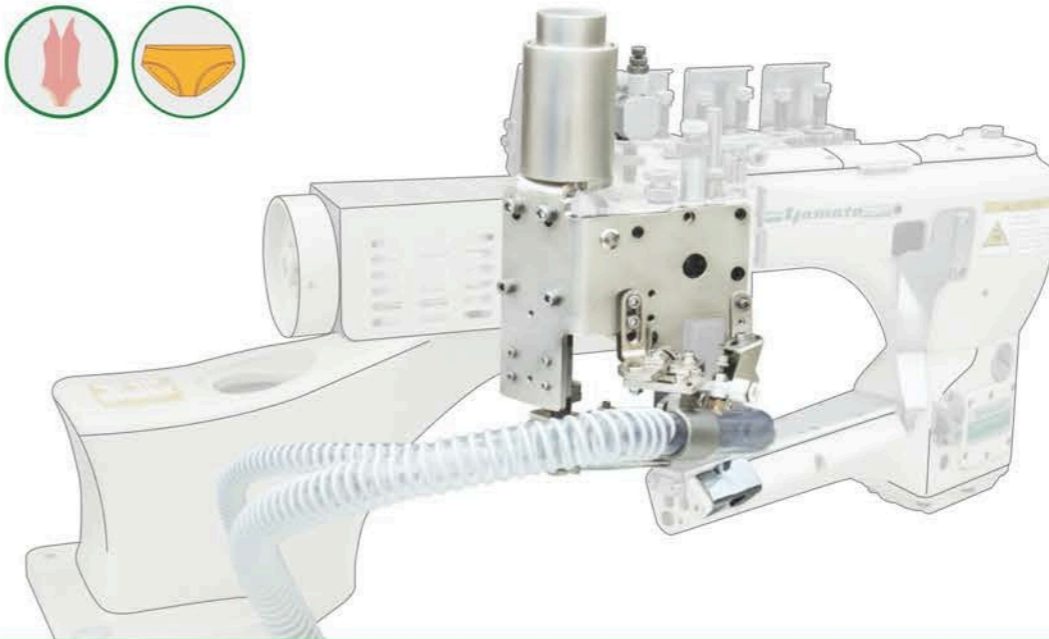
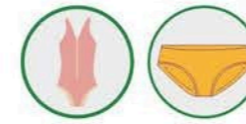

### 可选配/Optional

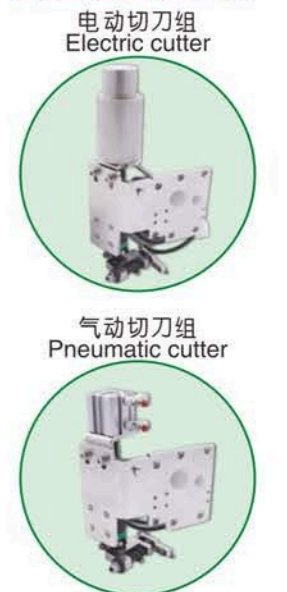

### 产品优势/ADVANTAGES:

- 结构简单，调试快捷方便，安全系数高；  
Simple structure, quick and easy adjustment, high safety factor;
- 光眼自动识别，精确控制，省时省料，线头长度小于2mm；  
Automatic sensor recognition, accuracy control, time and material saved, and left thread within 2mm;
- 吸风剪线，剪线顺畅，可设置前剪后剪，提升加工效率20%以上，约4~6个月可收回成本。  
Smoothly trimming, front and back trimmer can be set freely, improve more than 20% the processing efficiency, is can recover the cost within 4~6 months.

### 适用范围/SCOPE OF APPLICATION:

- 弹性、中弹、高弹面料款式的球衣、T恤、泳装、瑜伽服、骑车服、紧身衣、打底衫、打底裤、沙滩裤、内裤、BB装等拼接工艺。  
Elastic fabric like jersey, T-shirt, swimwear, yoga cloth, cycling suit, bodysuit, bottoming shirt, bottom pants, beach shorts, underwear etc.

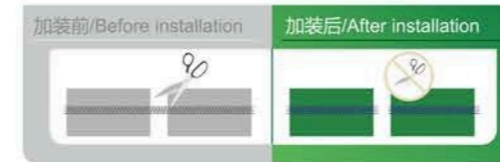

内容/名称 Content	型号/规格 Model
大和 YAMATO	FD-62G
飞马 PEGASUS	FS700P
名匠 MEGASEW	MS72/82
宝狮 KINGTEX	NTD67/68/69
星锐 SHING RAY	FW-740
前剪线模式 Front cutting pattern	光眼感应计针 / Sensor needle recorder 起缝计针 / Stitch beginning needle recorder
切线感应长度 Cutting length of thread	前切0~80针 / Front cutting 0-80 stitch 后切2~40针 / Back cutting 2-40 stitch

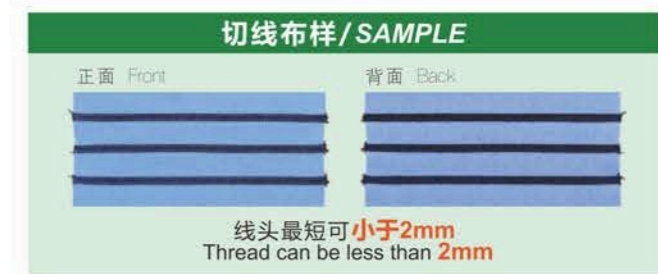

### 可选配/Optional



### 产品优势/ADVANTAGES:

1. 替代了传统的人工修剪鸟巢及线头的繁琐，为工厂提升50%工作效率。  
Replacing the traditional manual trimming of the bird's nest and thread, and improving the work efficiency of the factory by 50%;
2. 装置可选配横打、纵打配件，快速实现横打、纵打切换；  
The device can be equipped with horizontal and vertical accessories to quickly realize the switch between horizontal and vertical;
3. 装置具有专利热切技术，同时备有冷切切刀，可根据不同的加工工艺切换冷切和热切模式，使用范围更广。  
The device has patented heating technology, and is equipped with cold cutting knife, which can switch cold cutting and heating modes according to different processing technology, and has a wider range of use.
4. 对工厂的价值：无需剪线头，2-3个月左右可收回投资。  
Benefit: no need to cut the thread, about 2-3 months to recover the investment.

### 适用范围/SCOPE OF APPLICATION:

- 主要适用于内衣、女装、裤子、POLO衫、手袋等打结工艺。  
Mainly used in underwear, women's wear, pants, POLO shirts, handbags and other knotting process.

内容/名称 Content	型号/规格 Model
重机 JUKI	LK1900A/1900BN
兄弟 BROTHER	KE430D/430F
缝制样式 Sewing style	横式/纵式 Horizontal/vertical
花样起针点位置 Pattern stitch position	横打花样: X左 纵打花样: Y上 Horizontal pattern: X Vertical pattern: Y
适用花样长度 Suitable for pattern length	6-20mm
线头长度 Length of thread	<2mm
车缝速度/分钟 Sewing speed/mins	2500 ~ 3500rpm
气压 Air pressure	>0.4MPa
额定电压 Voltage	220V
频率 Frequency	50Hz

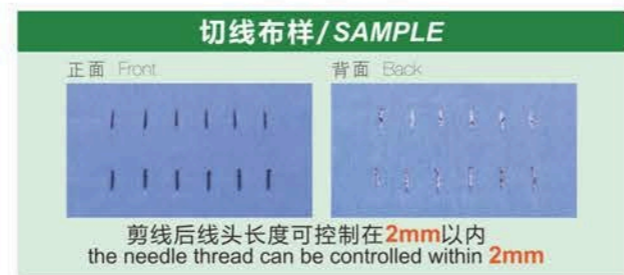

### UN1900BNP 少鸟巢装置 Less Bird's nest prevention device



结套系列  
Bartacking machine series



钉扣系列  
Button holing machine series

使用本装置,能有效防止套结(钉扣)缝纫机的开始缝制时发生的“鸟巢”现象。并通过专利切线结构,切掉多余的面线,从而提高服装的品质以及减少剪线的工序。

This device prevents the "bird's nest" that occurs on a bartacking sewing machine at the start of sewing. And through the patented thread cutting structure, Cut off redundant surface lines, So as to improve the quality of clothing and reduce the process of thread cutting.

### 使用防鸟巢装置前/Before using the less bird's nest protection device



### 使用防鸟巢装置后/After using the less bird's nest prevention device



### 智能人性化设计 Intelligent and humanized design

无论是在车缝中,碰到布料的高底过骨位置,又或者循环花样,不需要技术员二次调整,切刀位置自动适应。

Whether it is in the sewing process, when it touches the high bottom and bone position of the cloth, or when it circulates the pattern, it does not need the technician to adjust it again, and the cutter position automatically adapts.

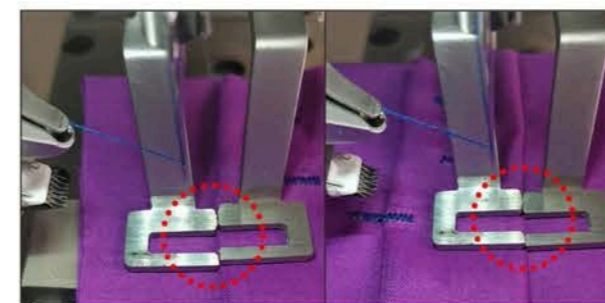

### 使用防鸟巢装置前/Before using the less bird's nest protection device



### 使用防鸟巢装置后/After using the less bird's nest prevention device



# TOPDIS

## 套结机自动剪线头装置 Automatic thread cutter device for bar-tacking machine



### 产品优势/ADVANTAGES:

- 合理结构设计，准确将四针六线的线头吸进后剪掉、包紧，配合短线头大针板使用，效果更完美；  
Reasonable structural design, suction thread accurately, cooperating with short trimming and big needle plate, all these make perfect performance.
- 采用日本进口优质高速钢刀片材料，锋利耐用，使用寿命1年以上；  
High quality, high speed steel blade material imported from Japan, sharp and durable. Its service life more than 1 year;
- 动作连贯性强，吸、剪、包加固，完成时间在2~3秒，提升效率在50%左右。  
Strong action consistency, completion time within 2~3 seconds, 50% improvement of efficiency.

### 适用范围/SCOPE OF APPLICATION:

- 四针六线缝制后下摆、袖口、脚口剪线头加固工艺等。  
Bottom, cuff, leg cuff reinforce process after 4needle 6thread machine stitching.

内容/名称 Content	型号/规格 Model
重机 JUKI	LK-1900A/1900B
兄弟 BROTHER	KE-430D/430F

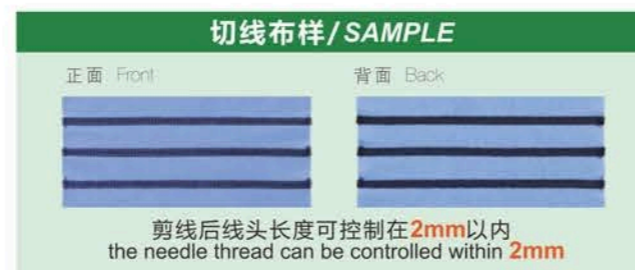

# TOPDIS

## 电脑平车自动切带装置 Auto tape cutter device for computerized lockstitch machine

### 可选项/Optional 切带刀组-A款 Tape cutter assembly-Type A



### 切带刀组-B款 Tape cutter assembly-Type B

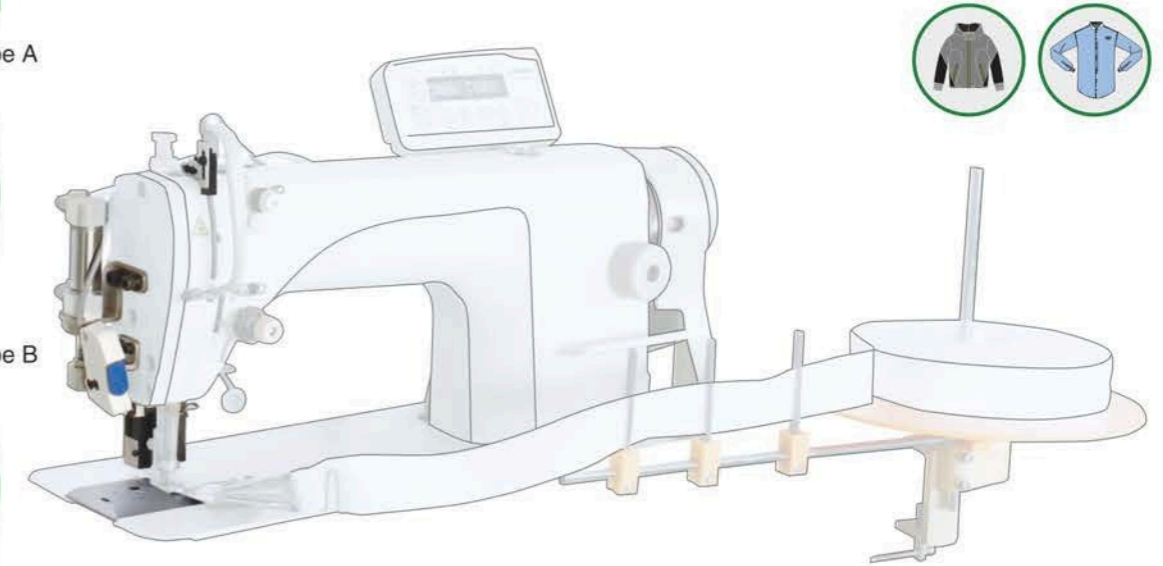

### 产品优势/ADVANTAGES:

- 刀组立式结构，左右均可过布，不挡手。缝制其他工艺时可直接将装置关掉，无需拆卸，灵活性强；  
Vertical structure of cutter assembly, cloth can pass through the left and right side, don't block hand, used for other process, can switch off the device, no need to remove;
- 精确控制，切带长度差异仅为1针；  
Accurate control, band length difference controlled in 1 stitch;
- 传感器自动控制切带，节省时间，效率提升15%以上，约3~4个月收回成本。  
Auto-cutting controlled by sensor, improve the efficiency around 15%, It will recover the cost within 3-5 months.

### 适用范围/SCOPE OF APPLICATION:

- 针梭织面料包边拉脚边工序，衬衣袖叉、门禁拉链、防晒服骨位、旗袍、休闲裤、西裤袋布包边捆条；T恤、套装、家居服拉脚边条等。  
Overeding, shirts' cuff, front fly zipper, sun-proof clothing seaming, wrapping strip of pocket of cheongsam, casual pants, suit pants; edgings of T-shirt, suit, housecoat etc.

内容/名称 Content	型号/规格 Model
兄弟 BROTHER	S-7200/7250/7300
重机 JUKI	DDL-8700/900A/9000C
切带模式种类 cutting mode	前切、后切、前后切、定长切、手动切 front cutting, back cutting, front and back cutting, fixed-length cutting, manual cutting
切带感应长度 cutting length of induction	1-99针/Needle
切带宽度 cutting width	≤12mm
切带厚度 cutting thickness	≤2.5mm
最窄布片宽度 minimum fabric width	30mm
最短布片长度 minimum fabric length	10mm

### 切带布样/SAMPLE



# TOPDIS

## 双针机自动切带装置 Auto tape cutter device for double needle machine

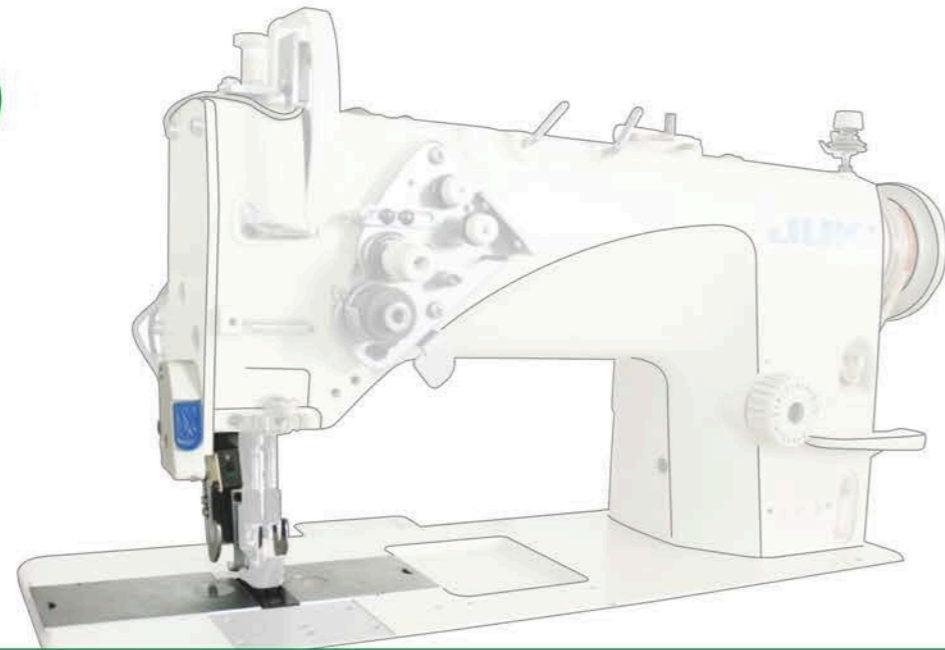

### 产品优势/ADVANTAGES:

- 刀组立式结构，左右均可过布，不挡手，空间大；  
Vertical structure of cutter assembly, the cloth can pass through the left and right side, don't block hand, large space;
- 精准控制，切带长度差异仅为1针；  
Accurate control, band length difference controlled in 1 stitch;
- 传感器自动控制切带，节省时间，效率提升15%以上，约3~5个月收回成本。  
Auto-cutting controlled by sensor, improve the efficiency around 15%, recover the cost within 3-5 months.

### 适用范围/SCOPE OF APPLICATION:

- 梭织面料拉裤耳、童装/运动装/内衣，针织开筒衫下级领、门筒落织带贴条工艺等。  
Woven material, belt-loop, children's clothes/sportswear/underwear, knit opener shirt lower collar, ribbon sewing etc.

内容/名称 Content	型号/规格 Model
重机 JUKI	LH-3568/LH-3578
兄弟 BROTHER	T-8450/T-8452
切带模式种类 cutting mode	前切、后切、前后切、定长切、手动切 front cutting, back cutting, front and back cutting, fixed-length cutting, manual cutting
切带感应长度 cutting length of induction	1-99针/1-99Needle
切带宽度 cutting width	≤15mm
切带厚度 cutting thickness	≤2.5mm
最窄布片宽度 minimum fabric width	20mm
适用针位 gauge set	1/4 3/8 3/16

### 切带布样/SAMPLE



切带最短可**小于4mm**  
Cutting length can be less than **4mm**

加装前/Before installation 加装后/After installation



# TOPDIS

## 人字车自动切带装置 Auto tape cutter device for zigzag sewing machine

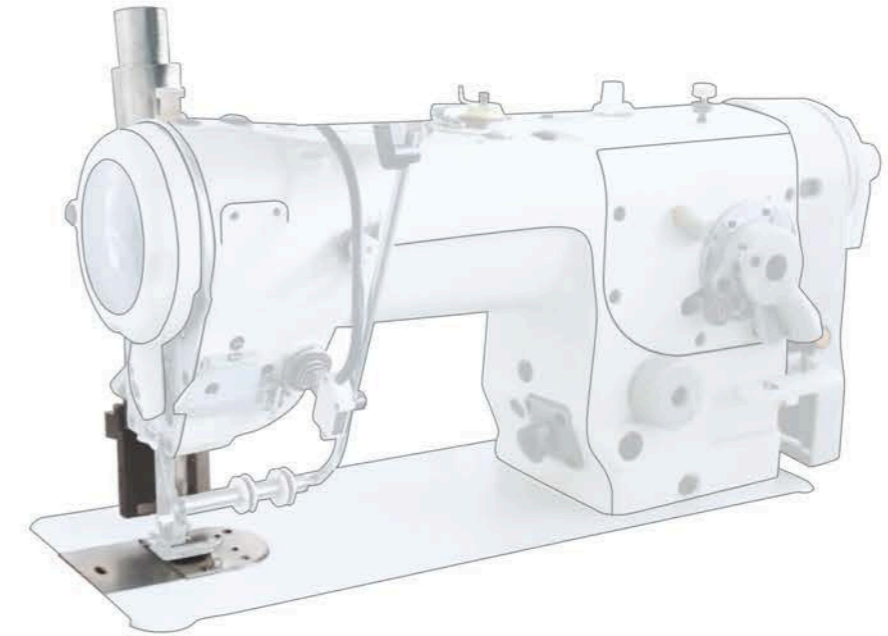

### 产品优势/ADVANTAGES:

- 刀组立式结构，左右均可过布，不挡手，空间大；  
Vertical structure of cutter assembly, the cloth can pass through the left and right side, don't block hand, large space;
- 精确控料，切带长度根据工艺要求设定，差异仅为1针；  
Accuracy control, cutting belt length can be set according to the technological requirements, tolerance only one stitch;
- 传感器自动控制切带，节省时间，效率提升18%左右，约3-4个月收回成本。  
Sensor controls the cutting belt automatically, improve efficiency around 18%, and recover the cost within 3-4 months.

### 适用范围/SCOPE OF APPLICATION:

- 针织面料内衣裤、泳装、保暖衣落弹力文巾带、织带等工序。  
Knitting underwear, swimwear, thermal clothing falling stretch towe, ribbon wearing etc.

内容/名称 Content	型号/规格 Model
重机 JUKI	LZ-2284/2290
切带模式种类 cutting mode	前切、后切、前后切、定长切、手动切 front cutting, back cutting, front and back cutting, fixed-length cutting, manual cutting
切带感应长度 cutting length of induction	1-99针/1-99Needle
切带宽度 cutting width	≤30mm
切带厚度 cutting thickness	≤2mm文巾带Towel
最窄布片宽度 minimum fabric width	30mm

### 切带布样/SAMPLE



切带最短可**小于4mm**  
Cutting length can be less than **4mm**

加装前/Before installation 加装后/After installation





### 装置功能/FUNCTION:

电脑自动剪线平缝机在起缝时，布料下面会形成线团，俗称鸟巢。

At the beginning stitch of the computerized automatic cutting lockstitch machine, there's a lot of coils under the fabric, we calls anti bird nest.



使用防鸟巢装置前  
Without anti bird nest device

加装防鸟巢装置,可彻底解决起缝产生多余面线的问题,同时避免鸟巢的产生,将多余面线剪掉吸走,提高缝制质量,省去手工挑剪线头工序,节约费用。

It can completely solve redundant thread by sucking them away. when the machine start sewing meanwhile avoid bird nest to improve sewing quality, save manual trimming and save cost.



使用 **STRONG H** 防鸟巢装置后  
with **STRONG H** anti bird nest device

### 产品优势/ADVANTAGES:

- 采用半圆形割线刀片，寿命比市场常规品高10倍以上；  
With semi-circular secant blades ,the lifetime is more than 10 times higher than conventional products in the market;
- 后拉款不占用机体下侧操作空间，不挡手，可顺利缝制各种平车工序；  
No operating space on the lower side of the machine occupied, feeding fabric fluently, is could sew variety of working procedure lockstitch smachine;
- 割线头长度可小于2mm,免修剪，4~6个月可收回成本；  
The secant length is less than 2mm to be freely clipped.The cost recover ing can be realieed witnin 4~6 months;
- 部件一体化设计，结构合理，安装简单，每套安装调试时间不到半小时。  
It is easily installed that the installing time of each set is less than half an hour because of its integrated component design, rational construction.

### 适用范围/SCOPE OF APPLICATION:

- 针织、梭织、订唛头、领脚捆条织带、帽边、车脚边、贴袋、门襟、门筒、袖口、袖介英工艺等。  
Mainly used for knitting and weaving, such as shipping mark stitching, collar tape, hat side, hemming side,patch pocket, garment closing , placket, sleeve opening, cuff etc.
- 国内外各品牌电脑自动剪线平缝机。  
Apply to computerized lockstitch sewing machine both domestic and foreign brand.

### 适配压脚系列/ PRESSOR FOOT SERIES



普通平压脚  
Common flat  
presser foot



拉链压脚  
Zipper presser  
foot

左右高低压脚  
规格:1/32 1/16 3/16 1/8 1/4  
Right or left uneven  
presser foot



小针距压脚  
Small stitch presser foot  
(3mm)



左右挡边压脚  
规格:1/32 1/16 3/16 1/8 1/4  
Presser foot with right  
or left guard



塑料平压脚  
Plastic flat presser foot



普通平压脚  
Common flat  
presser foot



拉链压脚  
Zipper presser  
foot

左右高低压脚  
规格:1/32 1/16 3/16 1/8 1/4  
Right or left uneven  
presser foot



小针距压脚  
Small stitch presser foot  
(3mm)



左右挡边压脚  
规格:1/32 1/16 3/16 1/8 1/4  
Presser foot with right  
or left guard



塑料平压脚  
Plastic flat presser foot



# TOPDIS

## 380链式自动剪线装置 380 automatic trimming/tape cutter chainstitch machine

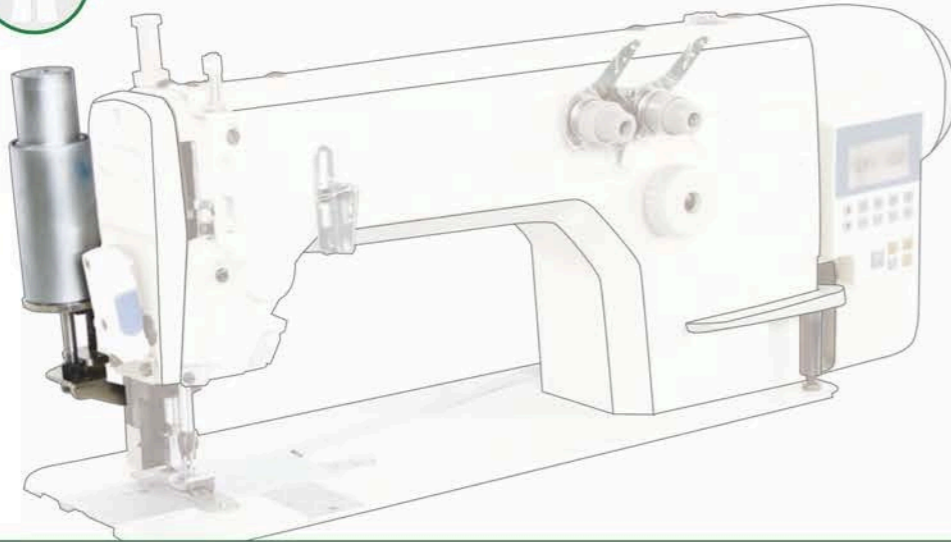

### 可选项/Optional

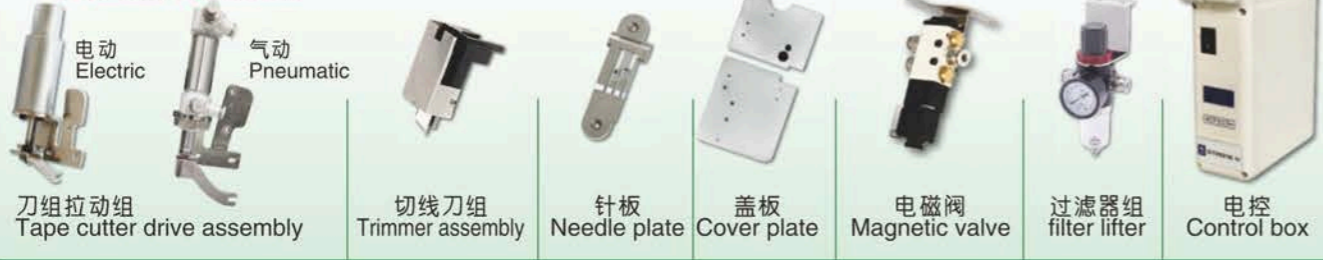

### 产品优势/ADVANTAGES:

- 刀组立式结构，过布顺畅，可缝制各种不同规格形状的裁片，刀组距针板最高可调至10mm；  
Vertical structure of cutter assembly, the cloth passes smoothly, sewing various shapes and standards of pieces, no limit of length or size, the maximum distance between cutter set and needle plate can be adjusted to 10mm;
- 后踏控制切线长短，不用时可将切线功能关掉，不影响操作，灵活性强；  
The rear step controls the length of the tangent. There is no need to raise the structure at all times and to dismantle. It doesn't affect the sewing operation and maintenance;
- 操作方便，转速高达4000RPM，省时省力，提升效率15%以上，约3~4个月收回成本。  
Easily sewing, rotating speed up to 4000RPM, less labor and time, improves more than 40% efficiency, and recover the cost within 3~4 months.

### 适用范围/SCOPE OF APPLICATION:

- 牛仔、休闲、T恤、羽绒服、雨伞拼缝及装饰线等。  
Jeans, sports wear, T-shirt, down jacket, flat-fell seam umbrella and decorative thread etc.

内容/名称 Content	型号/规格 Model
重机 JUKI	MH-380/382/481
适用针位 Cutting thickness	单针/双针/纵向双针 1/4、3/16、3/8 品3针/斜3针 1/4、3/8 Single needle/double needle/ lengthways double needle 1/4、3/16、3/8 Two types of three needle 1/4、1/8

### 切线布样/SAMPLE

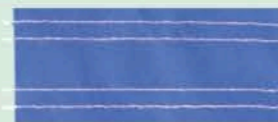

线头最短可小于10mm  
Thread can be less than 10mm



# TOPDIS



UN-2518/2516/1816  
柔性材料自动裁切机  
Soft material cutter



UN-XM1509/XM1512/XM1809/  
XP1509/XP1512/XP1809  
高速模板切铣机  
High speed template cutting and milling machine



UN-P1509/P1512/P1809/  
M1509/M1512/M1809  
经典系引模板切铣机  
Classic template cutting milling Machine

## TAILORING SCISSORS 裁缝剪系列



## TWEEZERS / SCISSORS / MEASURING TAPE 镊子/纱剪/皮尺



DOL 13H



YL 4824



UN-JN550



UN-JN684



### 特点:

1. 采用先进的计算机辅助设计, 具有温升低、噪音小、振动低、力矩大, 起制动灵敏及过载能力大等优点;
2. 性能稳定可靠, 使用方便, 产品规格齐全。

### FEATURES:

1. Adopt of advanced computer aided design, with low temperature, low noise, small vibration, torque, start-stop sensitive and overload capacity.
2. The performance is stable and reliable, easy to use.

### 规格表 / SPECIFICATION

型号 Model	名称 Name	电压 Voltage	功率 Power	转速 Model
DOL13H	工业离合器马达 "V" 型 Industrial clutch motor "V" type	220V/2P	250W/50Hz	2850rpm
AOL12H	工业离合器马达 "V" 型 Industrial clutch motor "V" type	380V/2P	370W/50Hz	2850rpm
DOL13H	工业离合器马达 "V" 型 Industrial clutch motor "V" type	220V/2P	250W/50Hz	2850rpm
AOL12H	工业离合器马达 "V" 型 Industrial clutch motor "V" type	380V/2P	370W/50Hz	2850rpm
DOL13L	工业离合器马达 Industrial clutch motor	220V/4P	250W/50Hz	1425rpm
AOL13L	工业离合器马达 Industrial clutch motor	380V/4P	250W/50Hz	1425rpm
DOL12L	工业离合器马达 Industrial clutch motor	220V/4P	400W/50Hz	1425rpm
AOL12L	工业离合器马达 Industrial clutch motor	380V/4P	400W/50Hz	1425rpm

# NEEDLE PLATE

## 针板系列

精益求精，卓越追求，缝纫更精确.....  
Excellence, sewing more precise.....

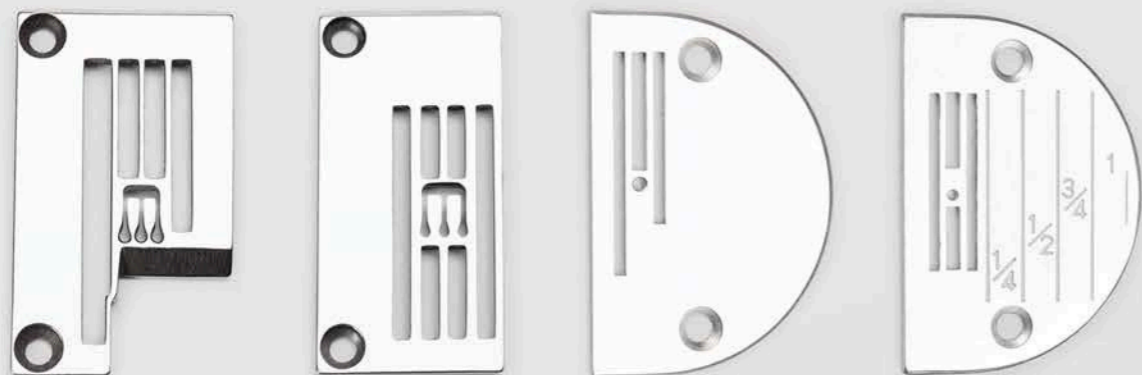
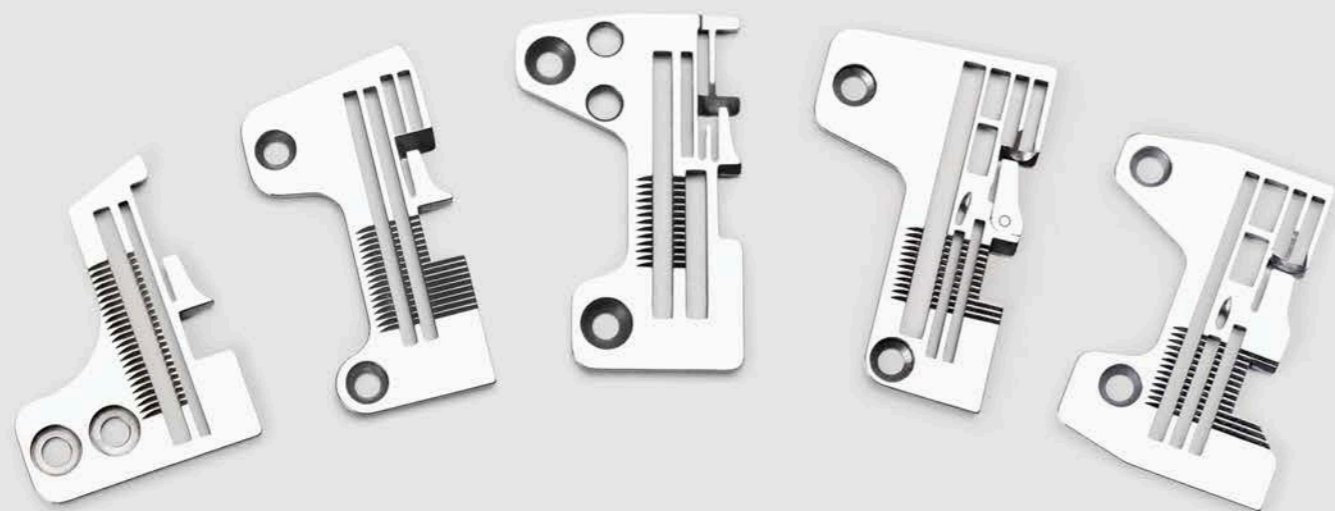

FOR BROTHER 兄弟

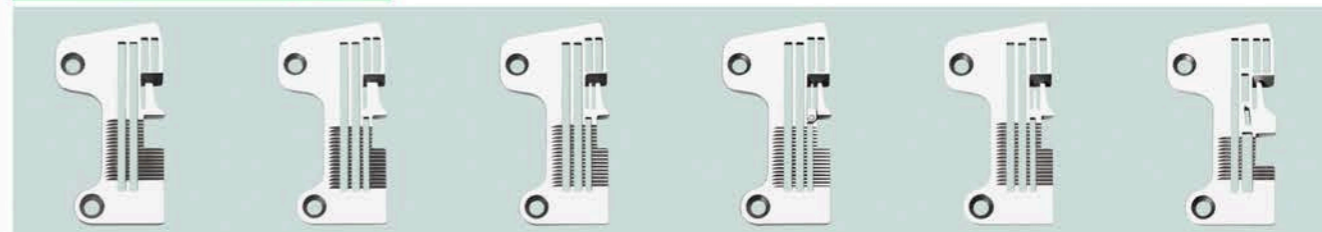

146730-001 B511-001-3	146734-001 B511-002-5	146781-001 B531-002-5	S01711-001 B531-022-5	146786-001 B531-033-5	146498-001 B551-062-3
146731-001 B511-001-4	146735-001 B511-002-6	146782-001 B531-022-6	S01713-001 B531-022-6		
146732-001 B511-001-5	146736-001 B511-002-7	146783-001 B531-027-7	S01715-001 B531-027-7		
146733-001 B511-001-6	146737-001 B511-009-5				

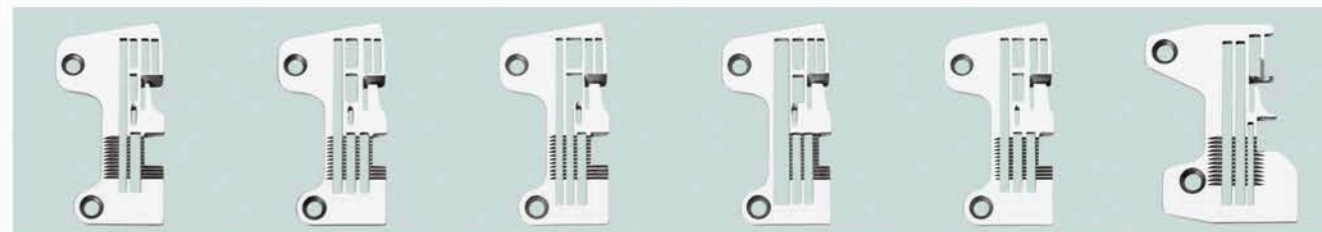

146501-001 B551-063-3	146504-001 B551-065-5	146508-001 B551-069-5	148398-001 (S01774-001)B551-071-5	147783-001 B551-087-5	S33023-001 EF4-N11-01-3
146502-001 B551-063-4	146505-001 B551-065-6	S01773-001	146509-001 (S01775-001)B551-071-6	146510-001 B551-087-6	S19145-001 EF4-N11-01-4
146503-001 B551-064-5				159769-001 B551-087-5S	S19146-001 EF4-N11-01-5
				159770-001 B551-087-6S	S25185-001 EF4-N11-01-6



S31975-001 MA4-N31-95-5	S25190-001 EF4-N21-22-4	S19169-001 EF4-N21-41-5	S19185-001 EF4-N31-92-5	S20231-001 EF4-N31-65-4
	S19162-001 EF4-N21-22-5	S19170-001 EF4-N21-41-6	S19186-001 EF4-N31-92-6	S20232-001 EF4-N31-65-5
	S19163-001 EF4-N21-22-6	S25193-001 EF4-N21-41-7	S25187-001 EF4-N31-92-7	S20233-001 EF4-N31-65-6
	S25191-001 EF4-N21-22-7			D25197-001 EF4-N31-65-7



S20234-001 EF4-N31-65-3	S08717-001 FD4-B272-011-1	S08722-001 FD4-B272-011-6	S08730-001 FD4-B272-021-6	S08733-001 FD4-B272-031-3
S20235-001 EF4-N31-65-4	S08718-001 FD4-B272-011-2	D08723-001 FD4-B272-011-7	S08731-001 FD4-B272-021-7	S08734-001 FD4-B272-031-4
S20236-001 EF4-N31-65-5	S08719-001 FD4-B272-011-3	S08724-001 FD4-B272-011-8	S08732-001 FD4-B272-021-8	S08735-001 FD4-B272-031-5
D25196-001 EF4-N31-65-6	S08720-001 FD4-B272-011-4			
	S08721-001 FD4-B272-011-5			



S08736-001 FD4-B272-031-6	S08744-001 FD4-B272-071-6	145246-001 B814	S10570-001	S10572-001	S10573-001
S08737-001 FD4-B272-031-7	S08745-001 FD4-B272-071-7				
S08738-001 FD4-B272-031-8	S08746-001 FD4-B272-071-8				

### FOR BROTHER 兄弟



B12 B14 B16 B18  
B20 B22 B24 B26  
B28 B30 B33

A12 A14 A16 A18

E12 E14 E16 E18  
E20 E22 E24 E26  
E28

AB12 AB14 AB16 AB18

E型  
E type

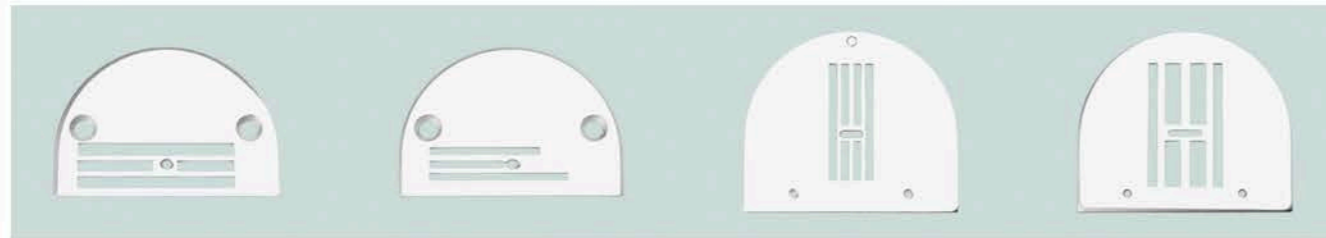

H26 157092

C26 C33

112795-0-01 (5mm)

112802-0-01 (8mm)



S07318-2-01

LT2-B842-3

S07325-2-01

152995-0-01

### FOR PEGASUS 飞马



202546E L52-17

202616 L52-01(2mm)  
202617 L52-01(3mm)  
202618 L52-01(4mm)

202702 R53-05  
202675 R53-05

209298 L52-01(2mm)  
209299 L52-01(3mm)  
205773 L52-01(4mm)

205465 L52-16

208753 L52-13  
202554E L52-13



205255 L52-13

204731A L52-17(8mm)

165309 L32-355  
208648 L32-355  
208764 L32-355  
208675

204366 L32-38  
204367 L32-38  
204368 L32-38  
204369 L32-38

204528 L32-86  
204529 L32-86  
204700 L32-86

204358A L32-70(3mm)  
204359A L32-70(4mm)  
204360A L32-70(5mm)  
204361A L32-70(6mm)

### FOR PEGASUS 飞马



204380 L32-74  
204381 L32-74

204939 L32-48(3mm)  
204940 L32-48(4mm)  
204941 L32-48(5mm)  
204942 L32-48(6mm)

210783 E52-211  
210784 E52-211

210796 E52-130  
210797 E52-130

210804 E52-132  
210805 E52-132

210799 E52-130  
210800 E52-130

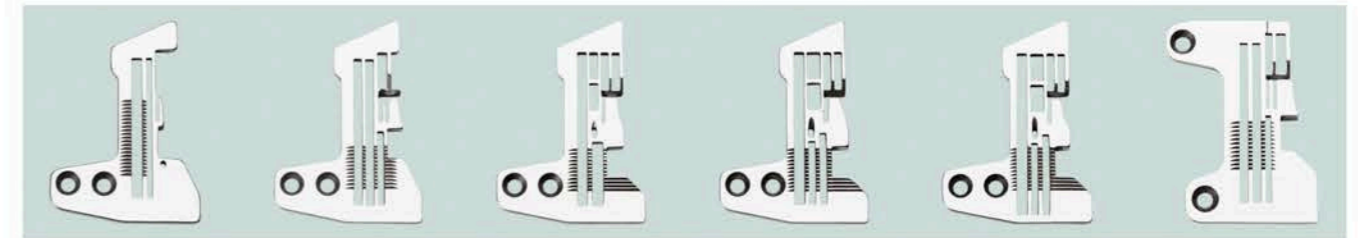

210934 E52-231

210809 E52-131  
210810 E52-131

210837 E32-420  
210838 E32-420  
210839 E32-420

210867 E32-451  
210868 E32-451

210986 E32-452  
210987 E32-452

277505R30 EX5214(3mm)  
277505R40 EX5214(4mm)  
277505R50 EX5214(5mm)

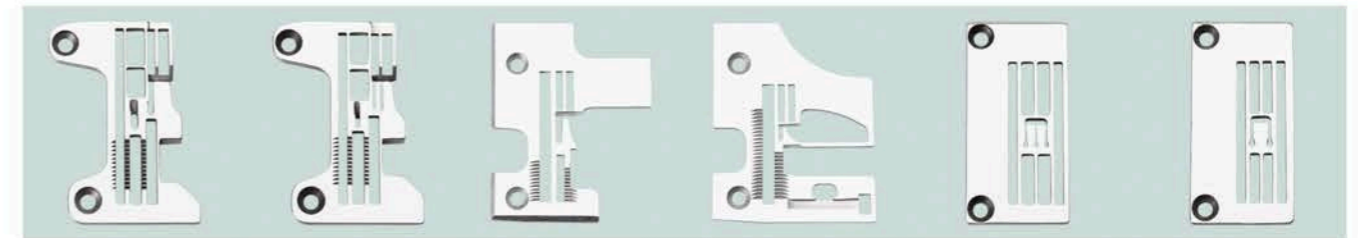

277524T50 EX3216H(5x5)  
277524T60 EX3216H(5x6)

277518R40 EX3244-03  
277519R40 EX3244-03

200954 DCM-204  
140135 DCM-204

200044A DCP-101

206276 W61-01(3x5.6)  
206277 W61-01(3x6.4)

257015B32 W561-01(2x3.2)  
257015B40 W561-01(3x5.6)  
257015B48 W561-01(3x6.4)  
257017B56 W561-01(3x5.6)  
257017B64



257016B48 W561-01(3x4.8)  
257018B56 W561-01(3x5.6)  
257018B64 W561-01(3x6.4)  
257022B56 W561-01(3x5.6)

257099B48 W664-03(2x4.8)  
257096B56 W664-03(2x5.6)  
257096B64 W664-03(2x6.4)  
257097B56 W664-03(3x5.6)  
257097B64 W664-03(3x6.4)

257018B56-N

257089B56 W541-03(2x5.6)  
257089B64 W541-03(2x6.4)  
257090B56 W541-03(3x5.6)  
257090B64 W541-03(3x6.4)

257095B40 257095B48  
257095B56 257095B64

257108B56 W664-08(3x4.8)  
257108B64 W664-08(3x6.4)

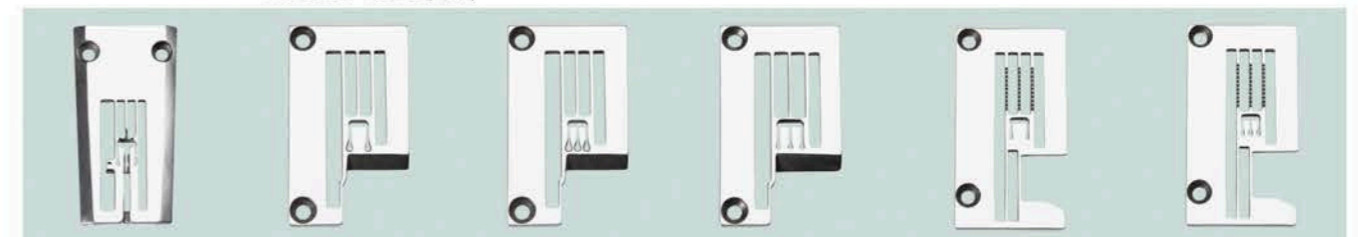

236035B40 W603(3x4.0)  
236035B48 W603(3x4.8)  
236035B56 W603(3x5.6)  
236035B64 W603(3x6.4)

257029B24 W561-02(2x2.4)  
257029B32 W561-02(2x3.2)  
257030B40 W561-02(2x4.0)  
257030B48 W561-02(2x4.8)  
257032B56 W561-02(2x5.6)  
257032B64 W561-02(2x6.4)

257031B48  
257031A48

257033A56 W561-02(3x5.6)  
257033B56 W561-02(3x5.6)  
257033A64 W561-02(3x6.4)  
257033B64 W561-02(3x6.4)

257049B24 W561-05(2x2.4)  
257049B32 W561-05(2x3.2)  
257050B40 W561-05(2x4.0)  
257050B48 W561-05(2x4.8)  
257052B56 W561-05(2x5.6)  
257052B64 W561-05(2x6.4)

257051B48 W561-05(3x4.8)  
257053B56 W561-05(3x5.6)  
257053B64 W561-05(3x6.4)

### FOR PEGASUS 飞马

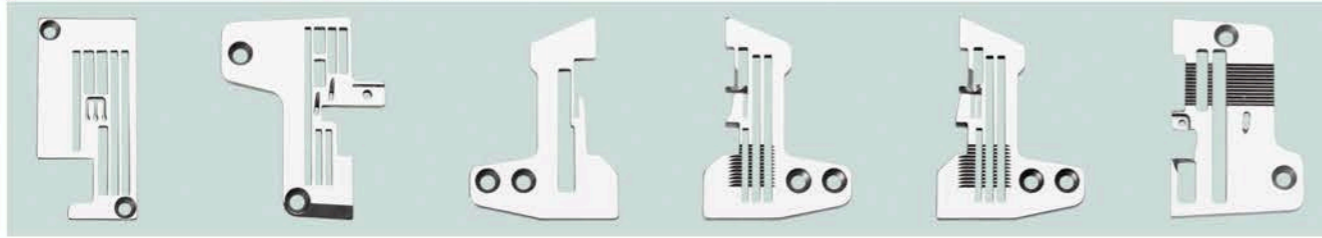

257102B56 W664-35(3x5.6) 208567 211601 211726 211731 630120  
 257102B64 W664-35(3x6.4)

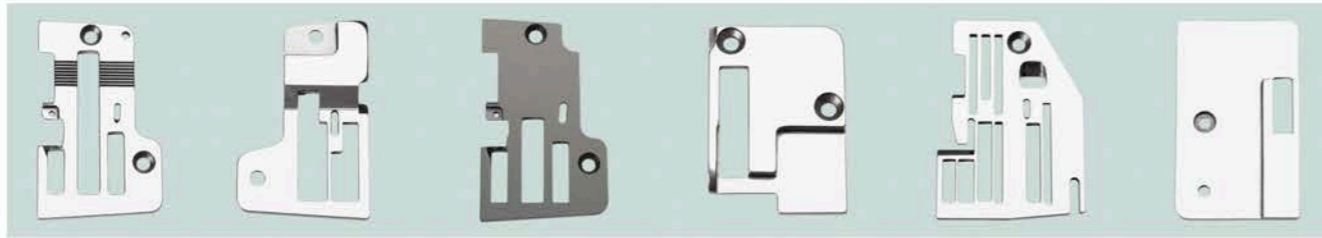

660001 660002 650075 626373 A91-150-809-D5 AC18040M 660003

### FOR YAMATO 大和

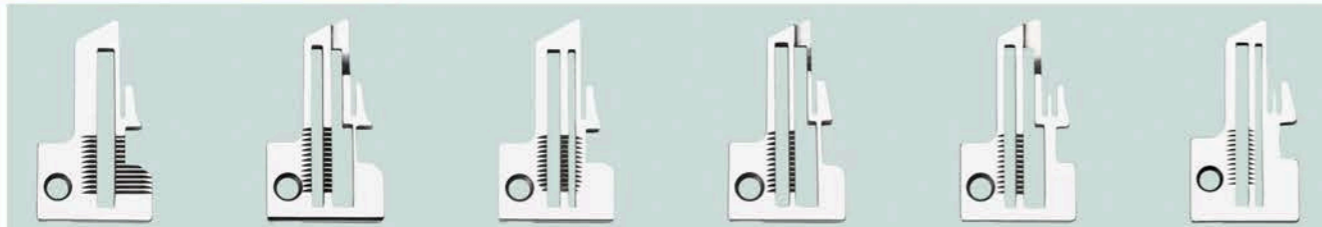

Y32666 DCZ-200-D1 Y32670 DCZ-203 Y34893 DCZ-200-1-D1 Y39524B 3/32" 39500-B Y33353 DCZ-220-D1 Y204800  
 Y32667 DCZ-200-D2 Y32671 DCZ-203 Y34894 DCZ-200-1-D2 Y39524B 5/32" 39500-B Y32678 DCZ-220W-D1  
 Y32672 DCZ-203 Y32673 DCZ-203 Y39524B 1/8" 39500-B Y33821 DCZ-221-D1  
 Y39524B 3/16" 39500-B  
 Y39524V 1/8" 39500-V



Y33540 DCZ-361A-D1(3.2x1) Y33545 DCZ361C-D3(5x3) Y35334 DCZ-341C Y2108000 AZ-6000H-04 Y2108002 AZ-6003H-03 Y2108003 AZ-6003H-04  
 Y33541 DCZ-361A-D2(3.2x2) Y36590 Z367-C5GF(5x5) Y2108001 AZ-6000H-03 Y2108007 AZ-6003H-05 Y2108012 AZ-6003H-06  
 Y33542 DCZ-361Y-D1(2.4x1) Y33543 DCZ-361T-D2(2.4x2) Y36568 Z100-A2DF(3.2x2) Y36569 Z100-A3DF(3.2x3) Y36570 Z100-A4DF(3.2x4)

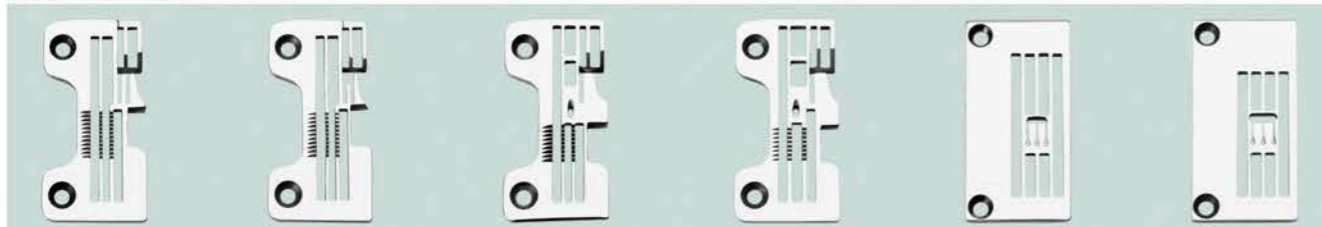

Y2108005 AZ-8020H-Y6 Y2108006 AZ-8020H Y2108050 AZ-8500H-A4 Y2108051 AZ-8500H-A5 Y210876 AZ800H Y94800 DW-1350-MC Y90166 DW-100(7/32")  
 Y94801 DW-1350-MD Y90167 DW-100(1/4")  
 Y94802 DW-1350-ME

### FOR YAMATO 大和



Y93170 DV-1400(2x3.2) Y94801-L2 Y94801-L2-05 Y94801-N Y3108134 VC-2700(3x5.6)  
 Y93171 DV-1400(2x4.0) VF-2500(3x5.6) VF-2500(3x5.6) VF-2500 Y3108135 VC-2700(3x6.4)  
 Y93172 DV-1400(2x4.8)  
 Y93173 DV-1400(2x5.6)  
 Y93174 DV-1400(2x6.4)

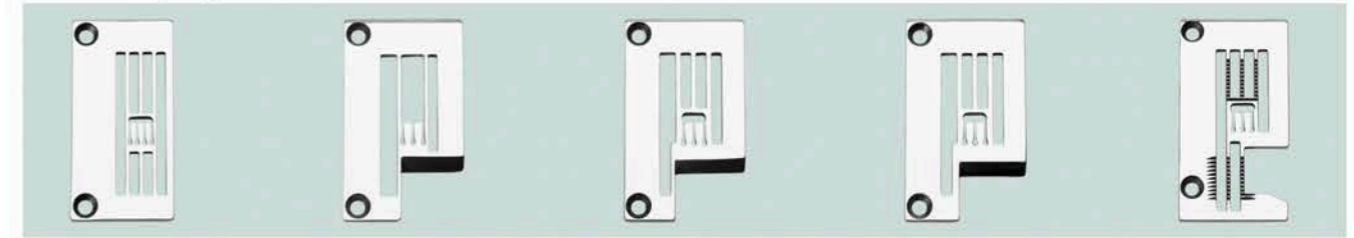

Y3108136(4x6.0) Y90556 DW-303(7/32") Y95085 Y91764 DW-103(7/32") Y95278 DW-1509(3x5.6)  
 Y90557 DW-303(1/4") DW-1503(7/32") Y91765 DW-103(1/4") Y95279 DW-1509(3x6.4)  
 Y91676 DW-103



Y3268014 VFS-2511(3x6.4) 3158012 VE-2713-156S(3x5.6) Y3118025 VC-3711(2x6.4) Y37483 DCY-104

### FOR JUKI 重机



B1136-357-A00 MO-357A R4200HODDAA MO-2504-OD4 R4205HODE00 MO-2514-BD4-200 R4305HOFEE00 MO-2514-BF6 R4508HODD00 MO-2516-DD4  
 B1136-357-B00 MO-357B R4200HODD00 MO-2504-OD4-200 R4205HODEA0 MO-2514-BD4 R4305HOEE00 MO-2514 R4508HODDAA MO-2516  
 B1136-357-C00 MO-357C R4200HOED00 MO-2504-OE4-300 R4205HEEO0 MO-2514-BE4-300 R4305HODE00 MO-2514-BD6 R4508HOFD00 MO-2516-DF4  
 R4200HOFD00 MO-2504-OF4-300 R4305HODE0A MO-2514-BD6



R4608HODFOO MO-2516-DD6 R4608HOFGOO MO2516-DF6 R4612HOFBOO MO-2516-FF6-100 R4200JODD00 MO-3904-OD4 R4305JODE00  
 R4612HOFGOO MO-2516-FF6-500 R4200JOED00 MO-3904-DE4 R4305JOEE00  
 R4305JOFEE00 MO-3914-BD6  
 R4305JOFEE00 MO-3914-BD6

### FOR JUKI 重机

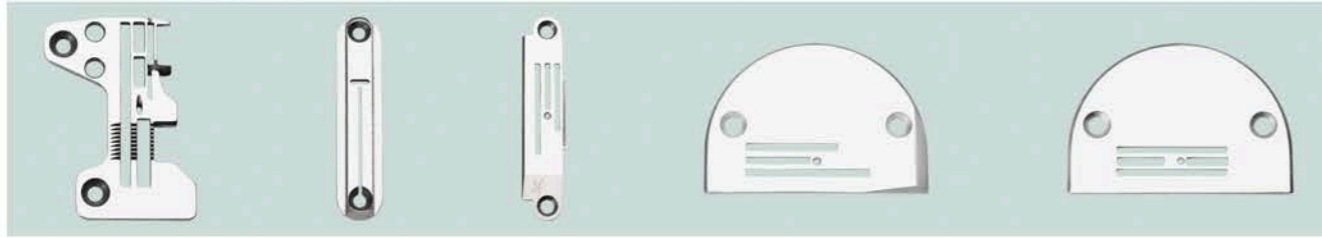

R4508JODDOO MO-3916-DD4  
R4508JOEDOO MO-3914-DE4  
R4508JOFDOO MO-3914-DF4  
R4508JOEDOC MO-3914-DF4

B2402-771 LBH-771

B1190-522-UOO DLM-5200-1/4

B1109-012-A00

B1109-012-100

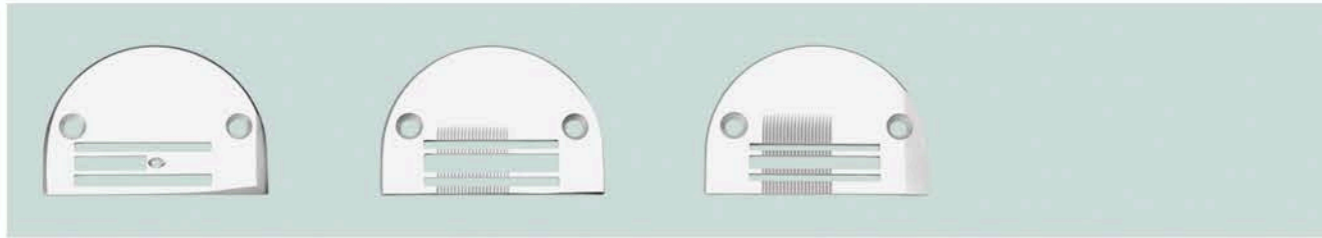

B1109-555-HOB

B1109-041-FOO

B1109-415-HOO

### FOR SIRUBA 银箭



E934 737-504M1-15

E783 737-505F1-03  
E784 737-505F1-04

E796 737-504M3-04  
E797 737-504M3-05

E800 737-504M2-04

E804 747-514M4-23  
E804A 747-512M8-23  
E805 747-514M4-24

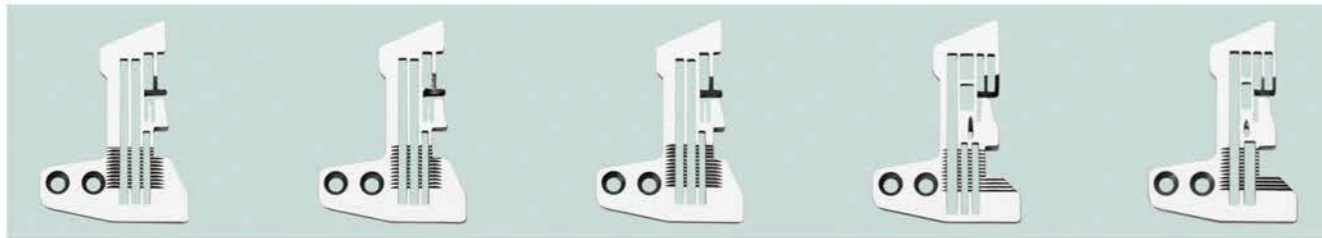

E809 747-514M2-24  
E809A 747-514M7-24

E919 747F-514M2-24  
E919A

E810 747-514M 2-25  
E810A 747-512M8-25  
E920 747-512M1-25  
E920A 747F-514M8  
E991 747F-514M2-26

E981  
E982 747-516M2-35  
E986 757-516M2-55

E834 757-516L1-24  
E838  
E839 757-5161-35

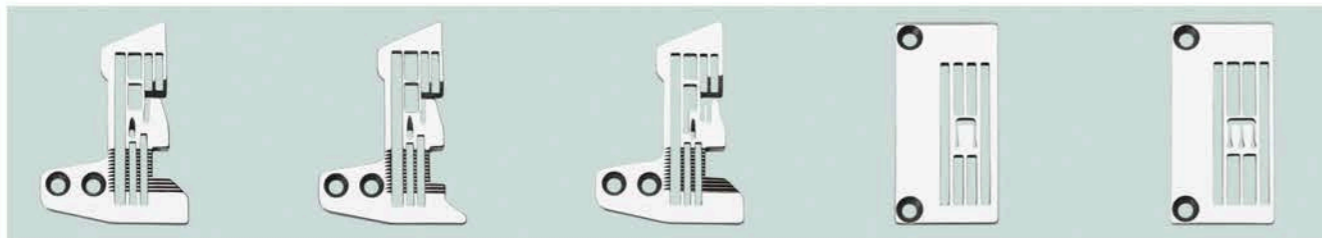

E868 757-516H2-56

E871

E989 767-516M2-324

E1524 F007E-W122(2x4.0)  
E1525 F007E-W122(2x4.8)

E1826 F007E-W122(3x5.6)  
E1827 F007E-W122(3x6.4)  
E1846 F007E-W162(3x5.6)  
E1847 F007E-W162(3x6.4)

### FOR SIRUBA 银箭

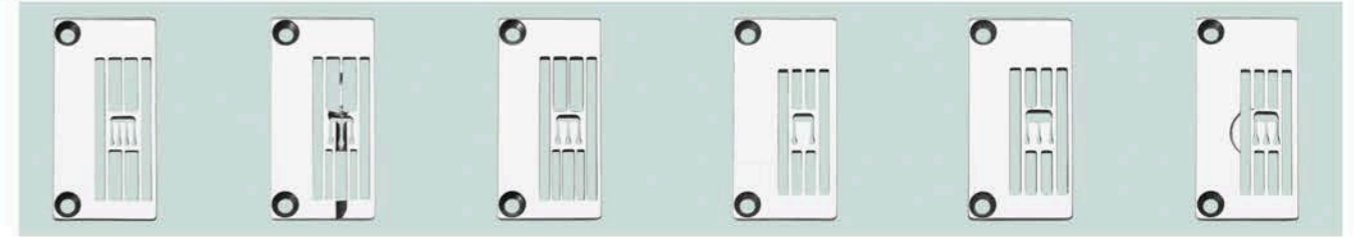

E1828  
F007E-W922/FW(4x6.0)

E2626P  
C007E/CE(3x5.6)  
E2627P  
C007E/CE(3x6.4)

E2826P  
C007E/CC(3x5.6)  
E2827P  
C007E/CC(3x6.4)

E3524P  
C007E/CH(2x4.0)  
E3525P  
C007E/CH(2x4.8)

E3827  
C007D(3x6.4)  
E3827P  
C007/CH(3x6.4)

E3846  
C007H-W162/UP(3x5.6)  
E3847  
C007H-W162/UP(3x6.4)

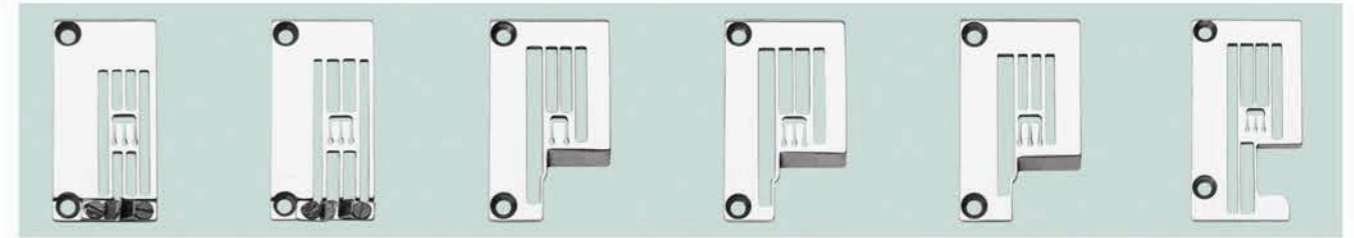

E3626  
C007(3x5.6)

E4826  
F007E/FDC(3x5.6)  
E4827  
F007E/FDC(3x6.4)

E3024  
F007E/FQ(2x4.0)  
E3025  
F007E/FQ(2x4.8)

E3326  
F007E/FQ(3x5.6)  
E3327  
F007E/FQ(3x6.4)

E4426P  
C007E/CQ(3x5.6)  
E4427P  
C007E/CQ(3x6.4)

E6024  
F007E-W522/FE(2x4.0)



E0226P  
C007E/CRL(3x5.6)  
E0227P  
C007E/CRL(3x6.4)

E0226Q  
C007E/UTP(3x5.6)  
E0227Q  
C007E/UTP(3x6.4)

E701

E702

E703



E704

E704D

E751

E711

E721

### FOR KANSAI SPECIAL 森本



14-724 V7002D

14-734 V7002D

14-744 V7002D 3/16"

14-754 V7002D 7/32"

14-764 V7002D 1/4"

14-760 DVK-1702BK(2x1/4")

14-854 W8103D(3x7/32")  
14-864 W8103D(3x1/4")

14-8180 WX-8800(3x7/32")

14-819 WX8703D 1/4"  
14-820 WX8703D 7/32"

### FOR KANSAI SPECIAL 森本

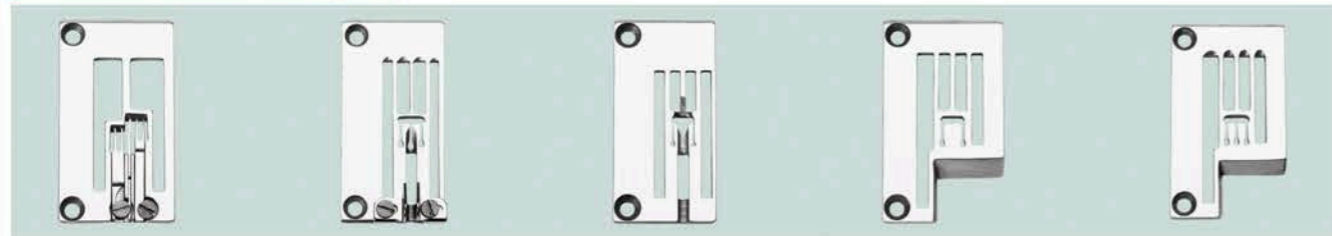

14-3010-O DPW-1302W	14-8010 W8103C(3x7/32") 14-8020 W8103C(3x1/4")	14-860 WX-8800(3x5.6) 14-861 WX-8800(3x5.6) 14-862 WX-8800(3x6.46)	14-726 DVK1702F 14-736 DVK1702F 14-746 DVK1702F(3x16") 14-756 DVK1702F(7/32") 14-766 DVK1702F(1/4")	14-856 DWK1803F(3x7/32") 14-866 DWK1803F(3x1/4")
---------------------	---	--	---	---

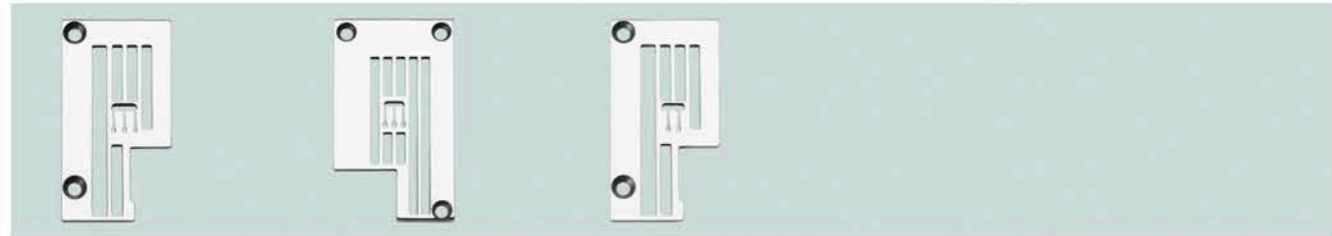

14-858 EWK1803EMK(3x7/32") 14/868 DWK1803EMK(3x1/4")	14-812 RX(3x5.6) 14-813 RX(3x6.4)	14-728 DWK1802EMK(2x3.2) 14-748 DWK1802EMK(2x4.8) 17-758 DWK1802EMK(2x5.6) 14-768 DWK1802EMK(2x6.4)
---	--------------------------------------	--

### FOR KINGTEX 宝狮

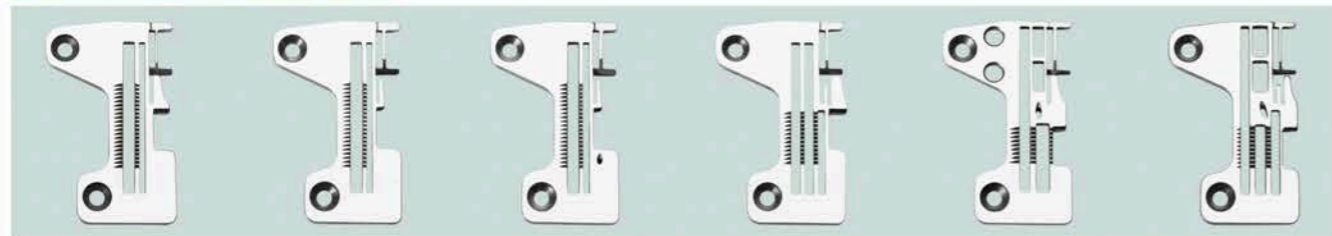

TP603032 SHF6003-032-M04	TP6B3022 SH-60B3	TP6B30221 SH-60B3	TP604A43 SH6004 TP604A53 SH6004	TP605C32 SH6005 TP605C52 SH-6005	TP606CA3 SH6006
--------------------------	------------------	-------------------	------------------------------------	-------------------------------------	-----------------

### FOR RIMOLDI 利满地



203219-0-11 627-00-1CD-31	203035-0-11 627-00-1CD-21	202504-0-10 202148-0-10 202507-0-10 203214-0-10 202590-0-10 203208-0-11	627-00-1CD-01-4.1 627-00-1CD-01-4.6 627-00-1CD-01-5 627-00-1CD-04 627-00-1CD-01-6 627-00-1CD-07	203549-0-10 627-00-2CD-32
------------------------------	------------------------------	--	--	------------------------------

### FOR SINGER 胜家

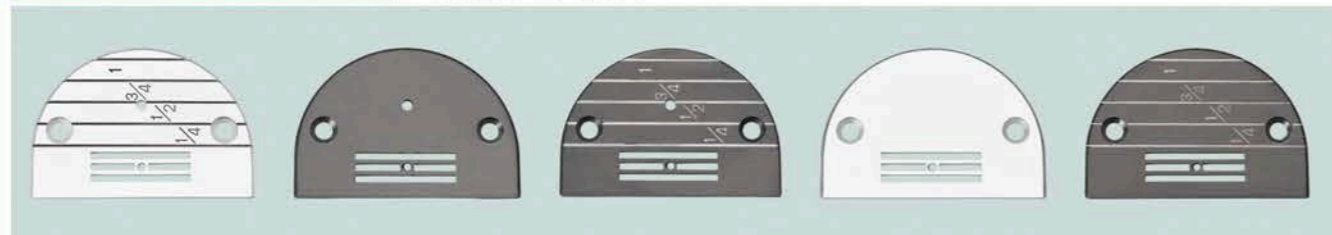

52032LGW	52032B	52032LGB	52033W	52033LGB
----------	--------	----------	--------	----------

### FOR SINGER 胜家



143169LGB	147150W	147150LGW	147150B	147150LGB
-----------	---------	-----------	---------	-----------



147158LGB	20160LGW	12482W	12482LGW	12482B
-----------	----------	--------	----------	--------

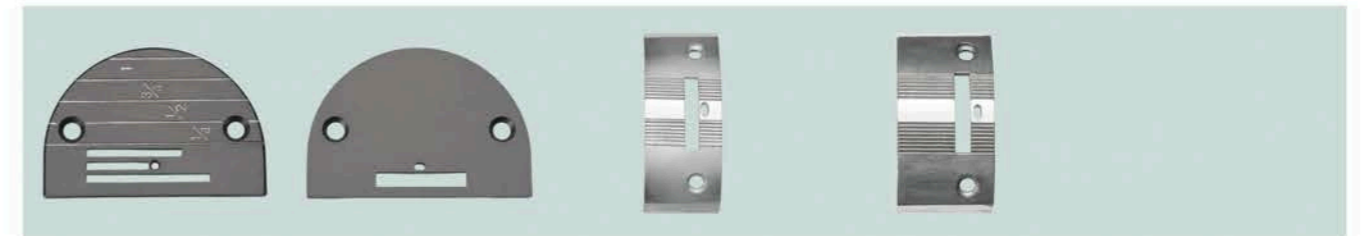

12482LGB	12438	16306	547895
----------	-------	-------	--------

### FOR FOLDER 喇叭系列



SPB-019	SPB-020	SPB-025	SPB-026	SPB-039
---------	---------	---------	---------	---------



SPB-041	SPB-042	K10	K10	K10
---------	---------	-----	-----	-----

# TOPDIS

NEEDLE PLATE 针板系列

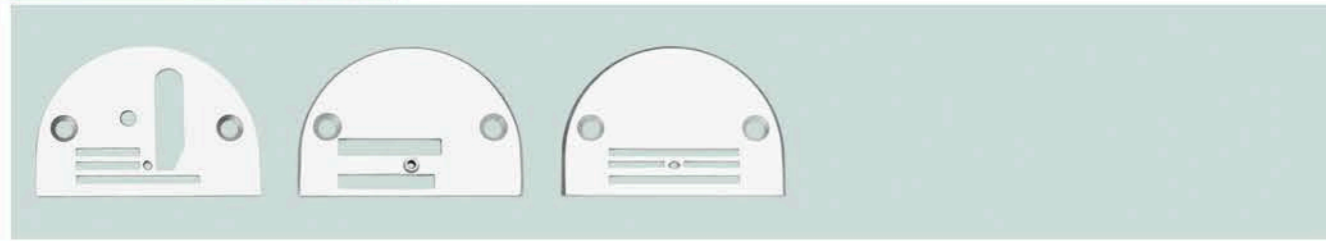

44-1      SP-007      SP-022

## TOYOTA 丰田系列



550443-452      550443-452      550445-452      785609009

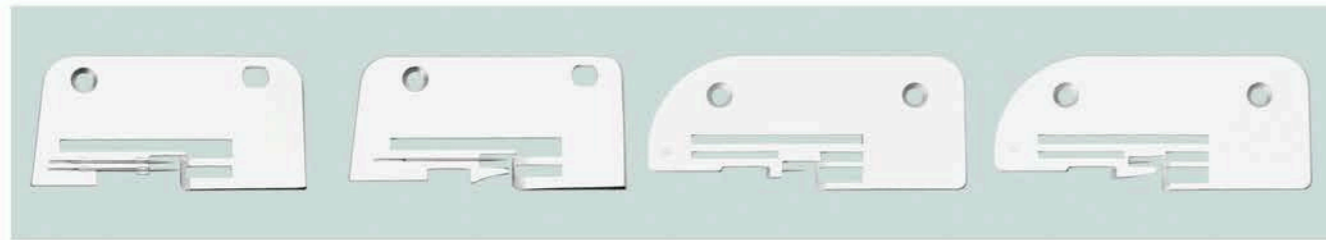

787601007      784626009      1250011-511      1250001-511

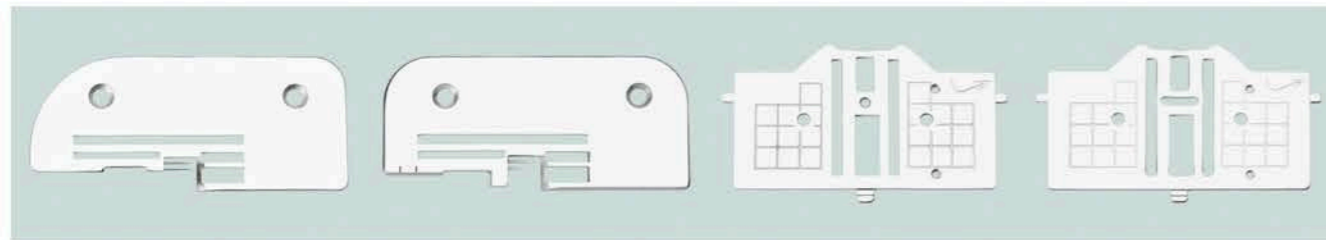

1250021-511      125215-001      671511-AGA10      671515-AGA10

## FOR H.M 家用系列

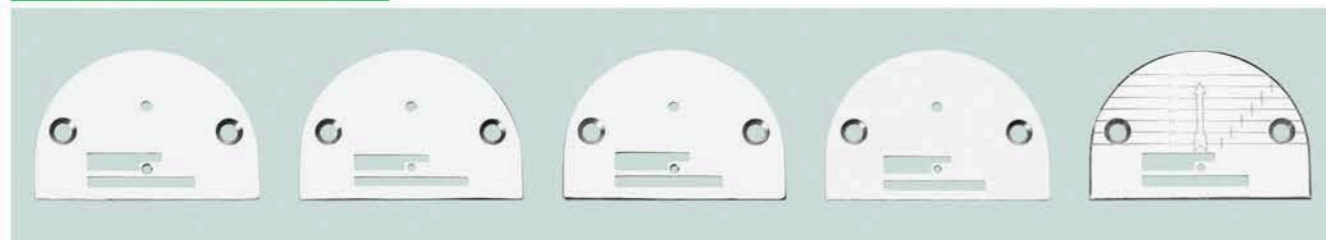

JA1-1      1149      15280      445805      HA1-5LG

# TOPDIS

NEEDLE PLATE 针板系列

## FOR H.M 家用系列

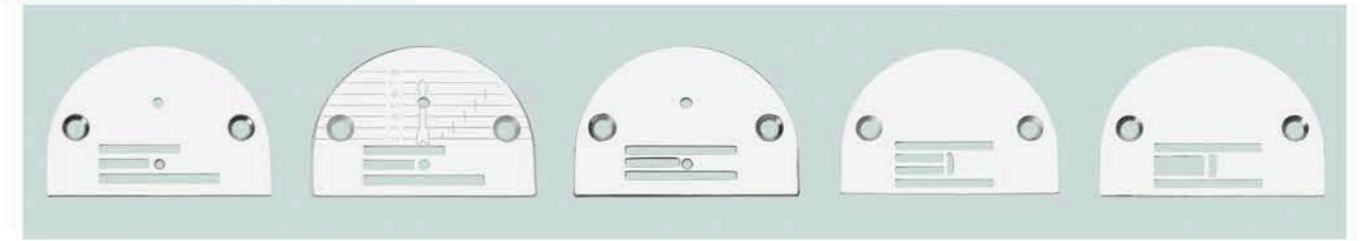

HA1-51-1      HA1-51-1LG      RRT      205/535      44443

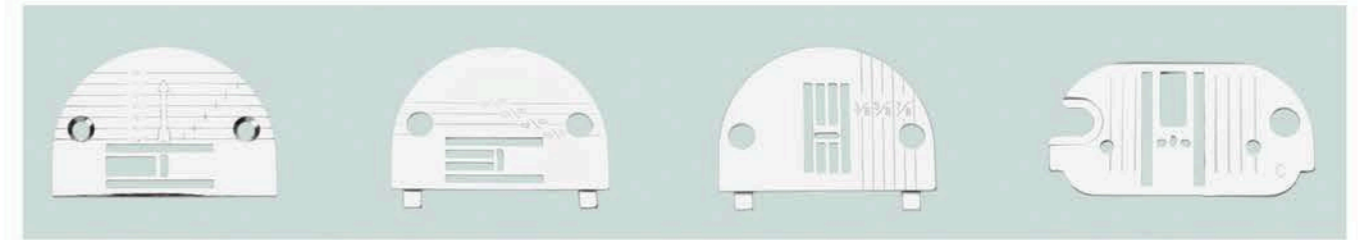

352105-840      NZ-5LG      NZ-13LG      313066

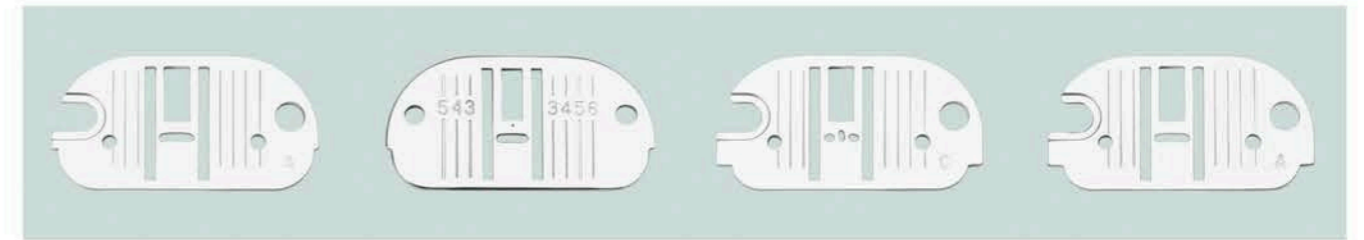

312777      174198      356713      356714

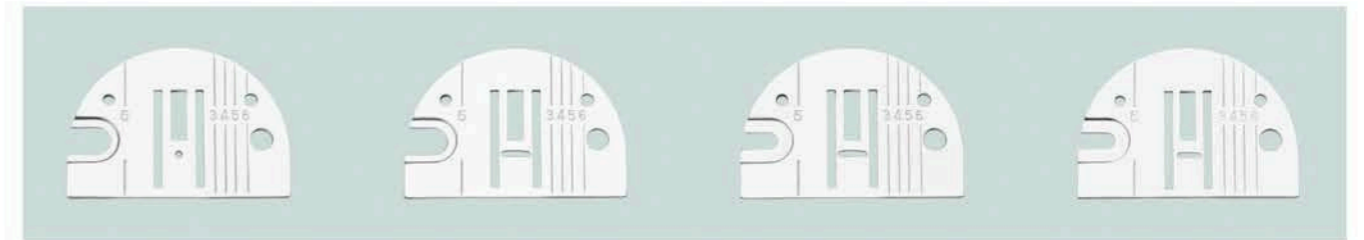

317399      317398      531663      445883



15147      446151





<p><b>CRN</b> CR1/32N (210R)  <b>CRE</b> CR1/16N (211N)                  CR1/32E (21R)                  CR1/16E (211)                  CR3/32E (211-1/2)                  CR1/8E (212)                  CR5/32E (212-1/2)                  CR3/16E (213)                  CR1/4E (214)                  CR5/16E (215R)                  CR3/8E (216R)                  CR1/2E (218R)</p> 	<p><b>CLN</b> CL1/32N (220L)  <b>CLE</b> CL1/16N (221N)                  CL1/32E (22R)                  CL1/16E (221)                  CL3/32E (221-1/2)                  CL1/8E (222)                  CL5/32E (222-1/2)                  CL3/16E (223)                  CL1/4E (224)                  CL5/16E (225R)                  CL3/8E (226R)                  CL1/2E (228R)</p> 	<p><b>CR15N</b> CR-10N-1.0mm                  CR-15N-1.5mm                  CR-10-1.0mm                  CR-15-1.5mm                  CR-20-2.0mm                  CR-25-2.5mm                  CR-30-3.0mm                  CR-40-4.0mm                  CR-50-5.0mm                  CR-60-6.0mm                  CR-65-6.5mm                  CR-70-7.0mm                  CR-80-8.0mm                  CR-90-9.0mm                  CR-100-10mm                  CR-130-13mm</p> 	<p><b>CL15N</b> CL-10N-1.0mm                  CL-15N-1.5mm                  CL-10-1.0mm                  CL-15-1.5mm                  CL-20-2.0mm                  CL-25-2.5mm                  CL-30-3.0mm                  CL-40-4.0mm                  CL-50-5.0mm                  CL-60-6.0mm                  CL-65-6.5mm                  CL-70-7.0mm                  CL-80-8.0mm                  CL-90-9.0mm                  CL-100-10mm                  CL-130-13mm</p> 
--	--	--	--

<p><b>CR</b> CR1/32                  CR1/16                  CR3/32                  CR1/8                  CR5/32                  CR3/16                  CR1/4                  CR5/16                  CR3/8                  CR1/2</p> 	<p><b>CL</b> CL1/32                  CL1/16                  CL3/32                  CL1/8                  CL5/32                  CL3/16                  CL1/4                  CL5/16                  CL3/8                  CL1/2</p> 	<p><b>211-15</b> 21-13 (1/32x3/16)                  21-13 (1/16x3/16)                  21-14 (1/32x1/4)                  21-14 (1/16x1/4)                  21-15 (1/32x5/16)                  21-15 (1/16x5/16)                  21-16 (1/32x3/8)                  21-16 (1/16x3/8)                  21-18 (1/32x1/2)                  21-18 (1/16x1/2)</p> 	<p><b>S532</b>                  (P312SB)</p> 
---	---	---	--

<p><b>S537</b> S537-1/8 (A227-1/8)                  S537-3/16 (A227-3/16)                  S537-1/4 (A227-1/4)                  S537-5-16 (A227-5-16)                  S537-3/8 (A227-3/8)                  S537-1/2 (A227-1/2)</p> 	<p><b>127233</b>                  (P127)</p> 	<p><b>12463HR</b> 12463HR-1/32 (P810)                  12463HR-1/16 (P811)                  12463HR-3/32 (P8115)                  12463HR-1/8 (P812)                  12463HR-3/16 (P813)                  12463HR-1/4 (P814)                  12463HR-5/16 (P815)                  12463HR-3/8 (P816)                  12463HR-1/2 (P818)</p> 	<p><b>12463HL</b> 12463HL-1/32 (P810L)                  12463HL-1/16 (P811L)                  12463HL-3/32 (P8115L)                  12463HL-1/8 (P812L)                  12463HL-3/16 (P813L)                  12463HL-1/4 (P814L)                  12463HL-5/16 (P815L)                  12463HL-3/8 (P816L)                  12463HL-1/2 (P818L)</p> 
---	--	--	---

<p><b>CD</b> CDN-00 (230)                  CD-00 (23)                  CD-10-1.0mm                  CD-15-1.5mm                  CD-20-2.0mm                  CDN-1/32 (D23N)                  CD-1/32 (D23)                  CDN-1/16 (D231N)                  CD-1/16 (D231)                  CD-1/8 (D232)                  CD-3/16 (D233)                  CD-1/4 (D234)</p> 	<p><b>601</b> 601 (CB-3/4) 3.0mm                  602 (CB-1) 4.5mm                  603 (CB-1-1/8) 5.5mm                  603 (CB-1-1/4) 7.0mm</p> 	<p><b>CRK</b> CR1/32K (CR08K)                  CR1/16K (CR15K)                  CR3/32K (CR25K)                  CR1/8K (CR30K)                  CR5/32K (CR40K)                  CR3/16K (CR50K)                  CR1/4K (CR65K)                  CR5/16K (CR80K)                  CR3/8K (CR100K)                  CR1/2K (CR130K)</p> 	<p><b>CLK</b> CL1/32K (CL08K)                  CL1/16K (CL15K)                  CL3/32K (CL25K)                  CL1/8K (CL30K)                  CL5/32K (CL40K)                  CL3/16K (CL50K)                  CL1/4K (CL65K)                  CL5/16K (CL80K)                  CL3/8K (CL100K)                  CL1/2K (CL130K)</p> 
--	--	--	--

<p><b>S801</b> (SP-61)  <b>S802</b> (SP-62)  <b>S803</b> (SP-63)  <b>S804</b> (SP-64)</p> 	<p><b>CRNS</b> CR1/32NS                  CR1/16NS</p> 	<p><b>CLNS</b> CL1/32NS                  CL1/16NS</p> 	<p><b>S10A</b> S10A-1/8 (P318A)                  S10A-3/16 (P3316A)                  S10A-1/4 (P314A)                  S10A-5/16 (P3516A)                  S10A-3/8 (P338A)                  S10A-7/16 (P3716A)                  S10A-1/2 (P312A)                  S10A-9/16 (P3916A)                  S10A-5/8 (P358A)                  S10A-3/4 (P334A)                  S10A-7/8 (P378A)                  S10A-1 (P325A)                  S10A-1-1/8 (P3118A)                  S10A-1-1/4 (P3114A)                  S10A-1-3/8 (P3138A)                  S10A-1-1/2 (P3112A)</p> 
---	---	---	---

<p><b>S10K</b> S10K-1/8                  S10K-3/16                  S10K-1/4                  S10K-5/16                  S10K-3/8                  S10K-7/16                  S10K-1/2                  S10K-9/16                  S10K-5/8                  S10K-3/4                  S10K-7/8                  S10K-1"</p> 	<p><b>12142C</b> 12142C-5/8 (A10-01-5/8)                  12142C-3/4 (A10-01-3/4)                  12142C-7/8 (A10-01-7/8)                  12142C-1 (A10-01-1)                  12142C-1 1/8 (A10-01-1 1/8)                  12142C-1 1/4 (A10-01-1 1/4)                  12142C-1 1/2 (A10-01-1 1/2)                  12142C-1 3/4 (A10-01-1 3/4)</p> 	<p><b>2314-24</b> 2314-24 (1/32X1/4)                  231-14-24 (1/16X1/4)                  23-15-25 (1/32X5/16)                  231-15-25 (1/16X5/16)                  231-15-25 (1/16X5/16)</p> 	<p><b>S530S</b></p> 
--	---	--	---

### P50W

(A)  
(B)



### 36069HL

36069HL-1/16 (P69LH-1/16)  
36069HL-1/8 (P69LH-1/8)  
36069HL-3/16 (P69LH-3/16)  
36069HL-1/4 (P69LH-1/4)  
36069HL-5/16 (P69LH-5/16)



### 36069DG

36069DG-1/8 (P69D-1/8)  
36069DG-3/16 (P69D-3/16)  
36069DG-1/4 (P69D-1/4)



### 36069R

36069R-1/16 (P69R-1/16)  
36069R-1/8 (P69R-1/8)  
36069R-3/16 (P69R-3/16)  
36069R-1/4 (P69R-1/4)  
36069R-3/8 (P69R-3/8)  
36069R-1/2 (P69R-1/2)



### 36069L

36069L-1/16 (P69L-1/16)  
36069L-1/8 (P69L-1/8)  
36069L-3/16 (P69L-3/16)  
36069L-1/4 (P69L-1/4)  
36069L-3/8 (P69L-3/8)  
36069L-1/2 (P69L-1/2)



### 36069HR

36069HR-1/16 (P69RH-1/16)  
36069HR-1/8 (P69RH-1/8)  
36069HR-3/16 (P69RH-3/16)  
36069HR-1/4 (P69RH-1/4)  
36069HR-5/16 (P69RH-5/16)



### P31C/12435R

12435R-1/8 (P31C-1/8)  
12435R-3/16 (P31C-3/16)  
12435R-1/4 (P31C-1/4)



### P50

120828 (P50)  
120828N (P50N)  
120828H (P50H)  
120828M (P50M)



### S521 3/16~2 (P723)



**LOT NO:** 160344 (LOT NO: 1-1/16)  
(LOT NO: 1 1/2-5/64)  
120938 (LOT NO: 2-3/32)  
120803 (LOT NO: 2 1/2-1/8)  
120804 (LOT NO: 3-5/32)  
120805 (LOT NO: 4-3/16)  
120940 (LOT NO: 5-7/32)  
120806 (LOT NO: 6-1/4)  
120807 (LOT NO: 7 1/2-5/16)



### NR-31S



### NL-31S

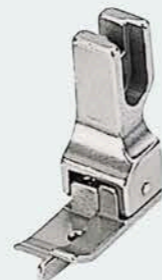

### S570

S5701/8 (1/8x1/32)  
S5703/16 (3/16x1/32)  
S5701/4 (1/4x1/32)  
S5705/16 (5/16x1/32)  
S5703/8 (3/8x1/32)  
S5707/16 (7/16x1/32)  
S5701/2 (1/2x1/32)  
S570R (1/8x1/16)  
(3/16x1/16)  
(1/4x1/16)  
(5/16x1/16)  
(3/8x1/16)  
(7/16x1/16)  
(1/2x1/16)



### FOR112W, 212W

224127 1/32" 1/16"  
224158 3/32" 1/8"  
5/32" 3/16"  
223759 7/32" 1/4"  
9/32" 5/16" 11/32"  
3/8" 13/32" 7/16"  
15/32" 12" 17/32"  
9/16" 19/32" 5/8"  
11/16" 34" 13/16"  
7/8" 15/16" 1"  
1 1/16" 1 1/8" 1 1/16"  
1 1/4" 1 1/16" 1 1/8" 1 1/2"



### S570L (P112HL)

S570L 1/8X1/16  
S570L 3/16X1/16  
S570L 1/4X1/16  
S570L 5/16X1/16  
S570L 3/8X1/16  
S570L 1/2X1/16  
S570L 5/8X1/16  
S570L 3/4X1/16  
S570L 7/8X1/16  
S570L 1"X1/16



### S570DG (P112HD)

S570DG 3/16X1/32  
S570DG 1/4X1/32  
S570DG 5/16X1/32  
S570DG 3/8X1/32  
S570DG 7/16X1/32  
S570DG 1/2X1/32  
S570DG 9/16X1/32  
S570DG 5/8X1/32  
S570DG 11/16X1/32  
S570DG 3/4X1/32  
S570DG 13/16X1/32  
S570DG 7/8X1/32  
S570DG 15/16X1/32



S570DG 1"X1/32  
S570DG 1-1/16X1/32  
S570DG 1-1/8X1/32  
S570DG 1-3/16X1/32  
S570DG 1-1/4X1/32  
S570DG 1-5/16X1/32  
S570DG 1-3/8X1/32  
S570DG 1-1/2X1/32  
S570DG 1-9/16X1/32  
S570DG 1-5/8X1/32  
S570DG 1-3/4X1/32  
S570DG 1-7/8X1/32  
S570DG 2"X1/32

### 36465

36465-1/32 (P10)  
36465-1/16 (P11)  
36465-3/32 (P115)  
36465-1/8 (P12)  
36465-3/16 (P13)  
36465-1/4 (P14)  
36465-5/16 (P15)  
36465-3/8 (P16)  
36465-1/2 (P18)



### P15

P11  
P12  
P13  
P14  
P15  
P16  
P18



### 543939



### S950 (P950)



### S952 (P952)



### P803 3/16~7/8



### SP-18R(L)

1/32 1/16  
1/8 3/16  
1/4 5/32  
5/16 3/8



### 40322SH (P363)



### P5 (P5R)



### S518NS



### S518N



### S518



### S518S











**S380靠边靴** Over lock  
外脚 内脚  
outside inside

**JK-247单边靴** Sing side  
外脚 内脚  
outside inside

**S380埋袋坑靴 (B)** 3.0#  
Compound feeding (B) 4.0#  
外脚 内脚 5.0#  
outside inside

**240148 240149**

**S009坑靴底带高齿**  
外脚 内脚  
outside inside



**JK-241**  
外脚 内脚  
outside inside

**8B (无齿)** (no tooth)  
外脚 内脚  
outside inside

**JK-241**  
外脚 内脚  
outside inside

**CW-8B**  
外脚 内脚  
outside inside

**8B双针靴** Double needle  
8BP 8BF



**CW-8B (左) (右)** (left) (right)

**63900** 1/4  
5/8  
3/4  
1"

**兄弟花样机** 2.5mm  
Brother pattern machine

**814 32#**

**814 16#**

**300GA** 3/8x3/8x3/8



**1702**

**1900** Ø2.0  
Ø2.5

**B2529-372-000 JUKI 373**

**1900 6x27N**



# TOPDIS

## PRESSER FOOT 压脚系列



757



飞马五线厚料靴  
PEGASUS 5 thread (heavy)  
银箭五线厚通用  
SIRUBA 5 thread (heavy)



208506S



飞马三线六线厚料压脚  
PEGASUS 3 & 6 thread (heavy)



飞马五线薄料 (208504)  
PEGASUS 5 thread (light)



P504



飞马五线薄料靴  
PEGASUS 5 thread (light)  
银箭五线通用  
SIRUBA 5 thread (light)



208649



757



老兄弟四线压脚  
BROTHER 4 thread (old type)



老兄弟五线压脚 (142250)  
BROTHER 5 thread (old type)



老兄弟五线压脚  
BROTHER 5 thread (old type)



4.0



5.6



5.6



6.4



529ER 4.0



529ERE 6.4



529ER 3.2



529ER 4.8



凹车轮子靴 3/16  
Interlock presser foot with wheels



凹车轮子靴 7/32  
Interlock presser foot with wheels



凹平轮子靴 4.0  
Interlock presser foot with wheels



凹车轮子靴 1/4  
Interlock presser foot with wheels

# TOPDIS

## PRESSER FOOT 压脚系列



5.6圆头靴  
Round



P2408



P0216



5.6左刀压脚  
Left align



5.6右刀压脚  
Right align



5.6右刀靴  
Right align



5.6右窄  
Right cutter narrow gap



5.6死刀压脚  
Fixed



5.6



4.0刀靴  
With even device



3.2刀靴  
With even device



6.4刀靴  
With even device



4.8刀靴  
With even device



04041N 5.6



4.8三针刀靴  
3 needle with even device



5.6星菱  
SHINGLING



P1406



5.6单边定位  
Left align



92155



528K左右磅位靴  
Left and right align



212WC-9 1", 1-1/8, 1-1/4, 1-3/8  
1-1/2, 1-3/4, 1-7/8, 2"



T-107 T-107B



T-S518 YKK



TRF1-R



5mm 8mm 10mm  
12mm 15mm 20mm  
SR-DB-R SR-DB-RB



T8115SR T815SRB



T812SR T812SRB



TRF1 TRF1B



T811SR T811SRB



T350 T350B



T363 T363B

# TOPDIS

## PRESSER FOOT 压脚系列



T36LN T36LNB T36N T36NB T813 T813B T814 T814B T652 12mm T652B 12mm



T652 9mm T652B 9mm T652 6mm T652B 6mm T36L T36LN T351 T351B T351 T351B 11mm



T35W 12.5mm T35WB MT1 MT2 MT-260 3/16, 1/4, 5/16, 3/8, 1/2, 3/4, 1# MT-260 1/8 MT-1/8B MT-A MT-AB 12.5mm



MT1 MT2 T35CW 11mm, 12.5mm, 15mm T69R T69RB T69L T69LB 1/8, 1/4, 3/16 T-S518 T-S518B MT-18 MT-18B



MF23-7 MF23-7B MF23-8 MF23-8B T350D T350DB T350L T350LB T811 T811B



T812 T812B T815 T815B TCL1/32, 1/16, 1/8, 1/4, 1/2 TCL1/32E, 1/16E, 1/8E, 1/4E TCR1/32, 1/16, 1/8, 1/4, 1/2 TCR1/32E, 1/16E, 1/8E, 1/4E

# TOPDIS

## FEED DOG 牙齿系列



12481(9T-21T) 149057 272153 B1609-2010 26095



2110225 213 309 1490457特细牙 Ultra-fine 12481特细牙 Ultra-fine



SA2345 147143 111898 S02744 149057斜牙 Oblique



319-000 211105-223D 12481斜牙 Oblique 1613-155W SS2-000



26208 144500 S02744 149006 149159



61405Y 防皱牙 Crease-resist 46398 1613-555 59816



275010 275005 12451R 149057R 12481TR

# TOPDIS

## FEED DOG 牙齿系列



# TOPDIS

## FEED DOG 牙齿系列



# TOPDIS

## FEED DOG 牙齿系列

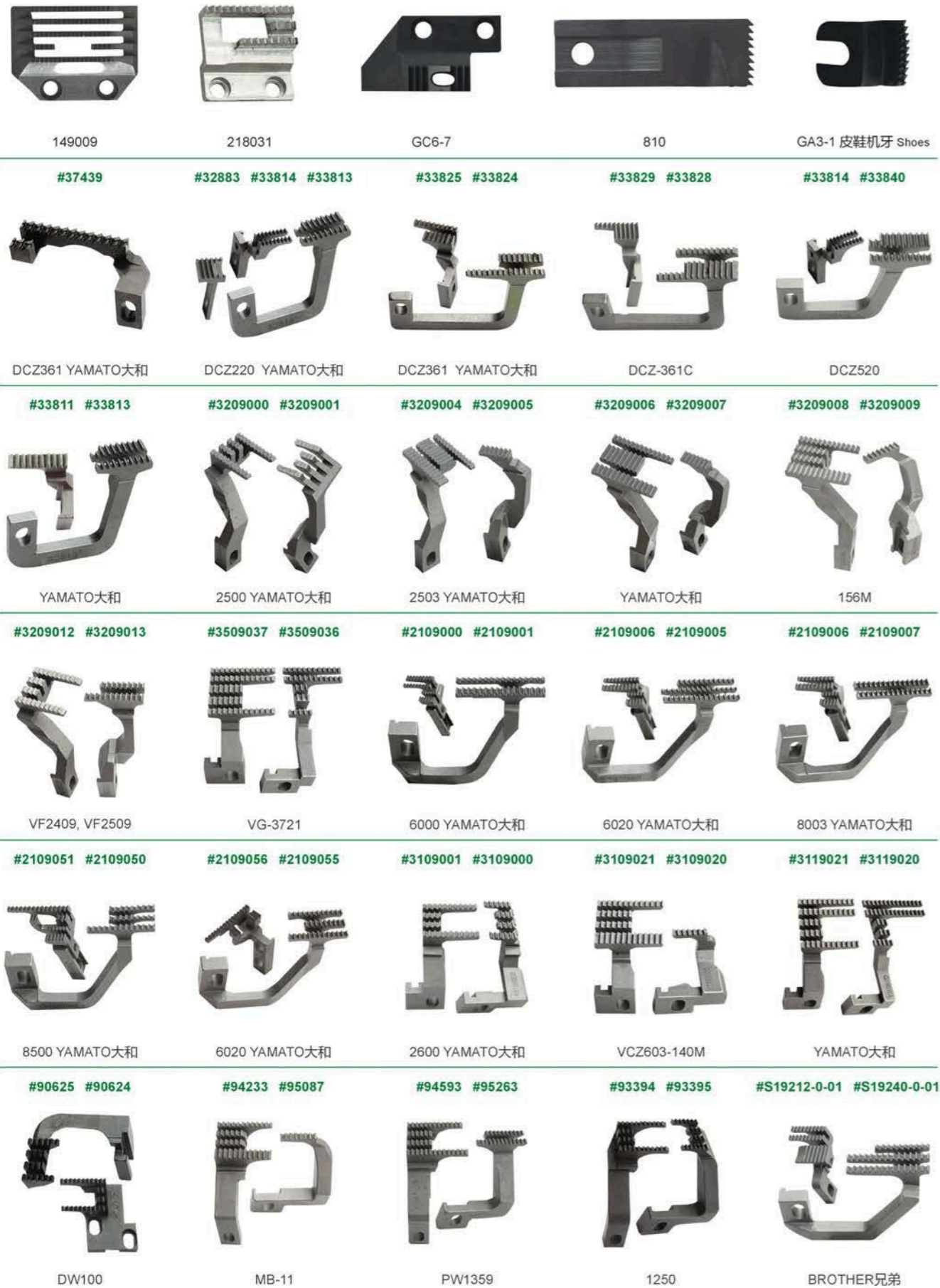

# TOPDIS

## FEED DOG 牙齿系列



#227315-16F #277302-16F #277323-16F #277325-16F #277303-16F #277305-16F #277327-16F #277329-16F #277300-16F #277302-16F



5024-32 PEGASUS 飞马 3216-02 PEGASUS 飞马 5204 PEGASUS 飞马 3216 PEGASUS 飞马 5204-01 PEGASUS 飞马

#208063 #208215 #208064 #208017 #208065 #208218 #202634A #201097C #201094B #202854A



L32-70 PEGASUS 飞马 L32-86 PEGASUS 飞马 L32-36 PEGASUS 飞马 5301 PEGASUS 飞马 5301 PEGASUS 飞马

#201094B #201097C #201094B #202854A #208066 #208219 #118-82206 #118-85100



2504 JUKI 重机

#118-82800 #118-85209 #118-84004 #121-73308 #12476107 #12478103 #118-82800 #121-72805 #12476800 #12479101



2516 JUKI 重机 3916 JUKI 重机 3314 JUKI 重机 3916 JUKI 重机 JUKI 重机

#118-83006 #118-85407 #115-97101 #1657-814-BOE #257214-16F #257260-16F #257215-16F #257261-16F #257216-16F #257262-16F



2516 JUKI 重机 2514 JUKI 重机 W561 PEGASUS 飞马 W562-02 PEGASUS 飞马 W562-02 PEGASUS 飞马

#1656-804-000 #1657-804-00C #12476305 #12478301 #12476008 #12478004 #12476206 #12478905 #12476404 #12478509



804 JUKI 重机 3305 JUKI 重机 3304 JUKI 重机 3316 JUKI 重机 3316 JUKI 重机

#12476206 #12478400 #118-84004 #121-73308 #118-82107 #1657-804-00T #146744-0-01 #146749-0-01 #164568-0-01 #146573-0-01



3316 JUKI 重机 3916 JUKI 重机 2504 JUKI 重机 BROTHER 兄弟 BROTHER 兄弟

#S19210-0-01 #S25574-0-01 #119-49807 #119-49906 #118-80404 #118-86504 #12476701 #12478806 #12476206 #12478202



BROTHER 兄弟 3914 JUKI 重机 2514 JUKI 重机 3304 JUKI 重机 3343 JUKI 重机

#H4259 #D4207 #H4206 #D4258 #H3159 #D2107 #H1259 #D1207 #H442 #D290



SIRUBA 银箭 SIRUBA 银箭 SIRUBA 银箭 SIRUBA 银箭 SIRUBA 银箭

#H445 #D575 #H501 #D582 #H497 #D581 #H500 #D489



SIRUBA 银箭 SIRUBA 银箭 SIRUBA 银箭 SIRUBA 银箭

# UNIQUE

## FOLDER 拉筒系列



高要求，高品质，展现质的美感.....  
High requirement, high quality,  
show qualitative beauty.....

# FOLDER

# UNIQUE

FOLDER 拉筒系列

**FD-101**  
S123A 单折可调插筒  
RIGHT ANGLE BINDER



**作用：**拉针织T恤领、袖等  
**用机：**2或3针车  
**Purpose:**  
Binding of knitwear collar  
and sleeve  
**Machine:**  
2 or 3 needle cover stitch  
machine

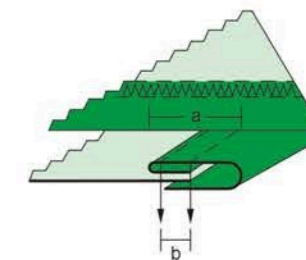

出口 a Finished Size	寸 Inches	1/4	5/16	3/8	1/2	5/8	3/4	7/8	1
入口 Tape Size	寸 Inches	3/4	15/16	1-1/8	1-3/8	1-5/8	1-7/8	2-1/8	2-3/8

**FD-102**  
S123B 双折可调插筒  
RIGHT ANGLE BINDER



**作用：**拉针织T恤领、袖等  
**用机：**2或3针车  
**Purpose:**  
Binding of knitwear collar  
and sleeve  
**Machine:**  
2 or 3 needle cover stitch  
machine

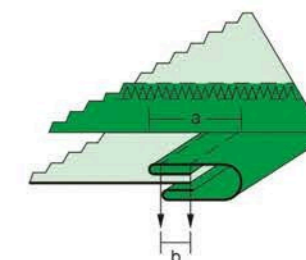

出口 a Finished Size	寸 Inches	1/4	5/16	3/8	1/2	5/8	3/4	7/8	1
入口 Tape Size	寸 Inches	1	1-1/4	1-1/2	1-3/4	2	2-1/4	2-1/2	2-3/4

**FD-103**  
S124A 平座单折可调筒  
RIGHT ANGLE BINDER



**作用：**拉针织T恤领、袖等  
**用机：**2或3针车  
**Purpose:**  
Binding of knitwear collar  
and sleeve  
**Machine:**  
2 or 3 needle cover stitch  
machine

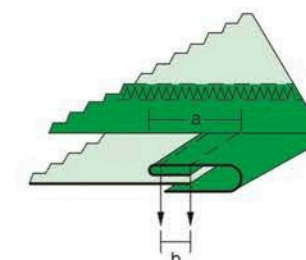

出口 a Finished Size	寸 Inches	1/4	5/16	3/8	1/2	5/8	3/4	7/8	1
入口 Tape Size	寸 Inches	3/4	15/16	1-1/8	1-3/8	1-5/8	1-7/8	2-1/8	2-3/8

**FD-104**  
S124B 平座双折可调筒  
RIGHT ANGLE BINDER



**作用：**拉针织T恤领、袖等  
**用机：**2或3针车  
**Purpose:**  
Binding of knitwear collar  
and sleeve  
**Machine:**  
2 or 3 needle cover stitch  
machine

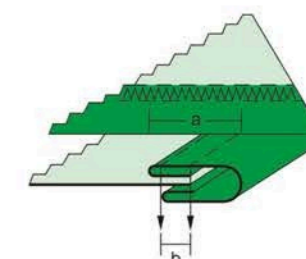

出口 a Finished Size	寸 Inches	1/4	5/16	3/8	1/2	5/8	3/4	7/8	1
入口 Tape Size	寸 Inches	1	1-1/4	1-1/2	1-3/4	2	2-1/4	2-1/2	2-3/4

**FD-105** 单折子母可调插筒  
RIGHT ANGLE BINDER WITH PIPING-LOOSE BOTTM  
AT17A



**作用:** 拉针织T恤领、袖等  
**用机:** 2或3针车  
**Purpose:** Binding of knitwear collar and sleeve  
**Machine:** 2 or 3 needle cover stitch machine

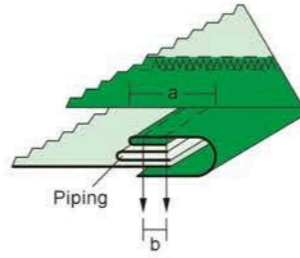

Piping	出	3/8	7/16
	Out		
寸	入	3/4	7/8
Inches	In		

出口 a	寸	1/4	5/16	3/8	1/2	5/8	3/4	7/8	1
Finished Size	Inches								
入口	寸	3/4	15/16	1-1/8	1-3/8	1-5/8	1-7/8	2-1/8	2-3/8
Tape Size	Inches								

**FD-106** 双折子母可调插筒  
RIGHT ANGLE BINDER WITH PIPING-LOOSE BOTTM



**作用:** 拉针织T恤领、袖等  
**用机:** 2或3针车  
**Purpose:** Binding of knitwear collar and sleeve  
**Machine:** 2 or 3 needle cover stitch machine

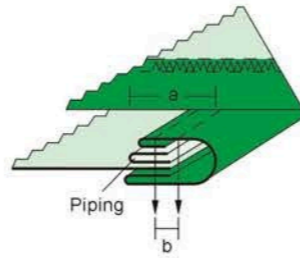

Piping	出	3/8	7/16
	Out		
寸	入	3/4	7/8
Inches	In		

出口 a	寸	1/4	5/16	3/8	1/2	5/8	3/4	7/8	1
Finished Size	Inches								
入口	寸	1	1-1/4	1-1/2	1-3/4	2	2-1/4	2-1/2	2-3/4
Tape Size	Inches								

**FD-107** 平座单折子母可调筒  
RIGHT ANGLE BINDER WITH PIPING-LOOSE BOTTM



**作用:** 拉针织T恤领、袖等连捆条  
**用机:** 2或3针车  
**Purpose:** Binding of knitwear collar and sleeve with piping  
**Machine:** 2 or 3 needle cover stitch machine

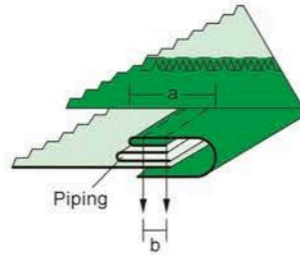

Piping	出	7/8	7/16
	Out		
寸	入	3/4	3/8
Inches	In		

出口 a	寸	1/4	5/16	3/8	1/2	5/8	3/4	7/8	1
Finished Size	Inches								
入口	寸	3/4	15/16	1-1/8	1-3/8	1-5/8	1-7/8	2-1/8	2-3/8
Tape Size	Inches								

**FD-108** 平座双折子母可调筒  
RIGHT ANGLE BINDER WITH PIPING-LOOSE BOTTM



**作用:** 拉针织T恤领、袖等连捆条  
**用机:** 2或3针车  
**Purpose:** Binding of knitwear collar and sleeve with piping  
**Machine:** 2 or 3 needle cover stitch machine

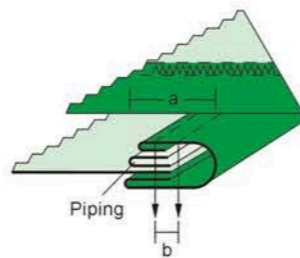

Piping	出	7/8	7/16
	Out		
寸	入	3/4	3/8
Inches	In		

出口 a	寸	1/4	5/16	3/8	1/2	5/8	3/4	7/8	1
Finished Size	Inches								
入口	寸	1	1-1/4	1-1/2	1-3/4	2	2-1/4	2-1/2	2-3/4
Tape Size	Inches								

**FD-109** 活动双折包边筒  
ADJUSTABLE DOUBLE FOLD RIGHT ANGLE  
K10



**作用:** 捆条布边  
**用机:** 单针平车  
**Purpose:** Binding of curve edge  
**Machine:** 1 needle lockstich machine

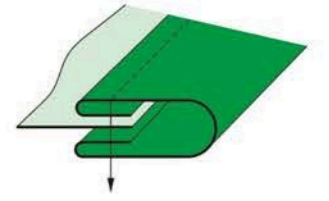

出口 a	Inches	5/32	11/64	13/64	15/64	1/4	9/32	5/16	11/32	23/64	25/64	7/16	15/32	1/2	19/32
Finished Size	mm	4	4.5	5	6	6.5	7	8	8.5	9	10	11	12	13	15
入口	Inches	45/64	25/32	7/8	15/16	1	1-1/8	1-3/16	1-1/4	1-11/32	1-11/32	1-9/16	1-21/32	1-3/4	2
Tape Size	mm	18	20	22	24	26	28	30	32	34	36	40	42	45	50

**FD-110** 活动单折包边筒  
ADJUSTABLE SINGLE FOLD RIGHT ANGLE



**作用:** 捆条布边  
**用机:** 单针平车  
**Purpose:** Binding of curve edge  
**Machine:** 1 needle lockstich machine

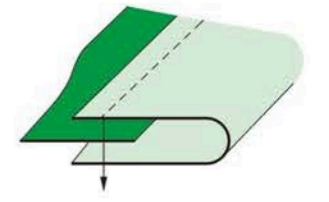

出口 a	寸	6	7	7.5	8	9	10	11	12	13
Finished Size	Inches									
入口	寸	12	14	15	16	18	20	22	24	26
Tape Size	Inches									

**FD-111** 绷缝车直角包边筒  
RIGHT ANGLE BINDER FOR COVERING STITCH MACHINE

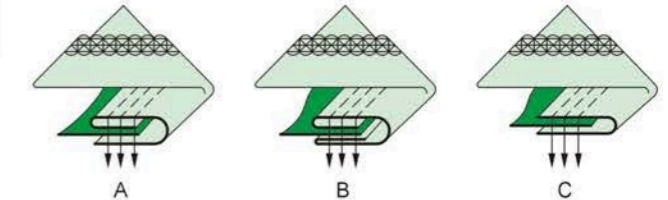

**Purpose:** Binding of knit wear collar and sleeve  
**Machine:** 2 or 3 needle cover stitch machine

出口	寸	1/4	5/16	3/8	1/2	5/8	3/4	7/8	1	1-1/8	1-1/4	1-3/8	1-1/2
Finished Size	Inches												
入口	寸	3/4	15/16	1-1/8	1-3/8	1-5/8	1-7/8	2-1/8	2-3/8	2-5/8	2-7/8	3-1/8	3-3/8
Tape Size	Inches												

**FD-114** 恤衫明筒  
TOP CENTER PLAIT FOLDER  
AT45



**作用:** 男女衫前胸明筒一有朴  
**用机:** 2或4针车  
**Purpose:** Top center plait of shirt and blouse-with lining  
**Machine:** 2 or 4 needle machine

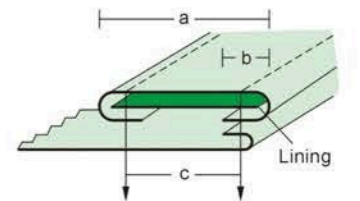

尺寸	a	7/8	1	1-1/8	1-3/16	1-1/4	1-3/8	1-1/2	1-5/8	1-3/4
Size	b	3/8			1/2					
寸	c	5/8-3/4	5/8-7/8	5/8-1	11/16-1-1/16	3/4-1-1/8	7/8-1-1/4	1-1-3/8	1-1/8-1-1/2	1-1/4-1-5/8
Inches	入口IN	1-5/8	1-3/4	1-7/8	2-3/16	2-1/4	2-3/8	2-1/2	2-5/8	2-3/4

**FD-115** 恤衫明筒  
TOP CENTER PLAIT FOLDER



**作用:** 男女衫前胸明筒  
**用机:** 2或4针车  
**Purpose:** Center plait of shirt and blouse  
**Machine:** 2 or 4 needle placket machine

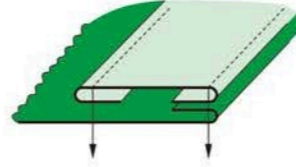

出口 Finished Size	寸 Inches	3/4	7/8	1	1-1/8	1-1/4	1-3/8	1-1/2	1-5/8	1-3/4
---------------------	-------------	-----	-----	---	-------	-------	-------	-------	-------	-------

**FD-116** 上下布裤头筒  
TWO PIECES WAIST BAND FOLDER  
AT63

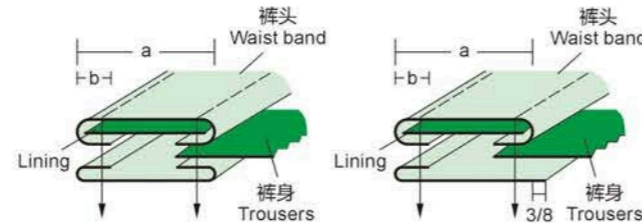

**作用:** 缝折裤头  
**用机:** 2或4针裤头车  
**Purpose:** Attach waist band  
**Machine:** 2 or 4 needle waist band machine

尺寸 Size	a	1	1-1/8	1-3/8	1-1/4	1-3/8	1-1/2	1-5/8	1-3/4	1-7/8	2
寸 Inches	b	3/8	1/2								
入口 IN	1-3/4	2-1/8	2-3/16	2-1/4	2-3/8	2-1/2	2-5/8	2-3/4	2-7/8	3	

**FD-118** 侧袖筒  
SLEEVE PLACKET BINDER



**作用:** 缝袖侧连落朴  
**用机:** 单针平车  
**Purpose:** Attach sleeve placket with lining  
**Machine:** 1 needle machine

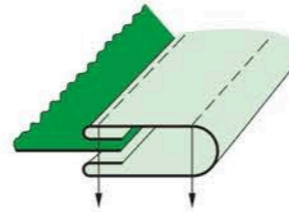

出口 Finished Size	寸 Inches	1/4	5/16	3/8	1/2	5/8	3/4	7/8	1
---------------------	-------------	-----	------	-----	-----	-----	-----	-----	---

**FD-119** 裤头筒  
WAIST BAND FOLDER

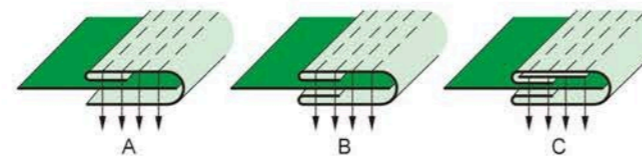

**作用:** 缝折裤头、裙头  
**用机:** 2或4针裤头车  
**Purpose:** Binding of waist band  
**Machine:** 2 or 4 needle waist band machine

出口 Finished Size	寸 Inches	1	1-1/8	1-1/4	1-3/8	1-1/2	1-1/2	1-5/8	1-3/4	1-7/4	2	2-1/4	2-1/2
入口 Tape Size	寸 Inches	2-3/4	2-3/4	3-1/4	3-1/2	3-3/4	4	4	4-1/4	4-1/2	4-3/4	5-1/4	5-1/4

**FD-120** 上下布弯裤头筒  
TWO PIECED CURVE WAIST BAND FOLDER



**作用:** 缝折弯裤头  
**用机:** 2或4针裤头车  
**Purpose:** Attach curve waist band  
**Machine:** 2 or 4 needle waist band machine

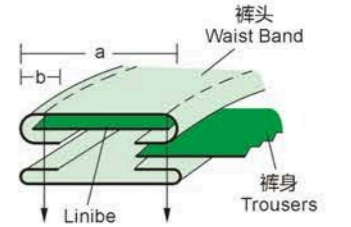

尺寸 Size	a	1-1/4	1-3/8	1-1/2	1-5/8	1-3/4
寸 Inches	b	1/4				
入口 IN	2-1/4	2-3/8	2-1/2	2-5/8	2-3/8	

**FD-121** 假反明筒  
IMMIATION SLEEVE FOLDER  
AT45A



**作用:** 男女衫前胸明筒一有朴  
**用机:** 2或4针筒车  
**Purpose:** Top centet plait of shirt and blouse-with lining  
**Machine:** 2 or 4 needle machine

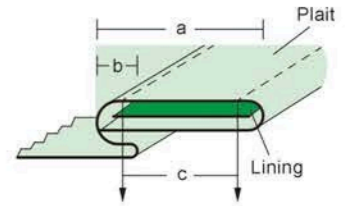

尺寸 Size	a	1	1-1/8	1-3-16	1-1/4	1-3/8	1-1/2						
寸 Inch	b	1/4	5/16	1/4	1/16	1/4	5/16	1/4	5/16	1/4	5/16	1/4	5/16
入口 IN	5/8	1/2	3/4	5/8	13/16	11/16	7/8	3/4	1	1/8	1-1/8	1	

**FD-122** 包松紧带卷边筒  
DOWN TURN ELASTIC HEMMER  
AT23

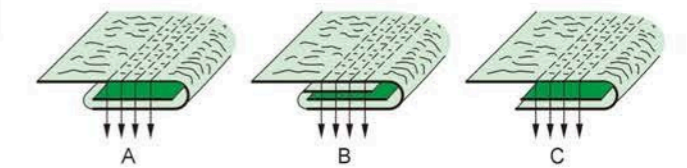

**作用:** 厚身包橡筋裤头  
**用机:** 2、3、4针橡筋车  
**Purpose:** Hemming waist band with elastic  
**Machine:** 2, 3, 4 needle elastic machine

尺寸 Size	橡筋 Elastic	1/4	1	1-1/8	1-1/4	1-3/8	1-1/2	1-5/8	1-3/4
寸 Inch	b	3/8	1/2						

**FD-124** 双针后袋筒  
BACK POCKET HEMMER

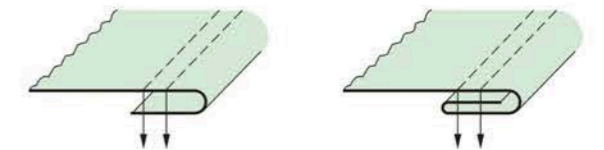

**作用:** 袋口向下环折  
**用机:** 双针车  
**Purpose:** Down turn back pocket hemming  
**Machine:** 2 needle machine

出口 Finished Size	寸 Inches	3/8	1/2
---------------------	-------------	-----	-----

**FD-126** 耳仔筒  
A36 BELT LOOP FOLDER



作用：车耳仔  
用机：单针耳仔车  
Purpose: Belt loop  
Machine: 2 needle belt loop machine

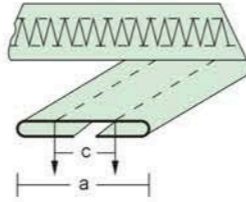

尺寸 Size	a	5/16	3/8	1/2	5/8	3/4	7/8	1
入口IN	5/8	3/4	1	1-1/4	1-1/2	1-3/4	2	
寸 Inch	c	1/4						

**FD-127** 耳仔筒  
BELT LOOP FOLDER



作用：车耳仔 用机：单针耳仔车  
Purpose: Belt loop  
Machine: 2 needle belt loop machine

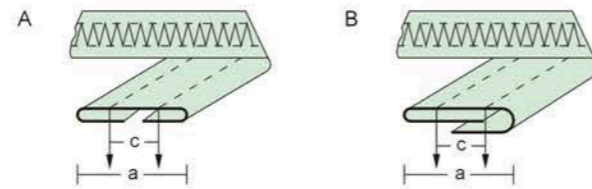

尺寸 Size	a	3/8	1/2	5/8	3/4	7/8	1	
入口IN	7/8	1-1/8	1-3/8	1-5/8	1-7/8	2-1/8		
寸 Inch	c	1/4						

**FD-128** 耳仔筒  
A36C BELT LOOP FOLDER



作用：车耳仔 用机：双针耳仔车连前切刀  
Purpose: Belt loop  
Machine: 2 needle belt loop machine with front cutter

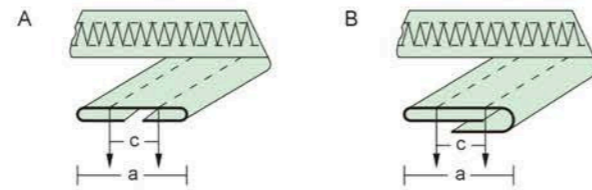

尺寸 Size	a	3/8	1/2	5/8	3/4
入口IN	7/8	1-1/8	1-3/8	1-5/8	
寸 Inch	c	1/4			

**FD-129** 耳仔筒 (天工)  
BELT LOOP FOLDER



作用：天工耳仔筒 用机：双针耳仔车连前切刀  
Purpose: Belt loop  
Machine: 2 needle belt loop machine with front cutter

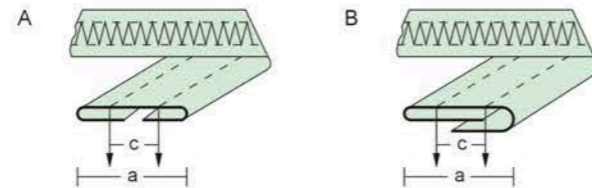

标准厚度 Standard Thickness	尺寸 Size	a	3/8	1/2	5/8	3/4
S M	入口IN	7/8	1-1/8	1-3/8	1-5/8	
	寸 Inch	c	1/4			

**FD-130** 日字埋夹筒  
A30 SIDE SEAM FOLDER-JAPAN STYLE



作用：薄布埋夹用  
用机：日本2、3针埋夹车  
Purpose: Sew side seam of light weight fabric  
Machine: Japan made 2, 3 needle feed of arm machine

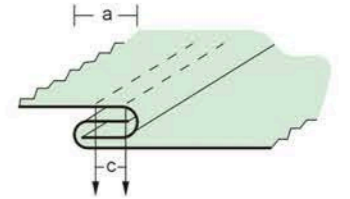

尺寸 Size	a	3/16	5/16	3/8
寸 Inch	c	1/8	3/16	1/4

**FD-131** 双针上袖筒  
A32 DOUBLE NEEDLE LAP SEAM FOLDER



作用：缝薄布或恤衫后幅  
用机：双针车  
Purpose: Back seam of shirt of light weight fabric  
Machine: 2 needle machine

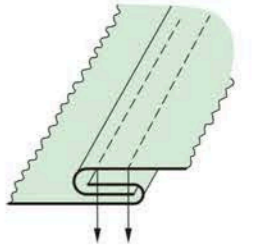

尺寸 Size	a	3/16	5/16	3/8
寸 Inch	c	1/8	3/16	1/4

**FD-132** 於仁埋夹筒  
35800 FEED OFF- THE ARM FOLDER



作用：埋夹  
用机：迂仁2、3针埋夹车  
Purpose: Sew side seam  
Machine: 2, 3 needle union special feed of the arm machine

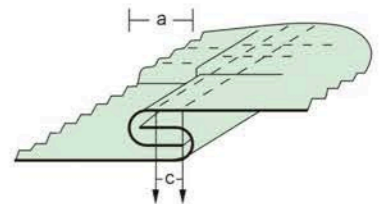

尺寸 Size	a	7/16
寸 Inch	c	9/32

**FD-133** 双针上袖筒  
A34 DOUBLE NEEDLE LAP SEAM FOLDER



作用：缝薄布或恤衫后幅  
用机：双针上袖车  
Purpose: Back seam of shirt or light weight fabric  
Machine: 2 needle machine

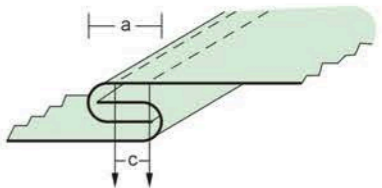

尺寸 Size	a	5/16	3/8
寸 Inch	c	3/16	1/4

**FD-134** 双针埋夹筒  
LAP SEAM FOLDER FOR DOUBLE NEEDLE MACHINE



作用：缝薄布或恤衫后幅  
用机：双针上袖车  
Purpose:  
Back seam of shirt or light weight fabric  
Machine:  
2 needle machine

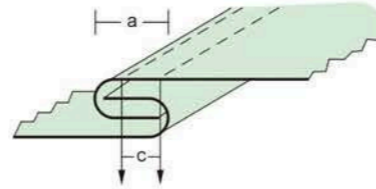

尺寸 Size	a	5/16	3/8
寸 Inch	c	3/16	1/4

**FD-135**  
A31 埋夹筒  
SIDE SEAM STYLE



作用：缝薄布或恤衫后幅  
用机：双针上袖车  
Purpose:  
Back seam of shirt or light weight fabric  
Machine:  
2 needle machine

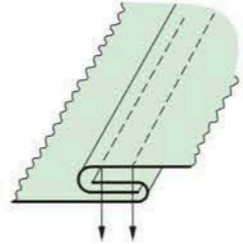

尺寸 Size	a	5/16	3/8
寸 Inch	c	3/16	1/4

**FD-136** 单针袖筒-双针车用  
SINGLE NEEDLE SLEEVE ATTACHING-DOUBLE NEEDLE OPERATION



作用：单针袖  
用机：单针平车  
Purpose:  
single needle sleeve  
Machine:  
1 needle lockstitch machine

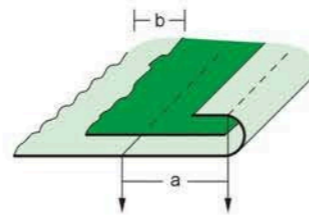

尺寸 Size	寸 Inch	1/4	3/16
------------	-----------	-----	------

**FD-137** 双针袖筒-双针车用  
DOUBLE NEEDLE SLEEVE ATTACHING-DOUBLE NEEDLE OPERATION

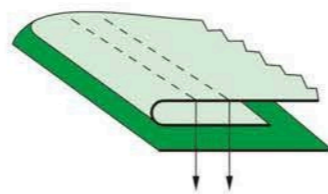

尺寸 Size	寸 Inch	1/4	3/16
------------	-----------	-----	------

**FD-138** 飞马包缝机拉筒  
EDGE BINDER FOR PEGASUS OVERLOCK MACHINE



作用：口袋边包缝  
用机：飞马L22-OE  
Purpose:  
Pocket binding  
Machine:  
PEGASUS L22

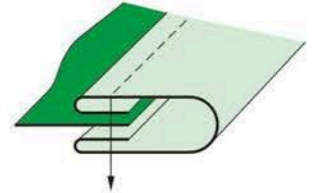

尺寸 Size	入口 IN	24mm	26mm
------------	----------	------	------

**FD-139** 银箭包缝机拉筒  
EDGE BINDER FOR SIRUBA OVERLOCK MACHINE



作用：口袋边包缝  
用机：银箭757E  
Purpose:  
Pocket binding  
Machine:  
SIRUBA 757E

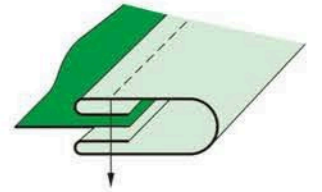

尺寸 Size	入口 IN	24mm	26mm
------------	----------	------	------

**FD-140** 宝狮包缝机拉筒  
EDGE BINDER FOR KINGTEX OVERLOCK MACHINE



作用：口袋边包缝  
用机：宝狮6034  
Purpose:  
Pocket binding  
Machine:  
KINGTEX 6034

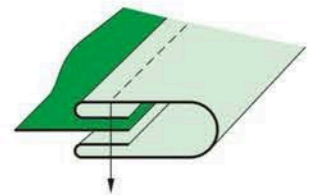

尺寸 Size	入口 IN	24mm	26mm
------------	----------	------	------

**FD-141** 单折包边筒  
SINGLE FOLD EDGE BINDER



作用：布衣  
用机：单针平车  
Purpose:  
Edge binder (Plastic)  
Machine:  
1-needle lockstitch machine

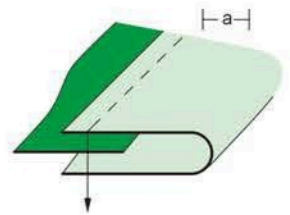

尺寸 Size	a	3/8	7/16	1/2
寸 Inch	入口 IN	3/4	7/8	1

**FD-143** 皮革包边筒  
AT8 EDGE BINDER FOR SINGLE NEEDLE MACHINE

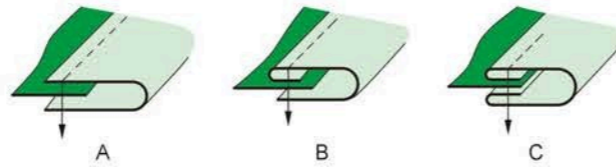

作用：薄物、薄皮革 用机：单针车  
Purpose: Thin light material  
Machine: 1-needle lockstitch machine

尺寸 Size	入口 IN	8mm	10mm	12mm	14mm	16mm	18mm	20mm	22mm
------------	----------	-----	------	------	------	------	------	------	------

**FD-144** 平车直角包边筒  
A10 RIGHT ANGLE BIAS BINDER



作用：弯布边  
用机：单针平车  
Purpose: Binding of curve edge  
Machine: 1 needle lockstitch machine

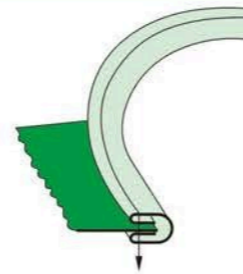

出口 Finished Size	mm	4	4.5	5	5.5	6	6.5	7	8	8.5	10	11.5	13	16
	入口 Tape Size	mm	16	18	20	22	24	26	28	30	32	36	40	45
	Inch	5/8	11/16	3/4	7/8	15/16	1	1	1-3/16	1-1/4	1-7/16	1-1/2	1-3/4	2

**FD-146** 拉脚筒  
S72LAJ RIGHT ANGLE BINDER



作用：恤衫圆脚或一般折边用  
用机：单针平车  
Purpose: Shirt round bottom and general  
Machine: 1-needle lockstitch machine

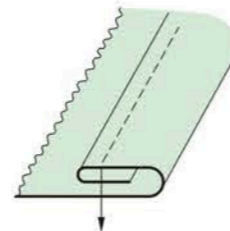

尺寸 Size	寸 Inch	1/8	3/16	1/4	5/16	3/8	1/2	5/8	3/4	7/8	1
------------	-----------	-----	------	-----	------	-----	-----	-----	-----	-----	---

**FD-147** 拉圆脚筒  
A11 SHORT TAIL SWING HEMMER



作用：恤衫圆脚或一般折边用  
用机：单针平车  
Purpose: Shirt round bottom and general  
Machine: 1-needle lockstitch machine

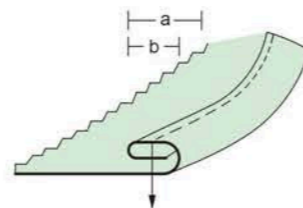

尺寸 Size	寸 Inch	1/8	3/16	1/4	5/16	3/8	1/2	5/8	3/4	7/8	1
------------	-----------	-----	------	-----	------	-----	-----	-----	-----	-----	---

**FD-148** 弹弓嘴拉脚筒  
A70 SPRING TYPE SWING HEMMER



作用：折边用、筒嘴有弹性  
用机：单针平车  
Purpose: General hemming spring socket allows cross seam pass  
Machine: 1 needle lockstitch machine

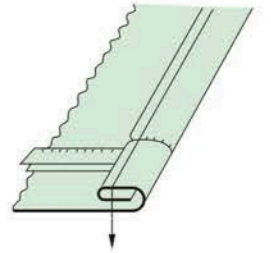

出口 Finished Size	mm	3.2	4.8	6.4	9.5	12.7
	Inch	1/8	3/16	1/4	3/8	1/2

**FD-149** 拉下级筒  
SINGLE UP TURN FOLDER



作用：折下级袖口用  
用机：单针平车  
Purpose: Single up turn folding of general purpose  
Machine: 1 needle lockstitch machine

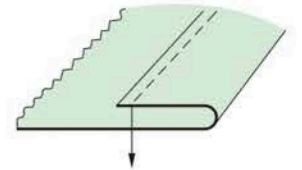

出口 Finished Size	1/8	3/16	1/4	5/16	3/8	7/16	1/2
寸 Inch	5/8	3/4	7/8	1	1-1/8	1-1/4	1-1/2

**FD-150** 纽仔筒  
PLAIT FOLDER



作用：男女恤纽仔  
用机：单针平车  
Purpose: Button plait  
Machine: 1 needle lockstitch machine

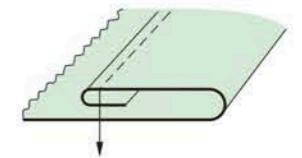

出口 Finished Size	寸 Inch	3/4	7/8	1	1-1/8	1-1/4	1-3/8	1-1/2
---------------------	-----------	-----	-----	---	-------	-------	-------	-------

**FD-151** 散口曲嘴包边筒  
A4 EDGE BINDER



作用：包硬身布料  
用机：单针平车  
Purpose: Binding of curve edge  
Machine: 1 needle lockstitch machine

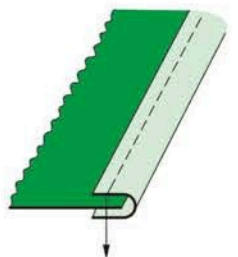

出口 Finished Size	mm	9.5	12.7	15.9	19.0	22.2	25.4
	Inch	3/8	1/2	5/8	3/4	7/8	1

**FD-152** 曲嘴包边筒  
A9 EDGE BINDER



**作用:** 包一般曲位布边  
**用机:** 单针平车  
**Purpose:** General binding of curve edge  
**Machine:** 1 needle lockstitch machine

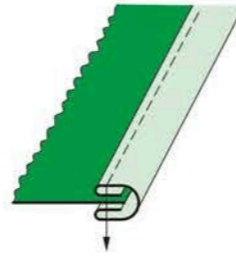

出口 Finished Size	mm	16	20	22	26	28	32	40
	Inch	5/8	3/4	7/8	1	1-1/8	1-1/4	1-1/2

**FD-153** 拉筒带  
A5 BELT & LOOP FOLDER



**作用:** 车带  
**用机:** 单针平车  
**Purpose:** Loop belt sewing  
**Machine:** 1 needle lockstitch machine

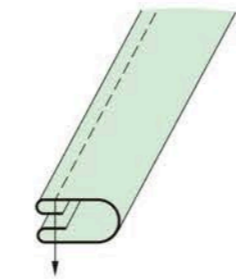

出口 Finished Size	mm	5	8	10	12	15	18	20	22	24	30
	Inch										

**FD-155** 折边筒  
A400 PLAIN HEMMER



**作用:** 一般上折布边如领下级  
**用机:** 单针平车  
**Purpose:** Single up turn folding of general purpose  
**Machine:** 1 needle placket machine

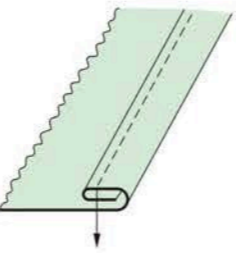

出口 Finished Size	mm	1.6	3.2	4.8	6.4	9.5	12.7
	Inch	1/16	1/8	3/16	1/4	3/8	1/2

**FD-156** 下折散口拉脚筒  
A75D SINGLE DOWNTURN ELLER



**作用:** 一般上折布边如领下级  
**用机:** 单针平车  
**Purpose:** Single up turn folding of general purpose  
**Machine:** 1 needle placket machine

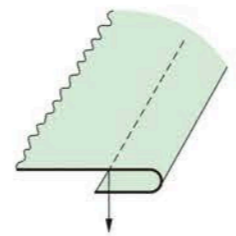

出口 Finished Size	mm	4.8	6.4	8.0	9.5	12.7	15.9	19.0	22.2	25.4
	Inch	3/16	1/4	5/16	3/8	1/2	5/8	3/4	7/8	1

**FD-157** 散口拉脚筒  
A75U SINGLE UPTURN FELLER



**作用:** 一般上折布边如领下级  
**用机:** 单针平车  
**Purpose:** Single up turn folding of general purpose  
**Machine:** 1 needle placket machine

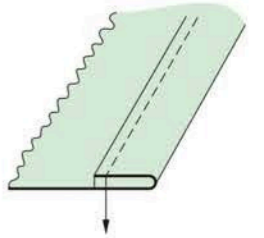

出口 Finished Size	mm	4.8	6.4	8.0	9.5	12.7	15.9	19.0	22.2	25.4
	Inch	3/16	1/4	5/16	3/8	1/2	5/8	3/4	7/8	1

**FD-158** 绳子筒  
PIPING FOLDER



**作用:** 车捆条连绳仔, 用于睡衣, 枕头袋等  
**用机:** 单针平车  
**Purpose:** Attach piping with sting e.g. pajama and pillow case  
**Machine:** 1-needle lockstitch machine

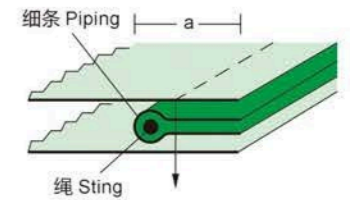

尺寸 Size	a	3/8	7/16	1/2	5/8
	入口IN	3/4	7/8	1	1-1/4
寸 Inches	绳 Sting	1/16~1/8		3/16	

**FD-159** 银箭管条包边筒  
PIPING FOLDERC (SIRUBA)



**作用:** 车细条连绳仔, 用于睡衣, 枕头袋等  
**用机:** 单针平车, 4或5线级骨车  
**Purpose:** Attach piping with sting e.g. pajama and pillow case  
**Machine:** 1-needle lockstitch machine

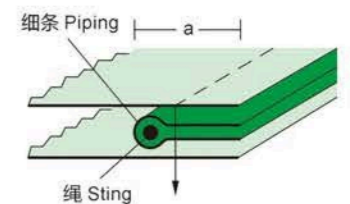

尺寸 Size	a	3/8	7/16	1/2	5/8	3/4	7/8	1	1-1/4
	入口IN	3/8	7/16	1/2	5/8	3/4	7/8	1	1-1/4
寸 Inches	绳 Sting	1/16~1/8		3/16					

**FD-160** 绳子筒  
A46A CORD EDGE PIPING ATTACHMENT

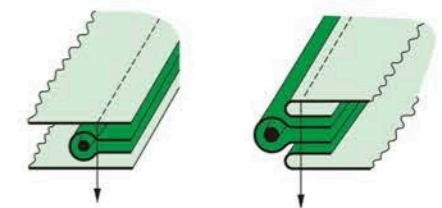

Max. Cord	mm	1.8	2.2	2.8			
出口 Finished Size	mm	15	17	20	23	25	28
	Inch	9/16	5/8	3/4	7/8	1	1-1/8

### FD-161 双针面贴捆条压脚筒 TAPE ATTACH FOLDER FOOT



**作用:** 车双针面贴  
**用机:** 双针车  
**Purpose:**  
Attach tape on top of fabric  
surface e.g. jogging suit  
**Machine:**  
2 needle machine

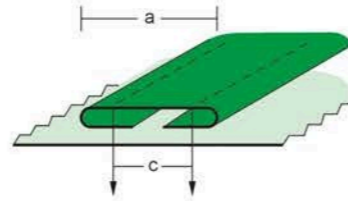

尺寸 Size	a	3/8	1/2	5/8	3/4	7/8	1	1-1/8
寸	c	1/4	3/8	1/2	5/8	3/4	7/8	1
Inches	入口IN	7/8	1-1/8	1-3/8	1-1/2	1-5/8	1-3/4	1-7/8

### FD-162 可调双针折边筒 ADJUSTABLE SINGLE UPTURN HEMMER



**作用:** 帽、针  
**用机:** 2、4针车用  
**Purpose:**  
Hat folder  
**Machine:**  
2, 4 needle machine

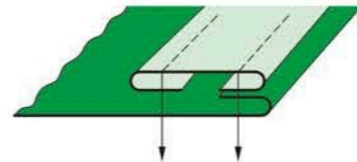

尺寸: 1/8-1/2 可调

### FD-163 双针捆条贴边筒 LINING TAPE ATTACHING FOLDER

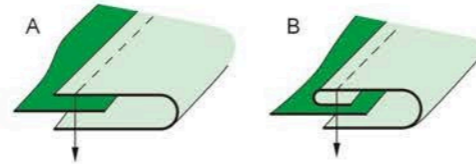

**用机:** 双针车  
**Machine:** 2 needle machine

尺寸 Size	mm	15	18	20	22	24
------------	----	----	----	----	----	----

### FD-165 多条面贴筒 MULTI TAPE ATTACH FOLDER



**作用:** 机袖装式面贴用  
**用机:** 多针车  
**Purpose:**  
Decorative tape on jacket  
**Machine:**  
Multi needle machine

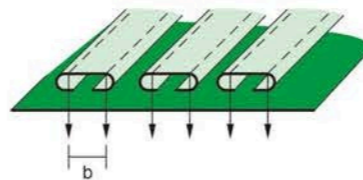

尺寸 Size	a	7/32	9/32	5/8
寸	b	7/8	3/16	1/4
Inches	入口IN	1/2	3/4	7/8

### FD-166 胸围筒 LINING TAPE ATTACHING FOLDER



**作用:** 胸围  
**用机:** 双针车  
**Purpose:**  
Brassiere & Corset  
**Machine:**  
Double needle machine

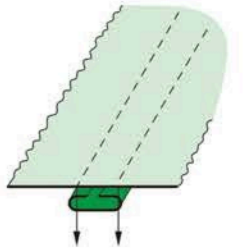

Max. Cord	15mm	18"	20"	22"	24"
出口 Finished Size	3.2mm	4.8mm	6.4mm	80"	6"
	1/8"	4.8"	1/4"	5/16"	3/8"

### FD-167 汗带筒 BELT LOOP FOLDER



**作用:** 车帽  
**用机:** 2、4针车用  
**Purpose:**  
Hat folder  
**Machine:**  
2, 4 needle machine

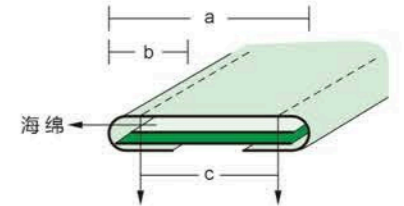

标准厚度 Standard Thickness	尺寸 Size	a	1	1-1/8	1-1/4	1-5/8
S	寸 Inch	b	1-5/8	1-3/4	1-7/8	2-1/4

### FD-168 开骨帽筒 TAP ATTACHING FOLDER (OPEN SEAM)



**作用:** 车帽开骨  
**用机:** 2、4针车用  
**Purpose:**  
Hat folder  
**Machine:**  
2, 4 needle machine

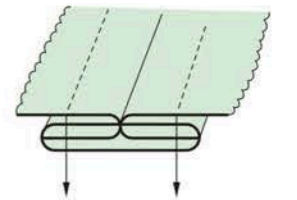

标准厚度 Standard Thickness	尺寸 Size	a	1/2	9/16
S	寸 Inch	b	1	1-1/8

### FD-170 反猪肠筒 SPAGHETTI ATTACHMENT



**作用:** 车暗线  
**用机:** 单针平车  
**Purpose:**  
Make Spaghetti like tube  
**Machine:**  
1 needle lockstich machine

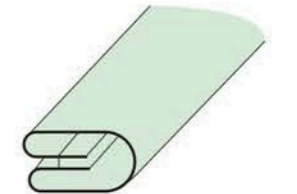

出口 Finished Size	寸 Inch	1/8	5/16	3/16	3/8	1/4	1/2
---------------------	-----------	-----	------	------	-----	-----	-----

**FD-171** 细嘴包边筒  
BINDER FOR SMALL-SIZED CYLINDER BED MACHINE

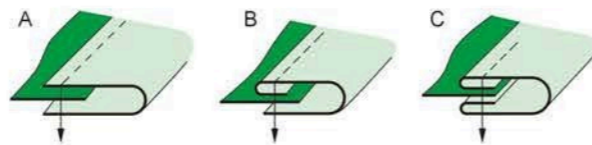

作用：细弯料 用机：筒形单针车  
Purpose: Curve edge binder  
Machine: Cylinder-bed machine

入口 IN	mm	8	10	12	14	16	18	20	22
----------	----	---	----	----	----	----	----	----	----

**FD-172** 雨伞筒  
TWIN PLAIN HEMMER

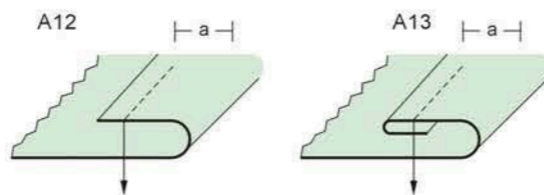

作用：拉伞边 用机：单针平车  
Purpose: Umbrella edge hemmer  
Machine: 1-needle lock stitch machine

出口 Finished Size	a	mm	2.5~3	3~4
---------------------	---	----	-------	-----

**FD-173** 上下级拉带筒  
TWO PLECE BELT LOOP FOLDER

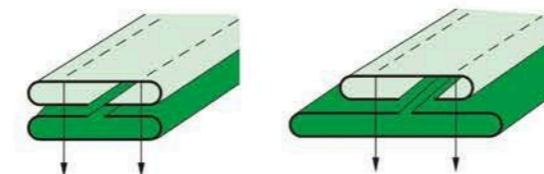

作用：皮革拉带 用机：双针机  
Purpose: Belt for leather  
Machine: 2-needle machine

出口 Finished Size	寸 Inches	5/8	3/4	3/8	1	1-1/8	1-1/4	1-3/8	1-1/2
入口 IN	寸 Inches	1-1/4	1-1/2	1-3/4	2	2-1/4	2-1/2	2-3/4	3

**FD-174** 毛毡筒  
BLANKET BINDER



作用：毛毡细边 用机：飞马W-500座车  
Purpose: Blanket binder  
Machine: PEGASUS W500 series

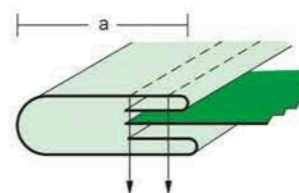

尺寸 Size	a	40	30
mm	入口IN	100	80

**FD-176** 包边筒  
BINDER



尺寸：定制  
Size: Customize

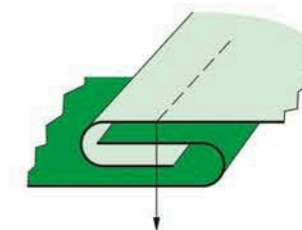

**FD-177** 横筒裤头筒  
RIGHT ANGLE WAIST BAND FOLDER



作用：缝折裤头、裙头  
用机：2、4针裤头车  
Purpose: Binding of waist band  
Machine: 2, 4 needle waist band Machine

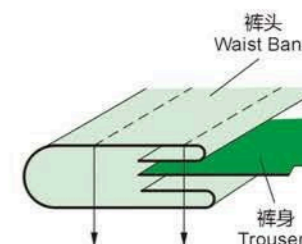

**FD-178** 床垫包边筒  
MATTRESS BINDER (UNSION FEED MACHINE)



作用：床垫捆边  
用机：高头8B  
Purpose: Mattress binder  
Machine: One-needle unson feed machine

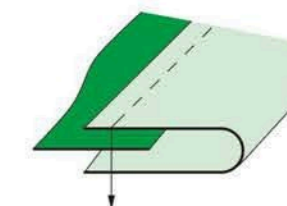

标准厚度 Standard Thickness	L	XL	入口IN	mm	45	50	60
----------------------------	---	----	------	----	----	----	----

**FD-179** 折边靴  
HEMMER FOOT



作用：折边用  
用机：单针平车  
Purpose: General hemming  
Machine: 1 needle lockstitch machine

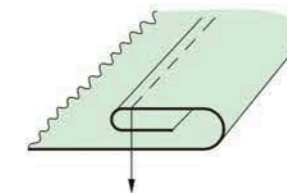

尺寸 Size	mm	1.6	3.2	4.8	6.4
	Inch	1/16	1/8	3/16	1/4

**FD-180** 橡根蚨靴  
ELASTIC SHIRRING FOOT  
AT227

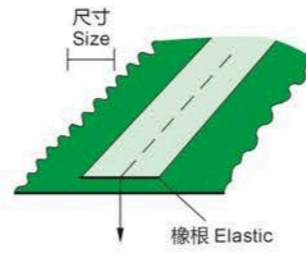

标准厚度 Standard Thickness	T	尺寸 Size	寸 Inch	1/8	3/16	1/4
----------------------------	---	------------	-----------	-----	------	-----

**FD-181** 折边靴  
HEMMER FOOT  
490358



作用：折边用  
用机：单针平车  
Purpose:  
General hemming  
Machine:  
1 needle lockstitch  
machine

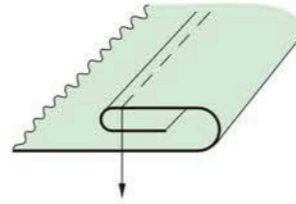

尺寸 Size	寸 Inch	1/8	3/16	1/4	5/16
------------	-----------	-----	------	-----	------

**FD-183** 绳子筒  
PIPING FOLDER



作用：车捆条连绳仔，  
用于睡衣，枕头袋等  
用机：单针平车  
Purpose:  
Attach piping with sting  
e.g.pajama and pillow case  
Machine:  
1-needle lockstitch  
machine

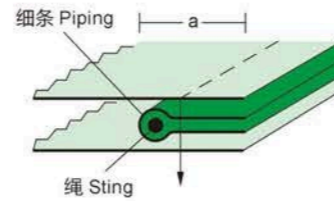

尺寸 Size	a	3/8	7/16	1/2	5/8
寸 Inch	入口IN	3/4	7/8	1	1-1/4
	绳 Sting	1/16~1/8		3/16	

**FD-184** 绳子筒  
PIPING FOLDER



作用：车捆条连绳仔，  
用于睡衣，枕头袋等  
用机：单针平车  
Purpose:  
Attach piping with sting  
e.g.pajama and pillow case  
Machine:  
1-needle lockstitch  
machine

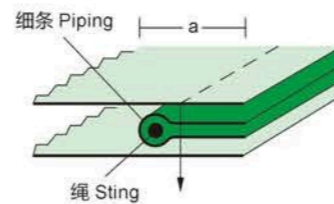

尺寸 Size	a	3/8	7/16	1/2	5/8
寸 Inch	入口IN	3/4	7/8	1	1-1/4
	绳 Sting	1/16~1/8		3/16	

**FD-185** 绳子筒  
PIPING FOLDER



作用：车捆条连绳仔，  
用于睡衣，枕头袋等  
用机：单针平车  
Purpose:  
Attach piping with sting  
e.g.pajama and pillow case  
Machine:  
1-needle lockstitch  
machine

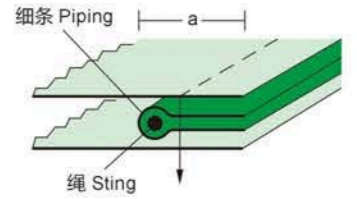

尺寸 Size	a	3/8	7/16	1/2	5/8
寸 Inch	入口IN	3/4	7/8	1	1-1/4
	绳 Sting	1/16~1/8		3/16	

**FD-186** 绳子筒  
PIPING FOLDER



作用：车捆条连绳仔  
用机：单针平车  
Purpose:  
Attach piping  
Machine:  
1-needle lockstitch  
machine

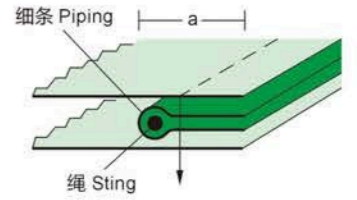

尺寸 Size	a	3/8	7/16	1/2	5/8
寸 Inch	入口IN	3/4	7/8	1	1-1/4
	绳 Sting	1/16~1/8		3/16	

**FD-187** 绳子筒  
PIPING FOLDER



作用：车捆条连绳仔  
用机：单针平车  
Purpose:  
Attach piping  
Machine:  
1-needle lockstitch  
machine

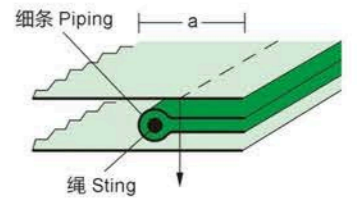

尺寸 Size	a	3/8	7/16	1/2	5/8
寸 Inch	入口IN	3/4	7/8	1	1-1/4
	绳 Sting	1/16~1/8		3/16	

**FD-188** 绳子筒  
PIPING FOLDER



作用：车捆条连绳仔  
用机：单针平车  
Purpose:  
Attach piping  
Machine:  
1-needle lockstitch  
machine

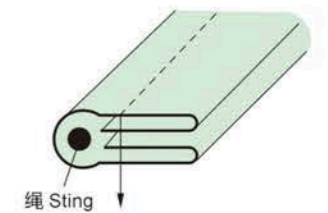

尺寸 Size	a	3/8	7/16	1/2	5/8
寸 Inch	入口IN	3/4	7/8	1	1-1/4
	绳 Sting	1/16~1/8		3/16	

### FD-189 绳子筒 PIPING FOLDER



**作用:** 车捆条连绳仔  
**用机:** 单针平车  
**Purpose:** Attach piping  
**Machine:** 1-needle lockstitch machine

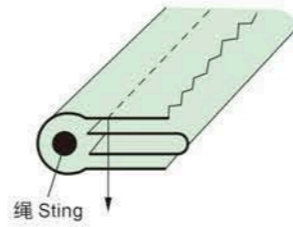

尺寸 Size	a	3/8	7/16	1/2	5/8
寸 Inch	入口IN	3/4	7/8	1	1-1/4
	绳 Sting	1/16~1/8		3/16	

### FD-190 绳子筒 PIPING FOLDER



**作用:** 车细条连绳仔  
**用机:** 单针平车  
**Purpose:** Attach piping  
**Machine:** 1-needle lockstitch machine

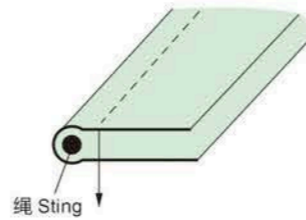

尺寸 Size	a	3/8	7/16	1/2	5/8
寸 Inch	入口IN	3/4	7/8	1	1-1/4
	绳 Sting	1/16~1/8		3/16	

### FD-191 底橡筋筒 BOTTOM ELASTIC FOLDER

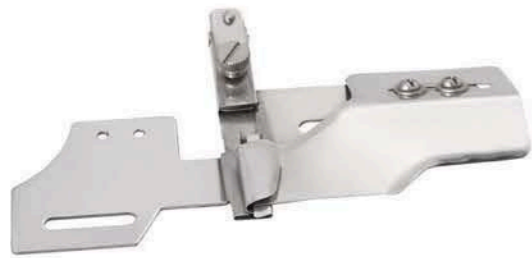

**用机:** 双针车  
**Machine:** 2 needle machine

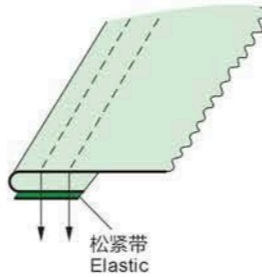

### FD-192 胸罩面贴筒 BRAS SIERE ATTA CHMENT



**用机:** 双针车  
**Machine:** 2 needle machine

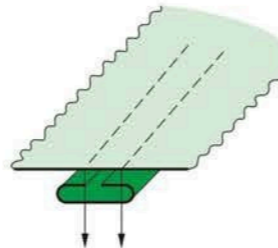

### FD-194 双针反耳仔筒 REVERSE-BELT LOOP FOLDER



**作用:** 车反耳仔筒  
**用机:** 双针车  
**Purpose:** Belt loop  
**Machine:** 2 needle machine

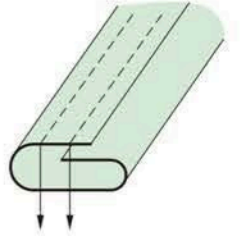

尺寸 Size	入口 Tape Size	3/4	1	1-1/4	1-1/2	1-3/4	2
寸 Inch	出口 Finished Size	3/8	1/2	5/8	3/4	7/8	1

### FD-201 散口拉脚筒 (弹力布) SHIRT ROUND BOTTOM AND GENERAL



**作用:** 恤衫圆脚或一般折边用  
**用机:** 单针平车  
**Purpose:** Shirt round bottom and general  
**Machine:** 1-needle lockstitch machine

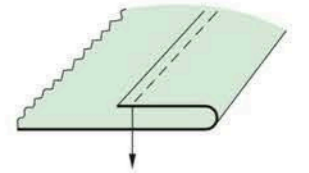

### FD-203 耳仔筒 BELT LOOP FOLDER



**作用:** 车耳仔  
**用机:** 双针耳仔车连前切刀  
**Purpose:** Belt loop  
**Machine:** 2 needle belt loop machine with front cutter

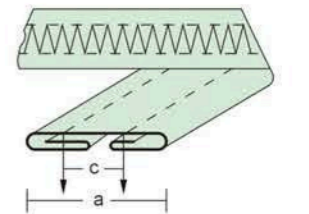

### FD-204 底贴裤头筒 BOTTOM WAIST BAND FOLDER



**作用:** 缝折裤头  
**用机:** 2或4针裤头车  
**Purpose:** Attach waist band  
**Machine:** 2 or 4 needle waist band machine

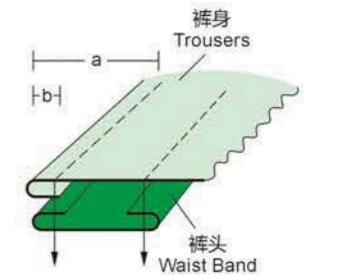

尺寸 Size	寸 Inch	3/8	1/2
------------	-----------	-----	-----

**FD-205** 单针接袖筒  
SINGLE NEEDLE SLEEVE ATTACHMENT

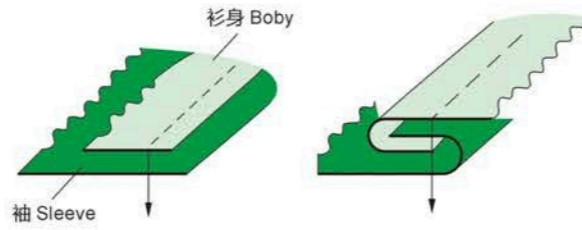

作用：单针袖 用机：单针平车  
Purpose: Single needle sleeve  
Machine: 1 needle lockstitch machine

尺寸 Size	寸 Inch	1/4	5/16	3/8
------------	-----------	-----	------	-----

**FD-206** 双折插筒  
RIGHT BINDER

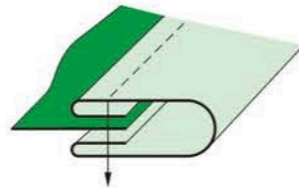

尺寸：定制  
Size: Customize

**FD-210** 底贴裤头筒  
BOTTOM WAIST BAND FOLDER

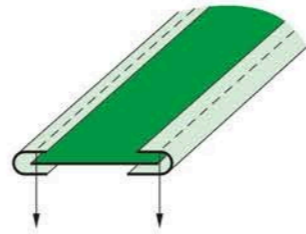

尺寸：定制  
Size: Customize

**FD-211** 西裤贴系列  
CASUAL TROUSERS WAIST BAND FOLDER

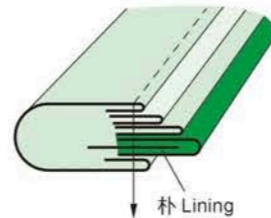
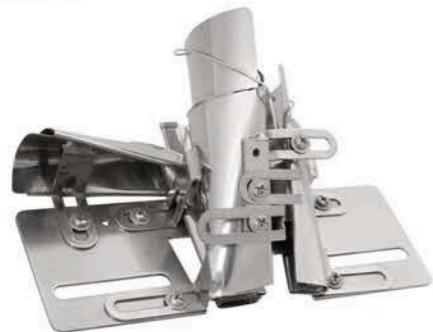

尺寸：定制  
Size: Customize

**FD-212** 西裤贴系列  
CASUAL TROUSERS WAIST BAND FOLDER

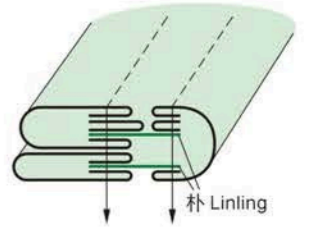

尺寸：定制  
Size: Customize

**FD-213** 长单折筒  
RIGHT ANGLE BINDER

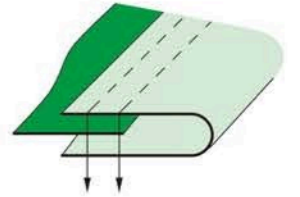

作用：拉针织T恤领、袖等  
用机：银箭、双针车  
Purpose: Binding of knitwear collar and sleeve  
Machine: SIRUBA

出口 Finished Size	寸 Inch	1/4	5/16	3/8	1/2	5/8	3/4	7/8	1
---------------------	-----------	-----	------	-----	-----	-----	-----	-----	---

**FD-214** 单折包边筒  
SINGLE FOLD EDGE BINDER

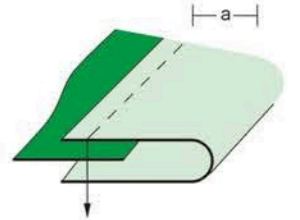

作用：布衣  
用机：单针平车  
Purpose: Edge Binder (Plastic)  
Machine: 1-needle lockstitch machine

尺寸 Size	a	3/8	7/16	1/2
寸 Inch	入口 IN	3/4	7/8	1

**FD-215** 绷缝车直角包边筒（插口单折可调）  
RIGHT ANGLE BINDER

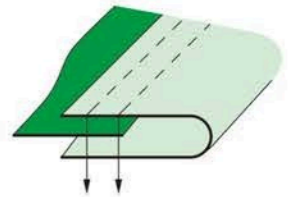

作用：拉橡筋、针织T恤领、袖等  
用机：2或3针拉口车  
Purpose: Binding of knitwear collar and sleeve. (Elastic)  
Machine: 2 or 3 needle cover stitch machine

标准厚度 Standard Thickness	MH	H						
出口 Finished Size	a Inches	1/4	5/16	3/8	7/16	1/2		
入口 Tape Size	寸 Inches	1/2	5/8	3/4	7/8	1		

**FD-216** 绷缝车直角包边筒 (插口单折可调)  
RIGHT ANGLE BINDER



**作用:** 拉橡筋、针织T恤领、袖等  
**用机:** 2或3针拉筒车  
**Purpose:** Binding of knitwear collar and sleeve. (Elastic)  
**Machine:** 2 or 3 needle cover stitch machine

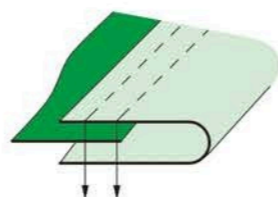

标准厚度 Standard Thickness	MH	H				
出口 a Finished Size	寸 Inches	1/4	5/16	3/8	7/16	1/2
入口 Tape Size	寸 Inches	1/2	5/8	3/4	7/8	1

**FD-217** 绷缝车直角包边筒 (插口落橡筋单折可调)  
RIGHT ANGLE BINDER FOR SWIM WEAR



**作用:** 包橡筋、泳衣、内裤  
**用机:** 2或3针拉筒车  
**Purpose:** By inserted elastic  
**Machine:** 2 or 3 needle cover stitch machine

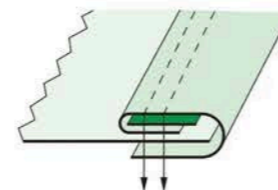

标准厚度 Standard Thickness	MH	H			
出口 a Finished Size	寸 Inches	5/16	3/8	1/2	5/8
入口 Tape Size	寸 Inches	15/16	1-1/8	1-3/8	1-5/8

**FD-218** 绷缝车直角包边筒 (插口落橡筋双折可调)  
RIGHT ANGLE BINDER FOR SWIM WEAR



**作用:** 包橡筋、泳衣、内裤  
**用机:** 2或3针拉筒车  
**Purpose:** By inserted elastic  
**Machine:** 2 or 3 needle cover stitch machine

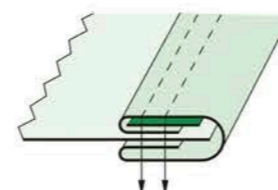

标准厚度 Standard Thickness	MH	H			
出口 a Finished Size	寸 Inches	5/16	3/8	1/2	5/8
入口 Tape Size	寸 Inches	1-1/4	1-1/2	1-3/4	2

**FD-219** 长单折筒  
RIGHT ANGLE BINDER



**作用:** 包橡筋、泳衣、内裤  
**用机:** 2或3针拉筒车  
**Purpose:** By inserted elastic  
**Machine:** 2 or 3 needle cover stitch machine

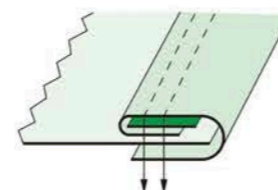

标准厚度 Standard Thickness	MH	H			
出口 a Finished Size	寸 Inches	5/16	3/8	1/2	5/8
入口 Tape Size	寸 Inches	15/16	1-1/8	1-3/8	1-5/8

**FD-220** 绷缝车直角包边筒 (插口落橡筋双折可调)  
RIGHT ANGLE BINDER FOR SWIM WEAR



**作用:** 包橡筋、泳衣、内裤  
**用机:** 2或3针拉筒车  
**Purpose:** By inserted elastic  
**Machine:** 2 or 3 needle cover stitch machine

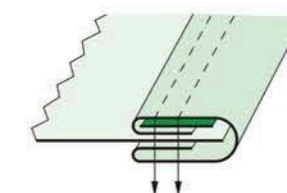

标准厚度 Standard Thickness	MH	H			
出口 a Finished Size	寸 Inches	5/16	3/8	1/2	5/8
入口 Tape Size	寸 Inches	1-1/4	1-1/2	1-3/4	2

**FD-221** 单针担杆筒  
SINGLE NEEDLE SHIRT YOKE BINDER



**作用:** 单针明线缝捍杆及后幅  
**用机:** 单针平车  
**Purpose:** Single needle top stitch attach of yoke to of yoke to back shirt  
**Machine:** 1 needle lockstitch machine

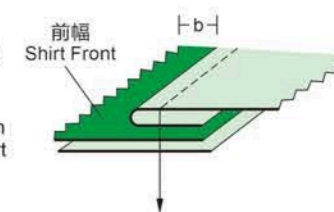

尺寸 Size	寸 Inch	b	1/4	3/8
------------	-----------	---	-----	-----

**FD-222** 单针纳膊筒  
SINGLE NEEDLE SHOULDER TOP STITCH ATTACHMENT



**作用:** 单针明线缝捍杆及后幅  
**用机:** 单针平车  
**Purpose:** Single needle top stitch attach of yoke to of yoke to back shirt  
**Machine:** 1 needle lockstitch machine

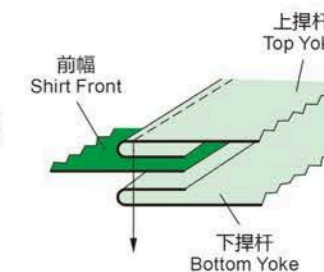

标准厚度 Standard Thickness	M	MH		
出口 a Finished Size	寸 Inches	3/8		
入口 Tape Size	寸 Inches	3/8		

**FD-223** 双针纳膊拉筒--左手  
DOUBLE NEEDLE SHOULDER TOP STITCH ATTACHMENT-LEFT



**作用:** 双针明线缝捍杆及前幅  
**用机:** 双针平车  
**Purpose:** Double needle top stitch attach of yoke to shirt front  
**Machine:** Double needle

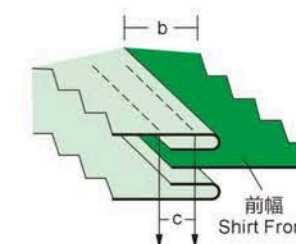

尺寸 Size	c	3/16	1/4
寸 Inch	b	3/8	

**FD-224** 双针担杆筒  
DOUBLE NEEDLE SHIRT YOKE BINDER



**作用:** 双针明线缝捍杆及后幅  
**用机:** 双针平车  
**Purpose:** Double needle top stitch attach of yoke to of yoke to back shirt  
**Machine:** Double needle

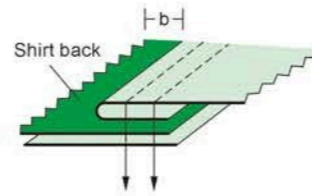

尺寸 Size	c	3/16	1/4
寸 Inch	b	3/8	

**FD-225** 双针纳膊筒  
DOUBLE NEEDLE SHOULDER TOP STITCH ATTACHMENT



**作用:** 双针明线缝捍杆及后幅  
**用机:** 双针平车  
**Purpose:** Double needle top stitch attach of yoke to back front  
**Machine:** Double needle lockstitch machine

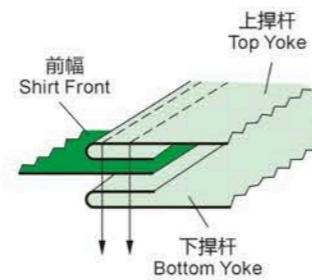

标准厚度 Standard Thickness	M	MH
出口 a Finished Size	寸 Inches	3/8
入口 Tape Size	寸 Inches	3/8

**FD-227** 单针纳膊拉筒  
SINGLE NEEDLE SHOULDER TOP STITCH ATTACHMENT



**作用:** 单针明线缝捍杆及前幅  
**用机:** 单针平车  
**Purpose:** Single needle top stitch attach of yoke to of yoke to back shirt  
**Machine:** 1 needle lockstitch machine

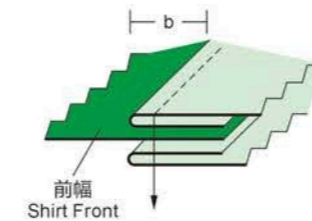

尺寸 Size	寸 Inch	b	1/2	3/8	1/4
------------	-----------	---	-----	-----	-----

**FD-228** 单针捆条绳子捍杆筒  
SINGLE NEEDLE SHIRT YOKE ATTACHMENT WITH PIPING



**作用:** 单针明线缝捍杆及后幅  
连捆条  
**用机:** 单针平车  
**Purpose:** Single needle top stitch attach of yoke to back shirt with piping  
**Machine:** Single needle lockstitch machine

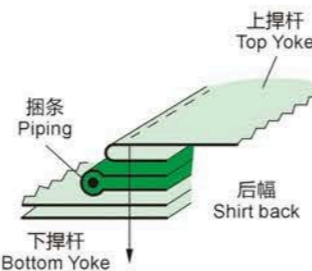

标准厚度 Standard Thickness	M	MH			
尺寸 Size	3/8	捆条	出口 a Finished Size	寸 Inches	3/8
寸 Inches			入口 Tape Size	寸 Inches	3/4

**FD-229** 双针捆条绳子捍杆筒  
DOUBLE NEEDLE SHIRT YOKE ATTACHMENT WITH PIPING



**作用:** 双针明线缝捍杆及后幅  
连捆条  
**用机:** 双针平车  
**Purpose:** Double needle top stitch attach of yoke to back shirt with piping  
**Machine:** Double needle machine

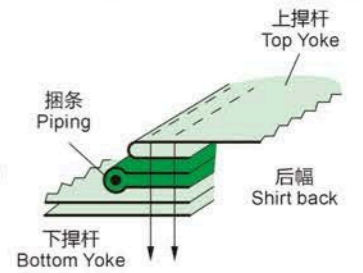

标准厚度 Standard Thickness	M	MH			
尺寸 Size	3/8	捆条	出口 a Finished Size	寸 Inches	3/8
寸 Inches			入口 Tape Size	寸 Inches	3/4

**FD-231** 袖圈贴边器  
SLEEVE FACING FOLDER



**作用:** 双针女袖底贴  
**用机:** 双针车  
**Purpose:** Lady sleeve bottom plait  
**Machine:** 2 needle machine

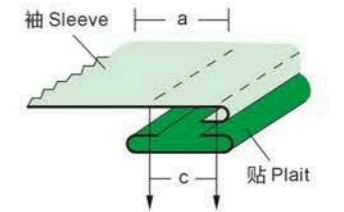

标准厚度 Standard Thickness	M	MH	
针距 c	寸 Inches	1/4	3/8
出口 a Finished Size	寸 Inches	3/8	1/2

**FD-233** 恤衫明筒  
TOP CENTER PLAITS FOLDER



**作用:** 男女恤前胸明筒-有补  
**用机:** 2或4针筒车  
**Purpose:** Top center plait of shirt and blouse-with lining  
**Machine:** 2 or 4 needle placket machine

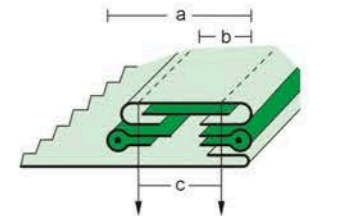

尺寸 Size	a	7/8	1	1-1/8	1-3/16	1-1/4	1-3/8	1-1/2	1-5/8	1-3/4
	b	3/8			1/2					
寸 Inch	c	5/8-3/4	3/4-7/8	3/4-1	11/16-1/8	3/4-1/8	7/8-1/4	1-1-3/8	1-1/8-1/2	1-1/4-5/8
	入口IN	1-5/8	1-3/4	1-7/8	2-3/16	2-1/4	2-3/8	2-1/2	2-5/8	2-3/4

**FD-234** 悬挂式双针带绳贴带筒  
SUSPENDED TAPE FOCADOR WITH PIPING



**作用:** 车双针面贴  
**用机:** 双针车  
**Purpose:** Attach tape on top of fabric surface  
**Machine:** 2 needle machine

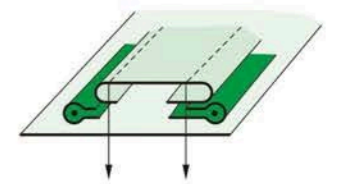

出口 a Finished Size	寸 Inches	1-1/4	1-3/8	1-1/2
入口 Tape Size	寸 Inches	2-1/4	2-3/8	2-1/2

**FD-235** 悬挂式双针带绳贴带筒  
SUSPENDED TAPE FOCODOR WITH PIPING



**作用:** 车双针面贴  
**用机:** 双针车  
**Purpose:** Attach tape on top of fabric surface  
**Machine:** 2 needle machine

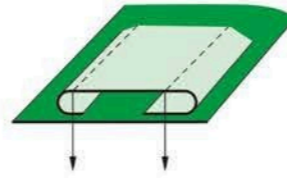

出口 a Finished Size	寸 Inches	1-1/4	1-3/8	1-1/2
入口 Tape Size	寸 Inches	2-1/4	2-3/8	2-1/2

**FD-236** 捆条袖口筒  
PLACKET BINDER WITH PIPING



**作用:** 女恤侧袖, 睡衣袖筒及裤头用有捆条  
**用机:** 单针平车  
**Purpose:** Blouse sleeve placket. Pyjama cuff placket and waist band with piping  
**Machine:** 1 needle lockstitch machine

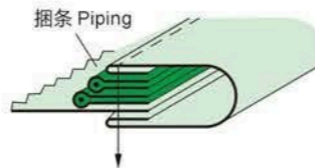

标准厚度 Standard Thickness		M	MH									
出口 a Finished Size	寸 Inches	1-1/8	1-3/16	1-1/4	1-3/8	1-1/2	1-5/8	1-3/4	1-7/8	2		
入口 Tape Size	寸 Inches	3	3-1/8	3-1/2	3-3/4	4	4-1/4	4-1/2	4-3/4	5		

**FD-237** 恤衫明筒  
TOP CENTER PLAIT FOLDER



**作用:** 男女恤前胸明筒-有朴  
**用机:** 2或4针筒车  
**Purpose:** Top center plait of shirt and blouse-with lining  
**Machine:** 2 or 4 needle placket machine

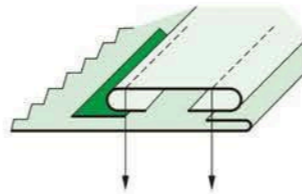

**FD-239** 拉链包边筒  
ZIPPER FOLDER



尺寸: 定制  
Size: Customize

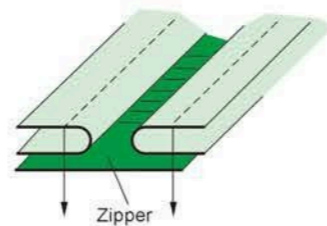

**FD-240** 捆条拉脚筒  
SWING HEMMER WITH PIPING



**作用:** 原身包橡筋裤头  
**用机:** 2、3、4针橡筋车  
**Purpose:** Hemming waist band with elastic-loose bottom  
**Machine:** 2, 3, 4 needle elastic machine

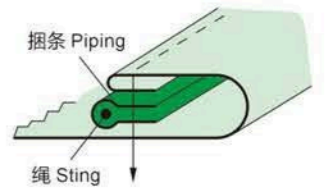

标准厚度 Standard Thickness	M	MH											
----------------------------	---	----	--	--	--	--	--	--	--	--	--	--	--

尺寸 Size	寸 Inch	1/2	5/8	3/4	7/8	1	1-1/8	1-1/4	1-3/8	1-1/2	1-5/8	1-3/4	捆条 3/4	3/8
------------	-----------	-----	-----	-----	-----	---	-------	-------	-------	-------	-------	-------	-----------	-----

**FD-241**



尺寸: 定制  
Size: Customize

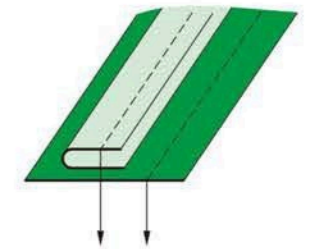

**FD-244** 包边器  
FOLDER

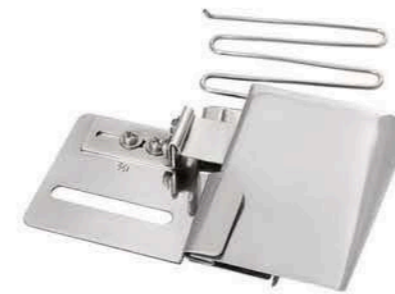

尺寸: 定制  
Size: Customize

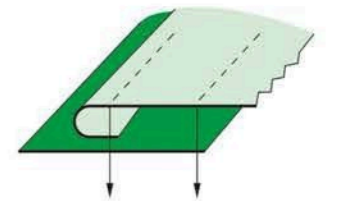

**FD-245** 包边器  
FOLDER



尺寸: 定制  
Size: Customize

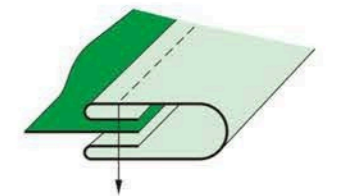

**FD-246** 暗筒折边器  
COVER PLACKET HEMMER

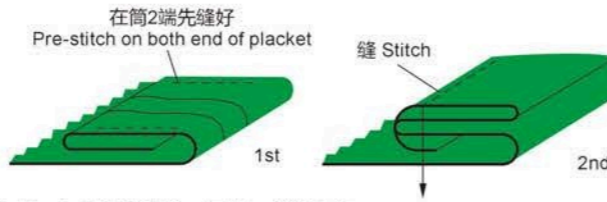

作用：女衫前胸暗筒 用机：单针平车  
Purpose: Lady blouse cover placket  
Machine: 1 needle lockstitch machine

标准厚度 Standard Thickness		M	MH					
尺寸 Size	寸 Inch	7/8	1	1-1/8	1-3/16	1-1/4	1-3/8	1-1/2

**FD-248**  
A1 双环拉筒 (家用机用)  
DOUBLE FOLD BIAS BINDER



作用：捆弯布边  
用机：家用机  
Purpose: Binding of curve edge  
Machine: Domestic sewing machine

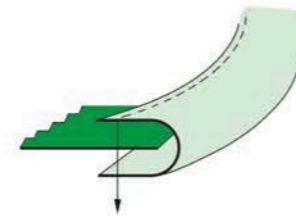

标准厚度 Standard Thickness		M	MH					
入口 Tape Size	mm	12	14	15	16	18	20	22
		24	25	26	28	30	32	

**FD-249** A10-C平车包边筒  
RIGHT ANGLE BIAS BINDER



作用：弯布边  
用机：单针平车  
Purpose: Binding of curve edge  
Machine: 1 needle lockstitch machine

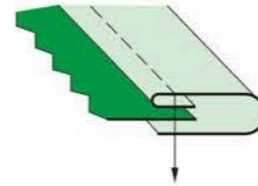

入口 Tape Size	mm	16	18	20	22	24	26	28
		30	32	36	38	40	45	50

**FD-250** A10-C平车包边筒  
RIGHT ANGLE BIAS BINDER



作用：弯布边  
用机：单针平车  
Purpose: Binding of curve edge  
Machine: 1 needle lockstitch machine

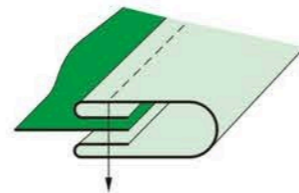

入口 Tape Size	mm	20	22	24	25	26	28	30
		32	34	35	36	40	45	50

**FD-251** 细筒筒型包边筒  
BINDER FOR SMALL-SIZED



作用：口袋边包缝  
用机：大和包缝车  
Purpose: Pocket binding  
Machine: YAMATO machine

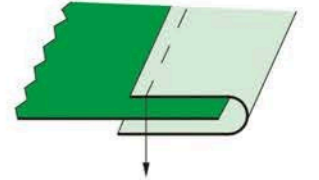

入口 Tape Size	mm	8	10	12
-----------------	----	---	----	----

**FD-252** 重机包缝车包边筒 (散口)  
EDGE BINDER FOR JUKI OVERLOCK MACHINE



作用：口袋边包缝  
用机：重机包缝车  
Purpose: Pocket binding  
Machine: JUKI machine

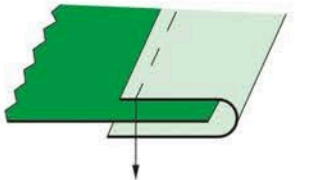

标准厚度 Standard Thickness	M	入口 Tape Size	mm	8	10	12
----------------------------	---	-----------------	----	---	----	----

**FD-253** 飞马五线包缝机拉筒  
BINDER FOR PEGASUS



作用：口袋边包缝  
用机：飞马包缝车  
Purpose: Pocket binding  
Machine: PEGASUS machine

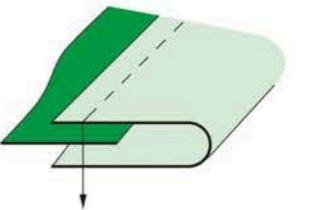

入口 Tape Size	mm	8	10	12
-----------------	----	---	----	----

**FD-254** 高头车拉筒 (鞋口)  
BINDER FOR POSTBED



作用：包鞋口边  
用机：高头车  
Purpose: Closed shoes uppers  
Machine: Postbed machine

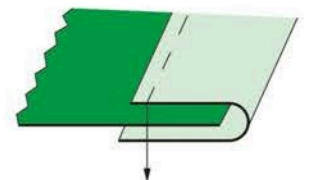

**FD-255** 耳仔筒  
BEIT LOOP FOLDER



作用：耳仔筒  
用机：双针耳仔车  
Purpose:  
Belt loop  
Machine:  
2 needle belt

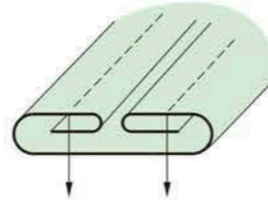

尺寸 Size	a	3/8	1/2	5/8	3/4	7/8	1
寸 Inch	入口IN	7/8	1-1/8	1-3/8	1-5/8	1-3/4	2
	c	1-4					

**FD-256** 胸罩钢线包缝器  
BRA UNDER WIRE SUPPORT ATTACHMENT



尺寸：定制  
Size: Customize

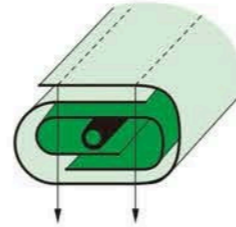

尺寸 Size	mm	8	10
------------	----	---	----

**FD-257** 环保拉筒  
ATTACHMENT



作用：包边无纺布  
用机：单针平车  
Purpose:  
Binding  
Machine:  
1 needle machine

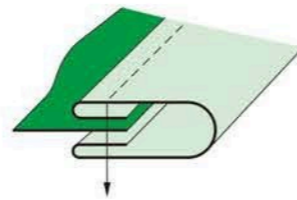

**FD-258** 包边机拉筒  
BINDER



尺寸：定制  
Size: Customize

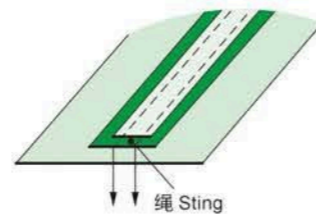

**FD-259** 包边筒  
BINDER



尺寸：定制  
Size: Customize

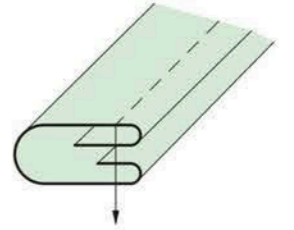

**FD-261** 包边机拉筒  
BINDER



作用：口袋边包缝  
用机：飞马包缝车  
Purpose:  
Pocket binding  
Machine:  
PEGASUS machine

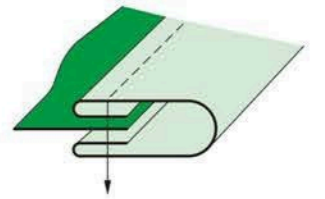

**FD-262** 平车直角拉筒加捆条  
RIGHT ANGLE BIAS BINDER WITH PIPING



作用：折布边加捆条  
用机：单针平车  
Purpose:  
General hemming with piping  
Machine:  
1 needle machine

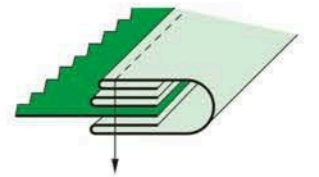

尺寸 Size	mm	20	22	24	26	28	30	32	34	36	38	40
------------	----	----	----	----	----	----	----	----	----	----	----	----

**FD-263** 绳子筒  
PIPING FOLDER



作用：车捆条连绳仔  
用机：单针平车  
Purpose:  
Attach piping  
Machine:  
1-needle lockstitch machine

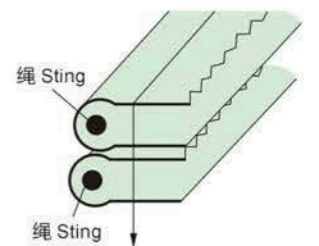

**FD-264** 活动凹脚筒  
ADJUSTABLE CLOTH GUIDE



**作用:** 拉针织T恤下摆  
**用机:** 2或3针拉筒车  
**Purpose:** Binding of knitwear collar  
**Machine:** 2 or 3 needle cover stitch machine

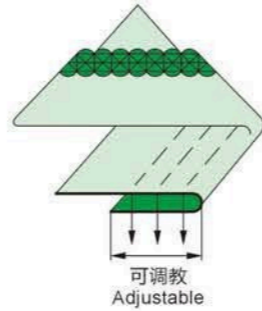

**FD-265** 绷缝车折边器  
SINGLE DOWN-TURN FOLDER FOR COVERING STITCH



**作用:** 拉针织T恤领、袖等  
**用机:** 2或3针拉筒车  
**Purpose:** Binding of knitwear collar and sleeve  
**Machine:** 2 or 3 needle cover stitch machine

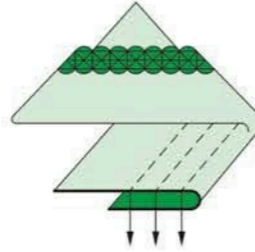

出口 Finished Size	3/8	1/2	5/8	3/4	7/8
寸 Inches	1	1-1/8	1-1/4	1-3/8	1-1/2

**FD-266** 双针反耳仔筒  
REVERSE-BELT LOOP FOLDER



**作用:** 车反耳仔筒  
**用机:** 双针车  
**Purpose:** Belt loop  
**Machine:** 2 needle machine

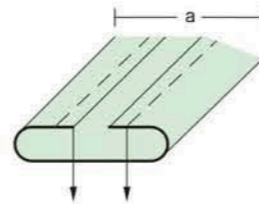

尺寸 Size	a	3/8	1/2	5/8	3/4	7/8	1
寸 Inch	入口IN	3/4	1	1-1/4	1-1/2	1-3/4	2

**FD-267** 多条面贴筒  
MULTI TAPE ATTACH FOLDER



**作用:** 机装式面贴用  
**用机:** 多针车  
**Purpose:** Decorative tape on jacket  
**Machine:** Multi needle machine

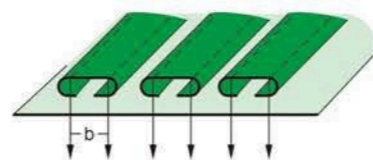

**FD-269** 包边筒  
BINDER



尺寸: 定制  
Size: Customize

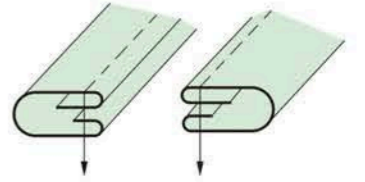

**FD-270**



尺寸: 定制  
Size: Customize

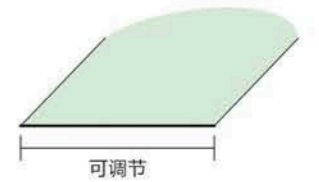

**FD-271** 暗线耳仔筒  
SPAGHETTI ATTACHMENT



**作用:** 车暗线耳仔筒  
**用机:** 单针平车  
**Purpose:** Make spaghetti like tube  
**Machine:** 1 needle lockstitch machine

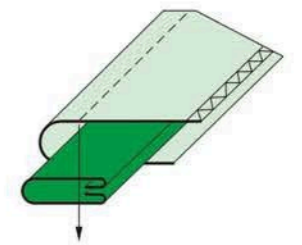

尺寸 Size	mm	5	6	7	8	10	12
------------	----	---	---	---	---	----	----

**FD-272** 塑料细条仔  
ELASTIC STRAP FOLDER



**作用:** 包边  
**用机:** 单针平车  
**Purpose:** Binding  
**Machine:** 1 needle machine

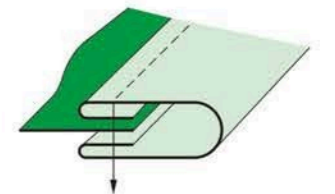

**FD-273** 辘轳裤脚筒  
JEANS BOTTOM HEMMING FOLDER



**作用:** 车牛仔裤脚用  
**用机:** 迂仁辘脚车  
**Purpose:** Circular hemming of jeans bottom  
**Machine:** Union special bottom hemming machine



标准厚度 Standard Thickness	XH	H	尺寸可调 Size Adjustable	寸 Inch	1/2~1
----------------------------	----	---	-------------------------	-----------	-------

**FD-274** 绳子筒  
PIPING FOLDER



**作用:** 车捆条连绳仔, 用于睡衣, 枕头袋等  
**用机:** 单针平车  
**Purpose:** Attach piping with sting e.g. pajama and pillow case  
**Machine:** 1 needle machine

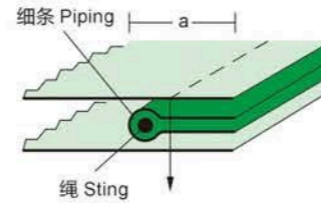

**FD-276** 恤衫明筒/右手  
TOP CENTER PLAIT FOLDER / RIGHT



**作用:** 男女衫前胸明筒-有朴  
**用机:** 2或4针车  
**Purpose:** Top center plait of shirt and blouse-with lining  
**Machine:** 2 or 4 needle machine

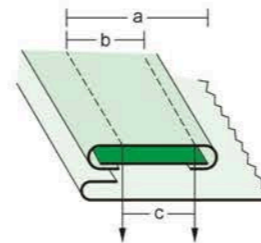

尺寸 Size	a	7/8	1	1-1/8	1-3/16	1-1/4	1-3/8	1-1/2	1-5/8	1-3/4
	b	3/8			1/2					
寸 Inch	c	5/8-3/4	5/8-7/8	5/8-1	11/16-1-1/8	3/4-1-1/8	7/8-1-1/4	1-1-3/8	1-1/8-1-1/2	1-1/4-1-5/8
	入口IN	1-5/8	1-3/4	1-7/8	2-3/16	2-1/4	2-3/8	2-1/2	2-5/8	2-3/4

**FD-277** 多针车绳子筒  
MULTI PIPING ATTACHMENT



**尺寸:** 定制  
**Size:** Customize

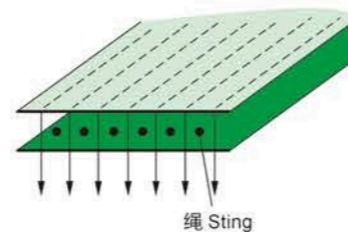

**FD-278** 暗筒折边器  
COVER PLACKET HEMMER

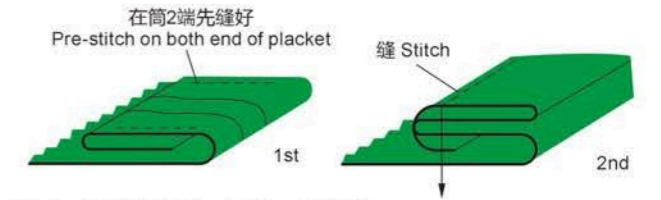

**作用:** 女衫前胸暗筒  
**用机:** 单针平车  
**Purpose:** Lady blouse cover placket  
**Machine:** 1 needle lockstitch machine

标准厚度 Standard Thickness	M	MH							
尺寸 Size	寸 Inch	7/8	1	1-1/8	1-3/16	1-1/4	1-3/8	1-1/2	

**FD-279** 纽仔筒有朴  
PLAIT FOLDER WITH INTER LINING



**作用:** 男女恤纽仔-有朴  
**用机:** 单针平车  
**Purpose:** Button plait with interlining  
**Machine:** 1 needle lockstitch machine

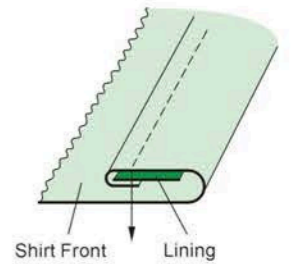

出口 Finished Size	寸 Inch	3/4	7/8	1	1-1/8	1-1/4	1-3/8	1-1/2
---------------------	-----------	-----	-----	---	-------	-------	-------	-------

**FD-280** 恤衫明筒  
TOP CENTER PLAIT FOLDER



**作用:** 男女衫前胸明筒-有朴  
**用机:** 2或4针车  
**Purpose:** Top center plait of shirt and blouse-with lining  
**Machine:** 2 or 4 needle machine

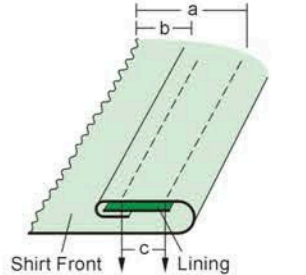

尺寸 Size	a	7/8	1	1-1/8	1-3/16	1-1/4	1-3/8	1-1/2	1-5/8	1-3/4
	b	1/2								
寸 Inch	c	1/2-3/4	1/2-7/8	5/8-1	11/16-1-1/8	3/4-1-1/8	7/8-1-1/4	1-1-3/8	1-1/8-1-1/2	1-1/4-1-5/8

**FD-281** 银箭绳子筒  
SIRUBA PIPING FOLDER



**作用:** 车捆条连绳仔, 用于睡衣, 枕头袋等  
**用机:** 银箭车  
**Purpose:** Attach piping with sting e.g. pajama and pillow case  
**Machine:** SIRUBA lockstitch machine

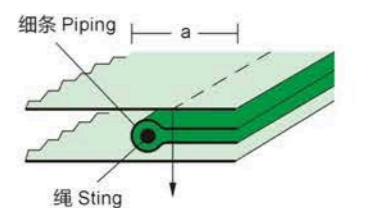

**FD-283** 绳子筒  
PIPING ATTACHMENT



作用：车细条连绳仔  
用机：单针平车  
Purpose:  
Attach piping  
Machine:  
1-needle lockstitch machine

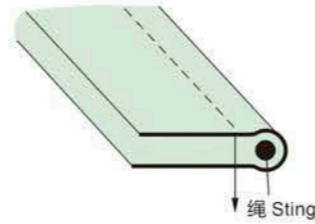

**FD-284** 包边筒  
FOLDER



尺寸：定制  
Size: Customize

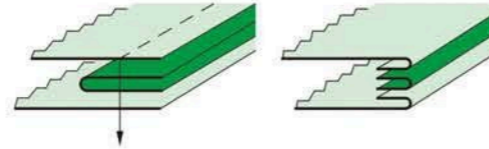

入口 Tape Size	mm	20	25	30	35	40	45	50
-----------------	----	----	----	----	----	----	----	----

**FD-285** 包边筒  
FOLDER



尺寸：定制  
Size: Customize

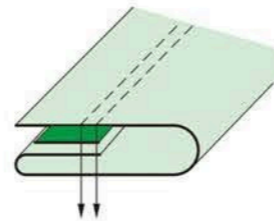

入口 Tape Size	mm	30	38	45	50	55	60
出口 Finished Size	mm	10	12	15	17	18	20

**FD-286** 包边筒  
FOLDER



尺寸：定制  
Size: Customize

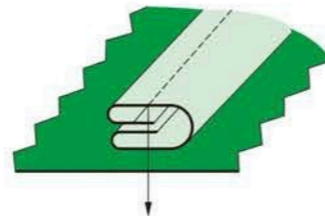

出口 Finished Size	mm	20	25	30
---------------------	----	----	----	----

**FD-287** 包边筒  
FOLDER



尺寸：定制  
Size: Customize

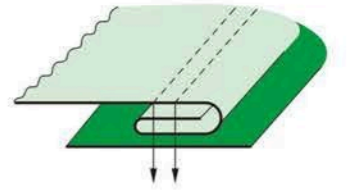

出口 Finished Size	mm	20	25	30
---------------------	----	----	----	----

**FD-288** 折袖拉筒  
OPEN ABLE TOP SWING HEMMER



作用：圆桶式短袖或折边用  
用机：单针平车  
Purpose:  
Circular hemming of shirt  
sleeve or bottom  
Machine:  
1 needle lockstitch machine

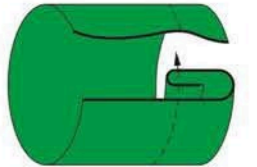

**FD-289** 双针埋夹筒  
LAP SEAM FOLDER FOR DOUBLE NEEDLE MACHINE



作用：缝薄布或恤衫后幅  
用机：双针上袖车  
Purpose:  
Back seam of shirt or  
light weight fabric  
Machine:  
2 needle machine

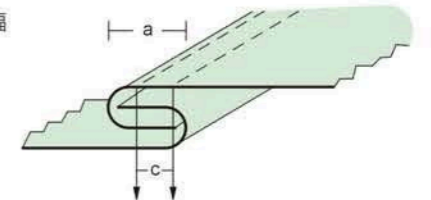

**FD-290** 双针车折边器  
SINGLE DOWN-TURN FOLDER FOR DOUBLE NEEDLE



作用：拉针线T恤领、袖等  
用机：双针车  
Purpose:  
Binding of knitwear collar  
and sleeve  
Machine:  
Double needle machine

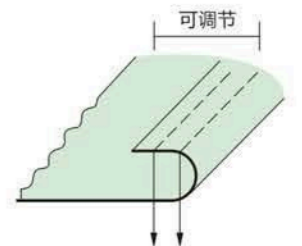

**FD-291** 包边筒  
BINDER



尺寸：定制  
Size: Customize

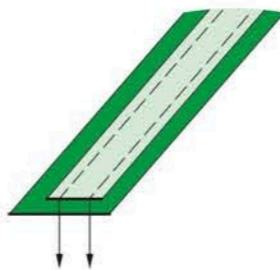

**FD-292** 包边筒  
BINDER



尺寸：定制  
Size: Customize

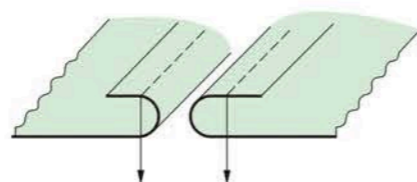

**FD-294** 领拉筒  
COLLAR TAPE ATTACHMENT



作用：原身布车T恤领贴  
用机：3、4线级骨车  
Purpose: Sew polo shirt collar tape by original fabrics  
Machine: 3 or 4 thread overlock machine

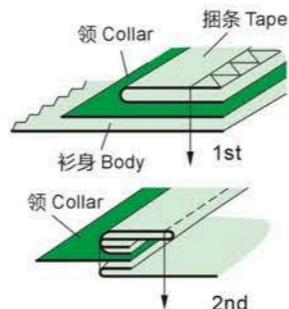

标准厚度 Standard Thickness		MH	H													
出口 a Finished Size	寸 Inch	3/8		出口 Finished Size	寸 Inch	5/8	3/4	7/8	1	1-1/8	1-1/4	1-3/8				
入口 Tape Size	寸 Inch	3/8		入口 Tape Size	寸 Inch	1-1/4	1-1/2	1-3/4	2	2-1/4	2-1/2	2-3/4				

**FD-295** 领拉筒  
COLLAR TAPE ATTACHMENT



作用：用织带车T恤领贴  
用机：3、4线级骨车  
Purpose: Sew polo shirt collar by tape  
Machine: 3, 4 thread overlock machine

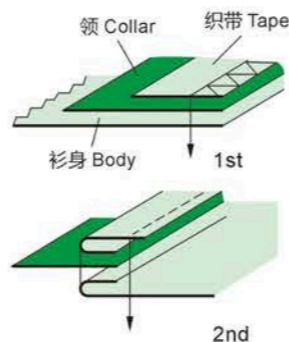

标准厚度 Standard Thickness		MH	H			
尺寸 Size	寸 Inch	1/2	5/8	3/4		

**FD-303** 三尖侧贴筒  
TRIANGULAR SLEEVE PLACKET FOLDER



作用：折三尖侧贴  
用机：热压辊机  
Purpose: Fold triangular sleeve placket  
Machine: Hot roll machine

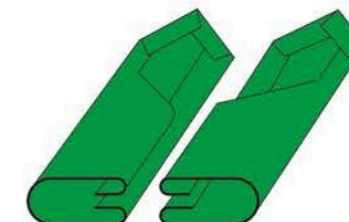

**FD-304** 平车靴头筒  
LOOP FOLDER FOOT



作用：车耳仔  
用机：单针平车  
Purpose: Loop sewing  
Machine: 1 needle lockstitch machine

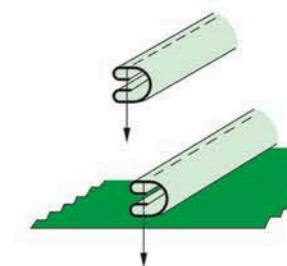

标准厚度 Standard Thickness		M	MH	
出口 a Finished Size	寸 Inches	1/8	3/16	1/4
入口 Tape Size	寸 Inches	1/2	3/4	1

**FD-305** 双针花边袖贴筒  
LACE SLEEVE FACING FOLDER



作用：双针女袖袖底贴  
用机：双针车  
Purpose: Lady sleeve bottom plait  
Machine: 2 needle machine

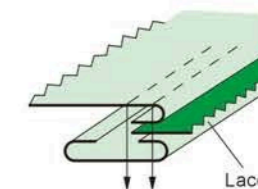

标准厚度 Standard Thickness		M	MH	
针距 c Finished Size	寸 Inches	1/4	3/8	
出口 a Finished Size	寸 Inches	3/8	1/2	

**FD-306** 折袖拉筒  
OPEN ABLE TOP SWING HEMMER



作用：圆桶式短袖或折边用  
用机：单针平车  
Purpose: Circular hemming of shirt sleeve or bottom  
Machine: 1 needle lockstitch machine



**FD-307** 耳仔筒  
BEIT LOOP FOLDER



作用：耳仔筒  
用机：双针耳仔车  
Purpose:  
Belt loop  
Machine:  
2 needle belt

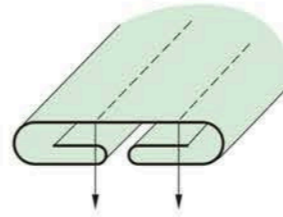

尺寸 Size	a	3/8	1/2	5/8	3/4	7/8	1
寸 Inch	入口IN	7/8	1-1/8	1-3/8	1-5/8	1-3/4	2
	c	1-4					

**FD-308** 工字折边器  
SEW BOX PLEAT



作用：车工字折边器  
用机：双针平车  
Purpose:  
Sew box pleat  
Machine:  
2 needle machine

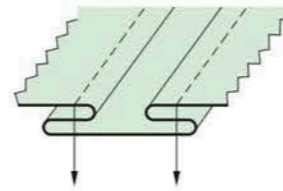

尺寸 Size	寸 Inches	1/2	5/8	3/4	7/8	1	1-1/8
------------	-------------	-----	-----	-----	-----	---	-------

**FD-309** 假反明筒  
IMMIATION SLEEVE FOLDER



作用：男女衫前胸明筒一有朴  
用机：2或4针筒车  
Purpose:  
Top centet plait of shirt and blouse-with lining  
Machine:  
2 or 4 needle machine

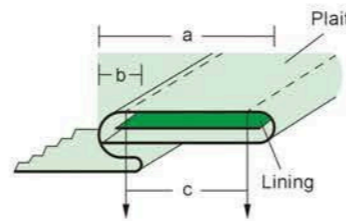

尺寸 Size	a	1	1-1/8	1-3-16	1-1/4	1-3/8	1-1/2
寸 Inch	b	1/4 5/16	1/4 1/16	1/4 5/16	1/4 5/16	1/4 5/16	1/4 5/16
	c	5/8 1/2	3/4 5/8	13/16 11/16	7/8 3/4	1 1/8	1-1/8 1

**FD-410** 超声波导带器  
TAPE GUIDE FOR ULTRASONIC



尺寸：定制  
Size: Customize

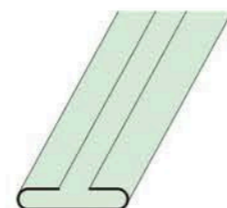

**FD-411** 暗线打折筒  
PIN TUCK ATTACHMENT



作用：暗线打折  
用机：单针平车  
Purpose:  
Sew pin tuck  
Machine:  
1 needle machine

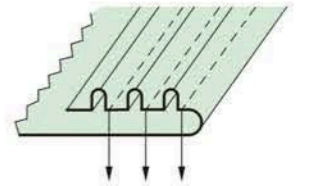

**FD-412** 上下两层筒  
TWO PLECE BELT LOOP FOLDER



作用：皮革拉带  
用机：双针机  
Purpose:  
Belt for leather  
Machine:  
2-needle machine

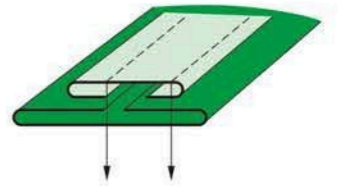

**FD-413** 领贴筒  
COLLAR TAPE FOLDER



作用：拉针织T恤领贴  
用机：2或3针车  
Purpose:  
Binder of knitwear collar tape  
Machine:  
2 or 3 needle machine

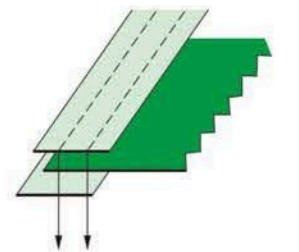

**FD-414** 拉链包边缝  
ZIPPER FOLDER



尺寸：定制  
Size: Customize

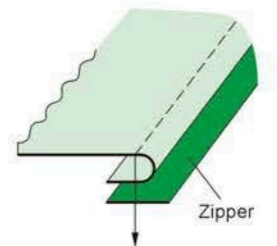

**FD-415** 包边筒  
BINDER



尺寸：定制  
Size: Customize

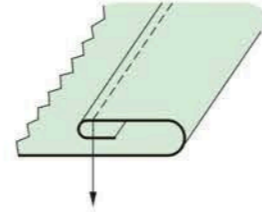

出口 Finished Size	mm	50	60	70	80	90	100
---------------------	----	----	----	----	----	----	-----

**FD-416** 日字埋夹筒  
SIDE SEAM FOLDER-JAPAN STYLE



作用：薄布埋夹用  
用机：日本2、3针埋夹车  
Purpose: Sew side seam of light weight fabric  
Machine: Japan made 2, 3 needle feed of arm machine

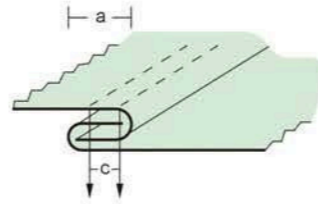

尺寸 Size	a	3/16	5/16	3/8
寸 Inch	c	1/8	3/16	1/4

**FD-417** 高头车拉筒 (鞋口)  
BINDER FOR POSTBED MACHINE



作用：包鞋口边  
用机：高头车  
Purpose: Closed shoe uppers  
Machine: Postbed machine

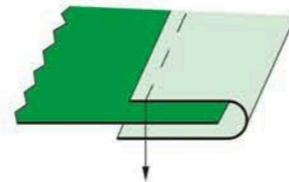

**FD-418** 领贴筒  
COLLAR TAPE FOLDER



作用：拉针织T恤领贴  
用机：2或3针车  
Purpose: Binder of knitwear  
Machine: 2 or 3 needle machine

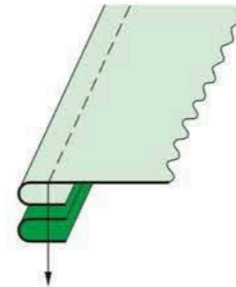

**FD-419** 西裤裤头拉筒  
BINDER FOR TROUSERS PANTS



尺寸：定制  
Size: Customize

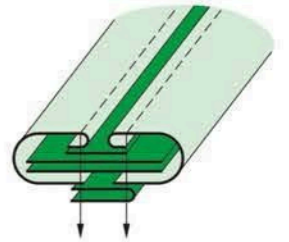

**FD-420** 折脚拉筒  
HEMMING



作用：衬袖口袋折边  
用机：单针平车  
Purpose: Hemming for shirt pocket  
Machine: 1 needle machine

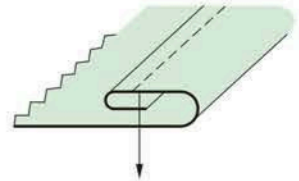

尺寸 Size	寸 Inches	3/4	7/8	1	1-1/8	1-1/4	1-3/8	1-1/2
------------	-------------	-----	-----	---	-------	-------	-------	-------

**FD-421** 捆条拉脚筒  
SWING HEMMER WITH PIPING



作用：原身包橡筋裤头  
用机：2、3、4针橡筋车  
Purpose: Hemming waist band with elastic-loose bottom  
Machine: 2, 3, 4 needle elastic machine

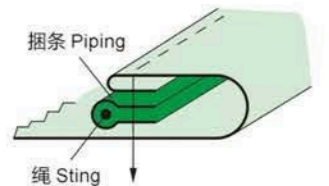

标准厚度 Standard Thickness	M	MH
----------------------------	---	----

尺寸 Size	寸 Inch	1/2	5/8	3/4	7/8	1	1-1/8	1-1/4	1-3/8	1-1/2	1-5/8	1-3/4	捆条	3/4	3/8
------------	-----------	-----	-----	-----	-----	---	-------	-------	-------	-------	-------	-------	----	-----	-----

**FD-422** 单针纳膊筒  
SINGLE NEEDLE SHOULDER TOP STITCH ATTACHMENT



作用：单针明线缝撑杆及后幅  
用机：单针平车  
Purpose: Single needle top stitch attach of yoke to of yoke to back shirt  
Machine: 1 needle lockstitch machine

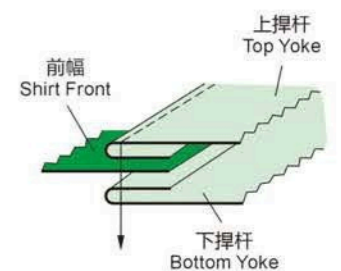

标准厚度 Standard Thickness	M	MH
----------------------------	---	----

出口 Finished Size	a	寸 Inches	3/8
入口 Tape Size	寸 Inches	3/8	

**FD-423** 耳仔筒  
BEIT LOOP FOLDER



作用：耳仔筒  
用机：双针耳仔车  
Purpose:  
Belt loop  
Machine:  
2 needle belt

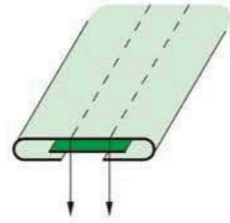

尺寸 Size	a	3/8	1/2	5/8	3/4	7/8	1
寸 Inch	入口IN	7/8	1-1/8	1-3/8	1-5/8	1-3/4	2
	c	1-4					

**FD-424** 箱包拉筒  
BINDER FOR UNSION FEED MACHINE



作用：箱包，鞋  
用机：同步车  
Purpose:  
Bags, shoes  
Machine:  
Synchronous machine

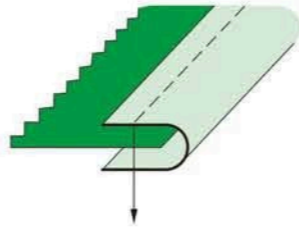

入口 Tape Size	mm	12	15	18	20	25	30	35
出口 Finished Size	mm	6.5	7.5	9	10	12.5	15	17.5

**FD-425** 耳仔筒  
BEIT LOOP FOLDER



作用：耳仔筒  
用机：双针耳仔车  
Purpose:  
Belt loop  
Machine:  
2 needle belt

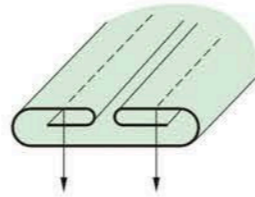

尺寸 Size	a	3/8	1/2	5/8	3/4	7/8	1
寸 Inch	入口IN	7/8	1-1/8	1-3/8	1-5/8	1-3/4	2
	c	1-4					

**FD-426** 箱包提手包边筒  
LEATHER WAIS BAND FOLDER WITH SINGLE PIPING



尺寸：定制  
Size: Customize

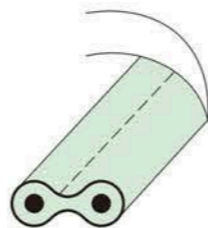

**FD-427** 日字埋夹落朴筒  
SIDE SEAM FOLDER WITH LINING-JAPAN STYLE



作用：薄布埋夹用  
用机：日本2、3针埋夹车  
Purpose:  
Sew side seam of light weight fabric  
Machine:  
Japan made 2, 3 needle feed of arm machine

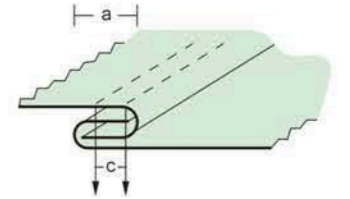

尺寸 Size	a	3/16	5/16	3/8
寸 Inch	c	1/8	3/16	1/4

**FD-428** 拉链包边筒  
ZIPPER FOLDER



尺寸：定制  
Size: Customize

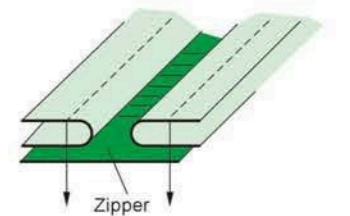

**FD-429** 运动衫侧袖筒  
JERSEY SIDE SLEEVE FOLDER



尺寸：定制  
Size: Customize

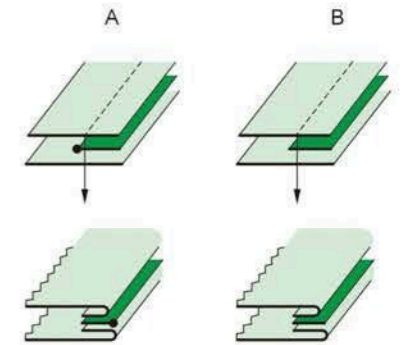

**FD-430** 叠位筒  
JOINING GUIDE



作用：缝接针织裁片如T恤肩袖等  
用机：2或3针车  
Purpose:  
Joining of knit piece eg. shoulder and sleeve of T shirt  
Machine:  
2 or 3 needle machine

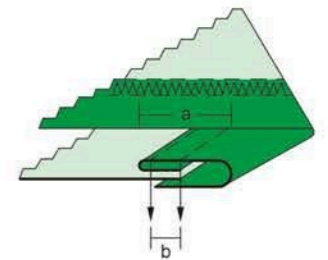

出口 Finished Size	a	1/4	5/16	3/8	1/2	5/8	3/4	7/8	1
入口 Tape Size	寸 Inches	3/4	15/16	1-1/8	1-3/8	1-5/8	1-7/8	2-1/8	2-3/8

**FD-431** 领贴筒  
COLLAR TAPE FOLDER



**作用:** 拉针织T恤领贴  
**用机:** 2或3针车  
**Purpose:** Binder of knitwear collar tape  
**Machine:** 2 or 3 needle machine

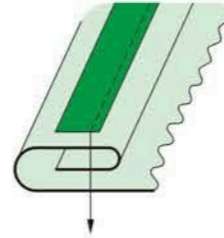

**FD-432** 导带器  
TAPE GUIDE



**尺寸:** 定制  
**Size:** Customize

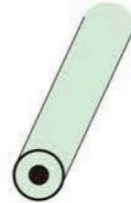

**FD-433** 高头车拉筒 (鞋口)  
BINDER FOR POSTBED



**作用:** 包鞋口边  
**用机:** 高头车  
**Purpose:** Closed shoes uppers  
**Machine:** Postbed machine

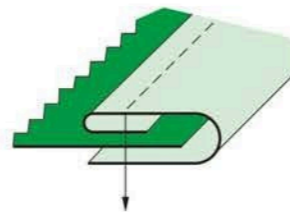

**FD-434** 双针带朴贴条筒



**作用:** 车双针面贴  
**用机:** 双针车  
**Purpose:** Attach tape on top of fabric surface e.g. jogging suit  
**Machine:** 2 needle machine

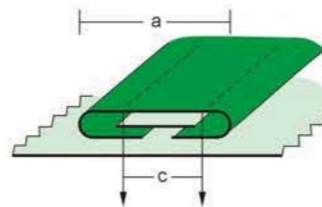

尺寸 Size	a	3/8	1/2	5/8	3/4	7/8	1	1-1/8
寸 Inches	c	1/4	3/8	1/2	5/8	3/4	7/8	1
	入口IN	7/8	1-1/8	1-3/8	1-1/2	1-5/8	1-3/4	1-7/8

**FD-435** 绳子筒  
PIPING FOLDER



**作用:** 车捆条连绳仔, 用于睡衣, 枕头袋等  
**用机:** 单针平车  
**Purpose:** Attach piping with sting e.g. pajama and pillow case  
**Machine:** 1-needle lockstitch machine

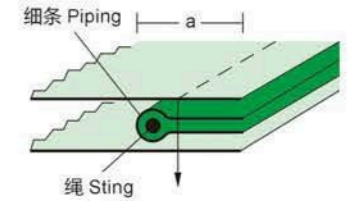

尺寸 Size	a	3/8	7/16	1/2	5/8
寸 Inches	入口IN	3/4	7/8	1	1-1/4
	绳 Sting	1/16~1/8		3/16	

**FD-436** 单折包边筒  
SINGLE FOLD EDGE BINDER



**作用:** 布衣  
**用机:** 双针平车  
**Purpose:** Edge binder (Plastic)  
**Machine:** 2-needle lockstitch machine

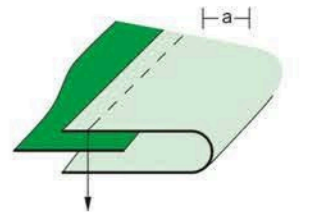

尺寸 Size	a	3/8	7/16	1/2
寸 Inch	入口IN	3/4	7/8	1

**FD-437** 领贴筒  
COLLAR TAPE FOLDER



**作用:** 拉针织T恤领贴  
**用机:** 2或3针车  
**Purpose:** Binder of knitwear collar tape  
**Machine:** 2 or 3 needle machine

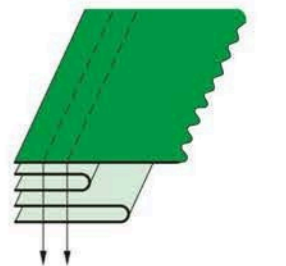

**FD-438** 草席包边筒  
GRASSMAT FOLDER



**尺寸:** 定制  
**Size:** Customize

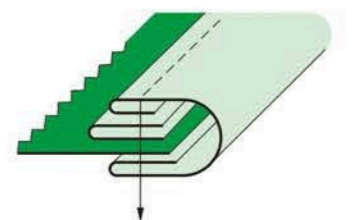

HOOKS  
旋梭系列



7.24mm



**UN-Z16/HOOK DB1-Z16**

FOR: BROTHER LE2-B861-1  
JUKI LZ-27,29,40,271,403  
MEIJA G15-2  
ADLER 199,289,489  
CONSEW 133A.825  
SUNSTAR KLZ-371  
UNICORN LZ2-H272

7.94mm



**UN-7.94A/HOOK HSH-7.94A**

FOR: BROTHER DB2-B706-5,B714-5,  
B755-5  
JANOME DB-J705,706  
MITSUBISHI DB-130-12,13,  
130G-12,130G-127,DY-340-12  
SINGER 391U,400W,402W,451K  
NITAKA TC-1553,1555  
NAKAJIMA DSN178-3

7.94mm



**UN-7.94A(T)/HOOK HSH-7.94A(T)**

FOR: BROTHER DB2-B706-5,B714-5,  
B755-5  
JANOME DB-J705,706  
MITSUBISHI DB-130-12,13,  
130G-12,130G-127,DY-340-12  
SINGER 391U,400W,402W,451K  
NITAKA TC-1553,1555  
NAKAJIMA DSN178-3

7.94mm



**UN-7.94A(MTQTS)/HOOK HSH-7.94A(MTQTS)**

FOR: BROTHER DB2-B706-5,B714-5,  
B755-5  
JANOME DB-J705,706  
MITSUBISHI DB-130-12,13,  
130G-12,130G-127,DY-340-12  
SINGER 391U,400W,402W,451K  
NITAKA TC-1553,1555  
NAKAJIMA DSN178-3

7.94mm



**UN-7.94B/HOOK HSH-7.94B**

FOR: BROTHER DB2-B714-3,B753,  
B795-013  
JUKI DDL-127,227,541,555,5550  
MITSUBISHI DB-126-10,130G-10,  
171,LS2-1130-M,MOB-150-MOB  
SINGER 281-81,83,366,400W,  
600W  
TOYOTA AD148,156,345,352,  
D146,347,352  
JANOME DB-J701~4,J707~8

7.94mm



**UN-7.94B(T)/HOOK HSH-7.94B(T)**

FOR: BROTHER DB2-B714-3,B753,  
B795-013  
JUKI DDL-127,227,541,555,5550  
MITSUBISHI DB-126-10,130G-10,  
171,LS2-1130-M,MOB-150-MOB  
SINGER 281-81,83,366,400W,  
600W  
TOYOTA AD148,156,345,352,  
D146,347,352  
JANOME DB-J701~4,J707~8

7.94mm



**UN-7.94ATR/HOOK HSH-7.94ATR**

FOR: ABLE HB-300  
CHUAN NENG CN-991,992

7.94mm



**UN-7.94BTR/HOOK HSH-7.94BTR**

FOR: JANOME DB-J709  
JUKI DDL-500,DL-432-2,  
DMN-530  
TOYOTA AD157-623-666,  
AD157A-622  
CONSEW 290RATCW,290RTC,  
290RTCW  
ABLE HBS-2700  
SUNSTAR KM-235A  
NAKAJIMA 178Y-2

7.94mm



**UN-7.94BTR(MTQTS)/HOOK HSH-7.94BTR(MTQTS)**

FOR: JANOME DB-J709  
JUKI DDL-500,DL-432-2,  
DMN-530  
TOYOTA AD157-623-666,  
AD157A-622  
CONSEW 290RATCW,290RTC,  
290RTCW  
ABLE HBS-2700  
SUNSTAR KM-235A  
NAKAJIMA 178Y-2

7.94mm



**UN-6-5/HOOK HSM-B1H**

FOR: BROTHER DB2-B745-5  
JUKI DDL-201H  
MITSUBISHI DY330-22D,337-2S  
ABLE HB-380

7.94mm



**UN-6-5(T)/HOOK HSM-B1H(T)**

FOR: BROTHER DB2-B745-5  
JUKI DDL-201H  
MITSUBISHI DY330-22D,337-2S  
ABLE HB-380

7.94mm



**UN-2603/HOOK GC2603**

FOR: TYPICAL GC 2603,GC 2605

7.93mm



**UN-LH(2280)/HOOK LH-2280**

FOR: JUKI LZ-2280,2285

7.93mm



**UN-LB(814)/HOOK DP2-LB**

FOR: BROTHER LH-B814-2,3,4,102

# TOPDIS

## HOOKS 旋梭系列

7.93mm

### UN-LH(781)/HOOK DP2-NJ771



FOR: JUKI LBH-771~774,781~784  
K-CHANCE KBH-890  
TAKING TK-888  
DALIAN G18

7.94mm

### UN-761/HOOK DP2-NJ



FOR: JUKI LBH-761,762,763  
DALIAN G13  
HUANAN(SOUTH CHINA) G16-1  
SHANGGONG G15  
SUNGOOD GF11001

7.94mm

### UN-815/HOOK DP2-815



FOR: BROTHER LH4-B815  
BAS-500

7.94mm

### UN-NJ(790)/HOOK DP2-NG(790)



FOR: JUKI LBH-1700,1790S,  
791S~794S

7.94mm

### UN-2290/HOOK 2290



FOR: JUKI LZ-2282N-7,2284N-7

7.24mm

### UN-335(5)/HOOK HPF-335(5)



FOR: SEIKO LSC-8B, 8BV  
CONSEW 277R,277RFS

7.93mm

### UN-820/HOOK HSH-31(6)



FOR: YAKUMO 981,982  
GOLDEN WHEEL CS-810,820  
NITAKA TC-810S,820C  
SUNSTAR KM-867,KPW-827B

9.52mm

### UN-831L/HOOK HSH-12-15L



FOR: BROTHER LT2-831-1,3B832-1,  
3B833  
SEIKO LTW-26,27,27B,27BM  
NITAKA TC2-B842  
SUNSTAR KM2-740B

9.52mm

### UN-842/HOOK HG12-15L(TRI)



FOR: BROTHER LT2-B842

9.52mm

### UN-845/HOOK HG12-15LC



FOR: BROHTER LT2-B845

9.52mm

### UN-265/HOOK HSH-12-155MM



FOR: MITSUBISHI DB-286,286-10,260,  
260-7,260-10,265,265-10,  
LT2-220-M,220-MOB  
TYPICAL 20201  
UNICORN LT2-H320,H321  
HIGHLEAD GC20518M

9.52mm

### UN-275/HOOK HSH-12MC



FOR: MITSUNBISHI DN-275-10,10K  
TYPICAL 20202  
HIGHLEAD GC20528M

9.52mm

### UN-872/HOOK HG12(BR)



FOR: BROTHER LT2-B872  
GEMSY 872  
JACK JK5872-5  
TYPICAL GC6872H, GC6872M  
ZOJE 872  
SIRUBA T828-72-HL,T828-72-ML

9.52mm

### UN-875/HOOK HG12MC(1)



FOR: BROTHER LT2-B875  
GEMSY 875  
JACK JK5875-3  
TYPICAL GC6875H, GC6875M

# TOPDIS

## BOBBIN CASES & CAPS 梭芯套系列

### BC-DB1



FOR: ADER. BROTHER. CONSEW.  
HUSQVARNA. JANOME. JUKI.  
MITSUBISHI. NECCHI. RICCAR.  
TOYOTA. YAKUMO. YASIMA.  
SINGER  
95.96.103.188U.195K.196K.245.  
TOYOTA. YAKUMO. YASIMA.

52237

### BC-DB1-NBL1



FOR: ADER. BROTHER. CONSEW.  
HUSQVARNA. JANOME. JUKI.  
MITSUBISHI. NECCHI. RICCAR.  
TOYOTA. YAKUMO. YASIMA.  
SINGER  
95.96.103.188U.195K.196K.245.  
TOYOTA. YAKUMO. YASIMA.

52237NBL1

### BC-DBZ(1)



FOR: ADLER 199.289.489.  
BARUDAN. BROTHER. TZ1.LE2.  
JUKI LZ(except -405,407,-581,  
-583,-586,-1280,-1286,-1287)  
NECCHI 533.535.720.721  
STAGER DZ.SZ(except DZ-S31,  
SZ-21-1B,-5,-310)

117596-001 B1837-027-OAO

### BC-DBZ(1)-NBL6HS



FOR: ADLER 199.289.489.  
BARUDAN. BROTHER. TZ1.LE2.  
JUKI LZ(except -405,407,-581,  
-583,-586,-1280,-1286,-1287)  
NECCHI 533.535.720.721  
STAGER DZ.SZ(except DZ-S31,  
SZ-21-1B,-5,-310)

117596-001 B1837-027-OAO

### BC-DBZ(1)-NBL6



FOR: ADLER 199.289.489.  
BARUDAN. BROTHER. TZ1.LE2.  
JUKI LZ(except -405,407,-581,  
-583,-586,-1280,-1286,-1287)  
NECCHI 533.535.720.721  
STAGER DZ.SZ(except DZ-S31,  
SZ-21-1B,-5,-310)

117596-001 B1837-027-OAO

### BC-DBM(1)-NBL1



FOR: BROTHER. CONSEW. JANOME.  
JUKI. MITSUBISHI. SINGER.  
TOYOTA. TREASURE. YAKUMO.  
TASIMA

### BC-DBM(1)



FOR: BROTHER. CONSEW. JANOME.  
JUKI. MITSUBISHI. SINGER.  
TOYOTA. TREASURE. YAKUMO.  
TASIMA

### BC-6-5 NBL



FOR: GC6-5 series

### BC-6-5



FOR: GC6-5 series

### BC-DBM(22)-NBL



FOR: TAJIMA.

### BC-DB1-2-NBL1



### BC-DB1-H



### BC-DB1-2



### BC-DB(2)-TM



# TOPDIS

## BOBBIN CASES & CAPS 梭芯套系列



**BC-LK(J3)**

FOR: **JUKI** LK-280,-291,-980,  
LK-981,-982,-987,

B1828-980-OAO



**BC-LK(J)-NBL**

FOR: **JUKI** LK-232,-237,-239,-322

B1836-232-OAO



**CP-G12C**

FOR: **BROTHER** LT2-B845  
**SUNSTAR** KM-490

S07741-001



**CP-12C**

FOR: **BROTHER** LT2-B835-3,5,800  
**JUKI** LH-528  
**MITSUBISHI** DN-275-10,10K  
**SEIKO** LTW-278K  
**ONSEW** 327R-1, **ABLE** HB-630  
**GOLDEN WHEEL** CS-875-3,5,3150-3,5  
**NITAKA** TC2-B845  
**SICAMA(TASICO)** LT2-B845  
**UNICORN** LT2-H240-MOB  
**UNION SPECIAL** 6L200  
B1837-528-OAO 16291-06

**CP-62C**

FOR: **JUKI** LH-1182, 1182-4,5  
**SICAMA(TASICO)** SC-1182-5,6

102-08254



**BC-DBZ(2)**

FOR: **JUKI** LZ-586

B1837-586-OAO



**SC-205H**

FOR: **JUKI** AMS220

B1828-205-OAA



**BC-LK(B2)**

FOR: **BROTHER** LK3-B430,-B436,  
LK3-B438,  
BAS-303~236  
LK3-BAS-555

152688-101



**CP-12(2)**

FOR: **JUKI** LH1152,1152-5

101-10252



**CP-M82C**

FOR: **JUKI** LH-1182, 1182-4,5  
**SICAMA(TASICO)** SC-1182-5,6  
**SHANGGONG** GD 8-7

102-31553



**CP-HPF341**

FOR: **PFAFF** 144  
**GOLDEN WHEEL** CS-61118.T.BT  
CS-61128.T.BT  
**SEIKO** PWB-8GWC, F.LLC  
**SUNSTRA** KM-867-7

**BC-PF151**

FOR: **PFAFF** 120cl,122cl,145cl,146cl,  
151cl,155cl  
**YASHIMA** LF-12,-103,-224,-225  
-226, LT2-YX

10159



**BC-310A**

FOR: **BROTHER** BAS.-304 30.311.314  
326.341.701

S15902-201



**SC-181**

FOR: **MITSUBISHI** PLK-A1710

AD190D411PO3

# TOPDIS

## BOBBIN CASES & CAPS 梭芯套系列



**BC-LBH771**

FOR: **JUKI** LH-771~774,781~784

B1810-771-OAO



**BC-DP2(3B)**

FOR: **BROTHER** LH4-B814



**BC-107(2)**

FOR: **JUKI** LBH-761,762,763  
**MITSUBISHI** LZ-710-11,760-11,11-D  
**SINGER** 107G,107W3,14,15,50,143W1,2  
3,18,151K,151W,307G2,150W  
**ADLER** 91,98  
**ONSEW** 275,276  
**DURKOPP** 252~255,264  
**YAMATO** DP2,DP3

B1810-761-OAO 224441/241404



**BC-2280**

FOR: **JUKI** LZ-2280

100-34056



**BC950**



**10355**



**BC-PF9076(14)**

FOR: **PFAFF** 130, 138, 230, 238, 335  
**SEIKE** LDC



**BC-457(NS)**

FOR: **ONSEW** 347,375R,376R  
**JUKI** LZ-1280,-1286,-1287  
**MITSUBISHI** LZ-720-11  
**BROTHER** LZ2  
**SINGER** 457G,457U  
**STAGER** DL-S31,SZ-310  
**TOYOTA** AD550, A551

502530NBL



**BC-107(2)NBL**

FOR: **JUKI** LBH-761,762,763  
**MITSUBISHI** LZ-710-11,760-11,11-D  
**SINGER** 107G,107W3,14,15,50,143W1,2  
3,18,151K,151W,307G2,150W  
**ADLER** 91,98  
**ONSEW** 275,276  
**DURKOPP** 252~255,264  
**YAMATO** DP2,DP3  
**BROTHER** DL1-B812,B813,LH4-B814-2~5  
B815,LZ1-B851  
224441NBL 143986-101

224441NBL 143986-101



**15277B**



**BC-HR221**



**172082-B**



**BC-DBZ(3)**

FOR: **ETLTAC** 750 series  
**SINGER** 20U  
**TAJIMA**

541678/410025



**83500 84505**

DESHENG HOOK 德盛旋梭



规格表 / SPECIFICATION

名称 Name	型号 Model	规格 Specifications
高速缝梭头 High speed	DSH-7.94A	Φ7.94
	DSH-7.94A1	Φ7.94
	DSH-7.94A(TS)	Φ7.94
	DSH-7.94A(T)	Φ7.94
	DSH-7.94B	Φ7.94
	DSH-7.94B(TS)	Φ7.94
	DSH-7.94B(T)	Φ7.94
	DSH-7.94B(2SPH)	Φ7.94
	DSH-7.94C	Φ7.94
	DSH-7.94C(TS)	Φ7.94
	DSH-7.94CO	Φ7.94
	DSH-7.94BRN	Φ7.94
	DSH-7.94BRNH	Φ7.94
	DSH-7.94BD	Φ7.94
	DSH-7.94BOH	Φ7.94
	DSH-8.00B	Φ8.00
DSH-614B	Φ8.10	
自动切线梭头 Auto trimmer	DSH-7.94ATR	Φ7.94
	DSH-7.94BTR	Φ7.94
	DSH-7.94BTR(TS)	Φ7.94
	DSH-7.94BTR(T)	Φ7.94
	DSH-7.94BTR(SPH)	Φ7.94
	DSH-7.94BTR(3)	Φ7.94
	DSH-BTR(HPNG)	Φ7.94
	DSH-2628	Φ7.94
	DSH-7.94BOHNTR	Φ7.94

规格表 / SPECIFICATION

名称 Name	型号 Model	规格 Specifications
自动切线梭头 Auto trimmer	DSH-BHTR	Φ7.94
	DSH-7.94BTRQ	Φ7.94
多头绣花梭头 Multi-head embroidery	DSH-7.94A(MTQ)	Φ7.94
	DSH-7.94A(MTQTS)	Φ7.94
	DSH-7.94ATR(MTQ)	Φ7.94
	DSH-7.94ATR(MTQTS)	Φ7.94
	DSH-7.94A(MTQJ)	Φ7.94
	DSH-7.94ATR(MTQJ)	Φ7.94
	DSH2-A(MQTS)	Φ7.94
	DSH2-A(MQ)	Φ7.94
	DSH2-ATR(MTQTS)	Φ7.94
	DSH2-ATR(MTQ)	Φ7.94
垂直大型梭头 Vertical large	DSH2-ATR(PFNGOPTS)L	Φ7.94
	DSH2-B1H(6-5)	Φ7.94
	DSH2-GC(6-10)	Φ7.94
	DSH2-GC6-10TR	Φ7.94
	DSH2-A1(6-7)	Φ7.94
	DSH2-GC-L(6-7)	Φ7.94
	DSH2-GC(2603)	Φ7.94
	DSH2-GC(6-20)	Φ7.94
	DSH2-B(Q)TR	Φ7.94
	DSH2-ATR(1Q)	Φ7.94
特殊梭头水平型 Horizontal special type	DSH2-241	Φ7.94
	DSH2-B(Z17)	Φ7.94
	DSH2-467TR	Φ10.0
	DSH2-GC(6-30)	Φ7.94

规格表 / SPECIFICATION

名称 Name	型号 Model	规格 Specifications
人字缝梭头 Zigzag	DSH-Z16	Φ7.24
	DSH-Z16(TS)	Φ7.24
	DSH-Z16B	Φ7.24
	DSH-7.24BJZ(586)	Φ7.24
	DSH-Z(20)	Φ7.24
	DSH-Z(20L)	Φ7.24
	DSH-BZ(20)	Φ7.24
	DSH-F12TR	Φ5.53
百福型梭头 PFAFF normal 杜克普型梭头 DURKOPP normal	DSH-SF12TR	Φ7.24
	DSH-PF335	Φ7.24
	DSH-PF335(5)	Φ7.24
	DSH-PF480	Φ7.24
	DSH-PF134	Φ7.24
	DSH-PF490	Φ7.92
	DSH-PF490(A)	Φ7.92
	DSH-490(5)TR	Φ7.92
	DSH-490A(5)TR	Φ7.92
	DSH-PF490(A)TR	Φ7.92
	DSH-PF490TR	Φ7.92
	DSH-PF545	Φ7.91
	DSH-PF545B	Φ7.91
	DSH-PF190	Φ7.92
	DSH-PF151	Φ7.92
	DSH-DU271	Φ7.24
	DSH-8-20	Φ6.35
	DSH-PF238	Φ7.24
	DSH-PF390	Φ7.92
	DSH-PF345	Φ7.92
百福 PFAFF	DSH-PF563TR	Φ7.24
	DSH-PF591	Φ7.92
	DSH-7.94BTR(PFQL)	Φ7.94
	DSH-490L(6)TR	Φ7.92
	DSH-FP442TR	Φ7.92
	DSH-NJ(761)	Φ7.93
	DSH-NJ(771)	Φ7.93
	DSH-LB(814)	Φ7.93
	DSH-DP2(107)	Φ7.93
	DSH-DP2(815)	Φ7.94
特殊梭头DP型 DP special type	DSH-DP2(457)	Φ7.94
	DSH-DP2(457)TS	Φ7.94
	DSH-DP2(457)T	Φ7.94
	DSH-DP2(LP457)	Φ7.94
	DSH-DP2(2280)	Φ7.94
	DSH-DP2(2290)	Φ7.94
	DSH-DP2(2290)J	Φ7.94
	DSH-PF(3114)	Φ7.94
	DSH-NJ(790)	Φ7.94
	DSH-NJ(790K)	Φ7.94
特殊梭头水平型 Horizontal special type	DSH-515(J)	Φ8.01
	DSH-515H(AJ)	Φ8.01
	DSH-451	Φ8.01
	DSH-116	Φ7.93
	DSH-810	Φ7.93
	DSH-810B	Φ7.93
	DSH-820	Φ7.93
	DSH-810-10	Φ7.93
	DSH-810-10A	Φ7.93

规格表 / SPECIFICATION

名称 Name	型号 Model	规格 Specifications
特殊梭头水平型 Horizontal special type	DSH2-557	Φ8.01
	DSH2-543A	Φ8.01
	DSH2-341	Φ7.93
	DSH2-8BL	Φ7.93
特殊梭头 长轴/小型 Special long axis/small type	DSH-111	Φ9.52
	DSH-516	Φ9.52
	DSH-831	Φ9.52
	DSH-831H	Φ9.52
	DSH-831HNH	Φ9.52
	DSH-835	Φ9.52
	DSH-842	Φ9.52
	DSH-842TR	Φ9.52
	DSH-842NH	Φ9.52
	DSH-842H	Φ9.52
特殊梭头 长轴/小型 Special long axis/small type	DSH-845	Φ9.52
	DSH-845TR	Φ9.52
	DSH-845H	Φ9.52
	DSH-845NH	Φ9.52
	DSH-112	Φ9.52
	DSH-265	Φ9.52
	DSH-275	Φ9.52
	DSH-1152	Φ9.52
	DSH-1152(2)TR	Φ9.52
	DSH-1152(2)	Φ9.52
特殊梭头 长轴/大型 Special long axis/big type	DSH-1162(L)	Φ9.52
	DSH-1162(R)	Φ9.52
	DSH-3168	Φ9.52
	DSH-3168TR	Φ9.52
	DSH-3128	Φ9.52
	DSH-3128TR	Φ9.52
	DSH2-570	Φ9.52
	DSH2-1182(L)	Φ9.52
	DSH2-1182(R)	Φ9.52
	DSH2-1182TR(L)	Φ9.52
特殊梭头 长轴/大型 Special long axis/big type	DSH2-1182TR(R)	Φ9.52
	DSH2-100-22	Φ9.52
	DSH2-260-22	Φ9.52
	DSH2-260-22(A)	Φ9.52
	DSH2-275-20	Φ9.52
	DSH2-563	Φ9.52
	DSH2-563(A)	Φ9.52
	DSH2-837	Φ9.52
	DSH2-838	Φ9.52
	DSH2-872	Φ9.52
DSH2-872TR	Φ9.52	
特殊梭头 长轴/大型 Special long axis/big type	DSH2-872NH	Φ9.52
	DSH2-875	Φ9.52
	DSH2-875TR	Φ9.52
	DSH2-875NH	Φ9.52
	DSH2-3188	Φ9.52
	DSH2-3188TR	Φ9.52
	DSH2-1510TR	Φ9.52
	DSH2-1510(A)TR	Φ9.52
	DSH2-8LCS	Φ9.52
	DSH2-8LCR	Φ9.52
DSH2-877	Φ9.52	

TOPDIS

BOBBINS

梭芯系列

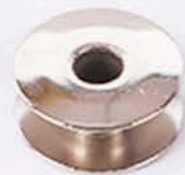

BOBBINS

TOPDIS

BOBBINS 梭芯系列

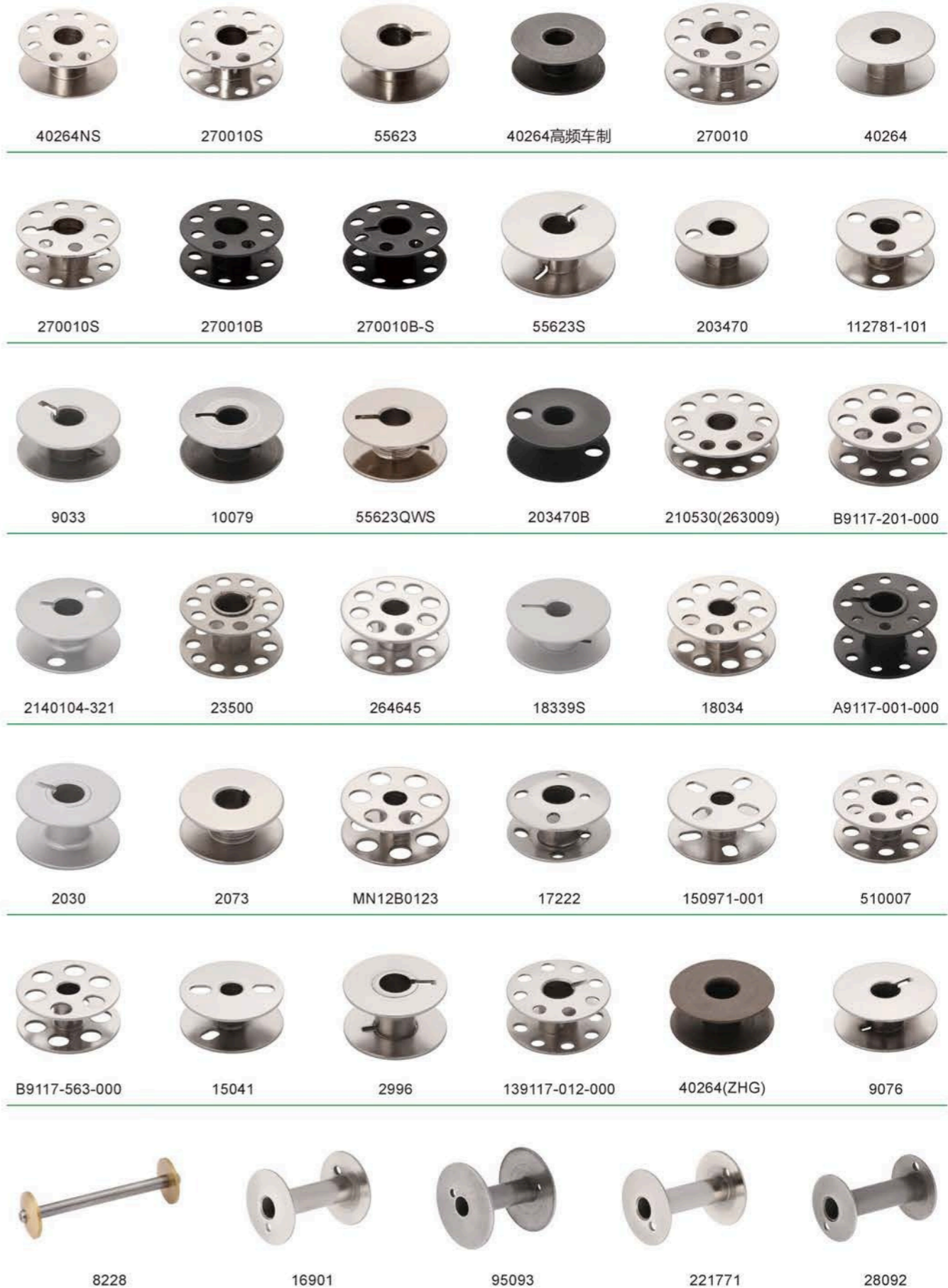

# TOPDIS

## BOBBINS 梭芯系列



# TOPDIS

## BOBBINS 梭芯系列



### FOR BROTHER 兄弟



112436-001 B531    S28352-001 B272    S20582-001 N11    S20583-001 N11    S20899-001 N11    S09101-001 B271    144074-001 B531    144074-300 B531



148342-001 B511    148815-001 B531    S20579-101 N11    S20896-101 N11    S20897-101 N11    S20898-101 N11    S09093-001 B271    S09094-001 B271



S28348-001    140888-001 EF2-B531    S28650-201    S28654-001    S16413-001 B787-4    S10605-001 B777    S16248-001 BAS-610    S07527-001 T8422/T8452/T8752



S07525-000 T8422A /T8452A/T8752A    S07526-001 T-842/T-845/T-875    S07526-201 T8422A /T8452A/T8752A    S07526-301 T8422B /T8452B/T8752B    154575-001 B716-400    154568-001 B716-400    S02645-001 B737-400 S-6200/SL211    S02637-001 B737-400 S-6200/SL211

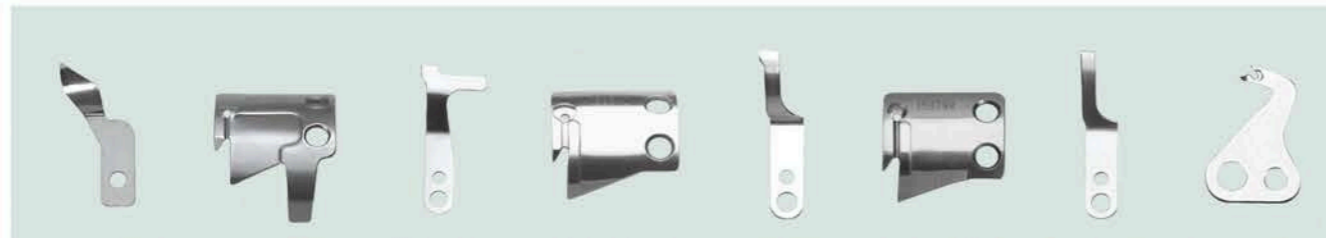

S02643-001 B737-400/S-6200 SL211/S-7200C    S02646-001 S-7200C    S02637-101 S-7200C    159541-001 B791-403    159540-001 B791-403    159799-001 B728    154568-101 B728    S03627-001 B917

### FOR BROTHER 兄弟



S03629-001 B917    S00706-201 LK3-B484    S00713-001 LK3-B484    S01584-001 LK3-B484    152901-001 LK3-B430    152906-101 LK3-B430    152905-001 LK3-B430    152981-001 LK3-B430



153219-001 LK3-B430    152897-201 LK3-B430    S10205-001 BAS-311A    S10210-001 BAS-311A    S49988-001 B430E    S10210-201 B430E    S02375-001 BAS-326    S02374-001 BAS-326

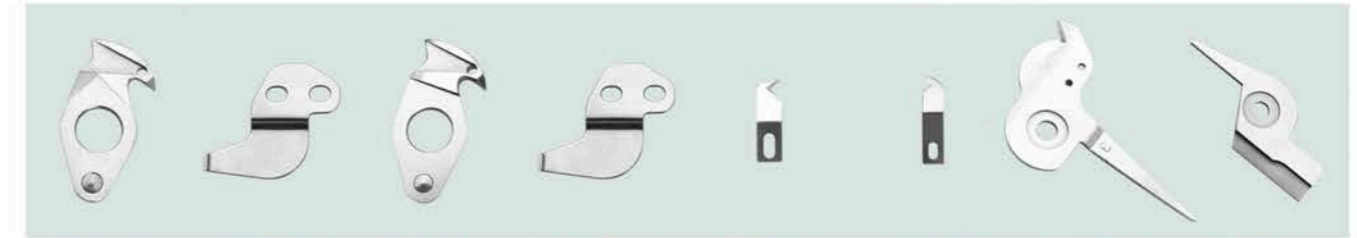

SA3330-001 SA6596-001 KE-430D    SA3335-001 KE-430D    SA3656-001 SA6429-001 KE-430D    SA3658-001 KE-430D    S37723-001 RH9820/B981    S35029-001 RH9820/B981    S37671-101 B980-L3    S37675-101 B980-L3



S37672-101 B980-L4    S37676-101 B980-L4    SA6989-001 RH9820    SA6988-001 RH9820    S34899-001 RH9820    S34895-001 RH9820    142419-001 LH4-B814



141509-101 LH4-B814    S19824-001 LH4-B815/B816    S50404-301 HE-800A    S50259-101 HE-800A    141541-001 LH4-814    141541-101 LH4-B814    141543-001 LH4-B814

### FOR BROTHER 兄弟

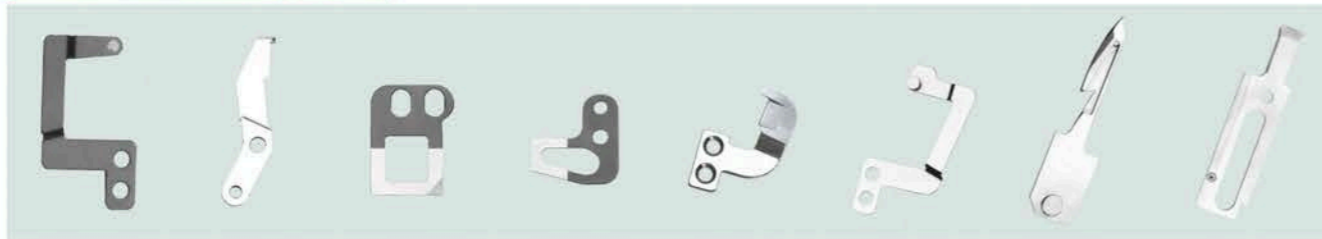

142416-001 LH4-B814    159274-001 LH4-B815    159276-001 LH4-B815    S56917-001 HM-818A    S56370-001 HM-818A    S56368-001 HM-818A    S55863-001 ZE-856A  
S58943-001 ZE-856A(H)    S55864-001 ZE-856A  
ZE-856A(H)



S21230-001 CH-1    S21233-001 CH-1    S21252-001 CV-1    S21253-001 CV-1    S55863-001 Z-8560A  
S58943-001 Z-8560A(H)    SA8459-001 Z-8560A  
Z-8560A(H)    SA1360-001 T-8420A/T-8421A  
T-8452A/T-8720A  
T-8722A/T-8752A  
S-7200A

### FOR DURKOPP 杜克普

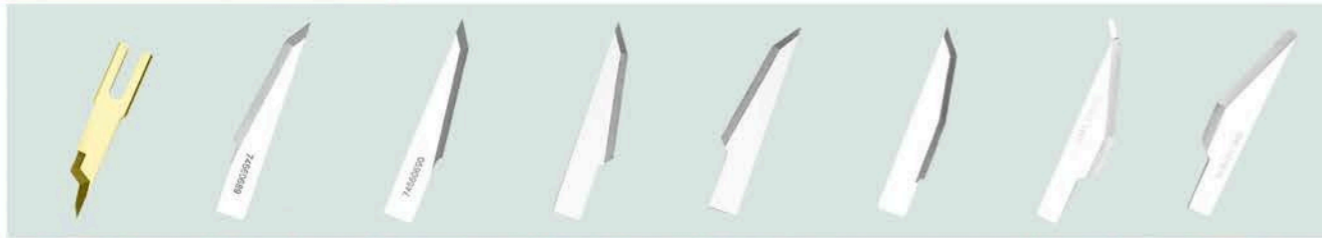

246-2553(TI) 745    746-60689 746    746-60690 746    746-60692 746    746-60691 746    746 746    745339120 745-34    745339130 745-34



745339100 745-34    745339110 745-34    227682 697    227683(TI) 697    2652197 697    2711497 271    0271001483 271    396 351690 550-16



51009080    5100912    625790 557    625780 557    568 350050 550-16    558 9011 559    570-974 570

### FOR JUKI 重机

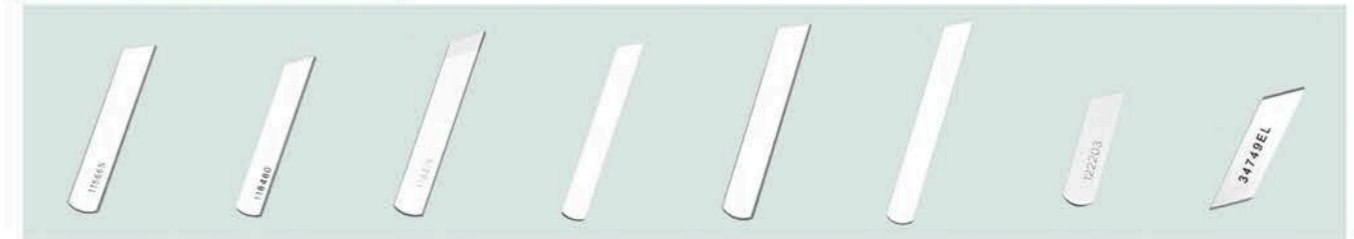

115-66502 MO-1516    118-46003 MO-2414    118-47605 MO-2500    118-8610 MO-2000    B4118-804-000 MO-1014    B4118-804-00C MO-816    122203 MOG-3904    34749EL MFC7605U-H21



408-9102-01-A BL3-408    B4122-352-00A MO-352    12447504 MO-3300    13150701 MO-6700    400-38091 MF-7700    400-42378 MF-7800    134-60803 MF-7800H20    408-9101-01-B BL3-408

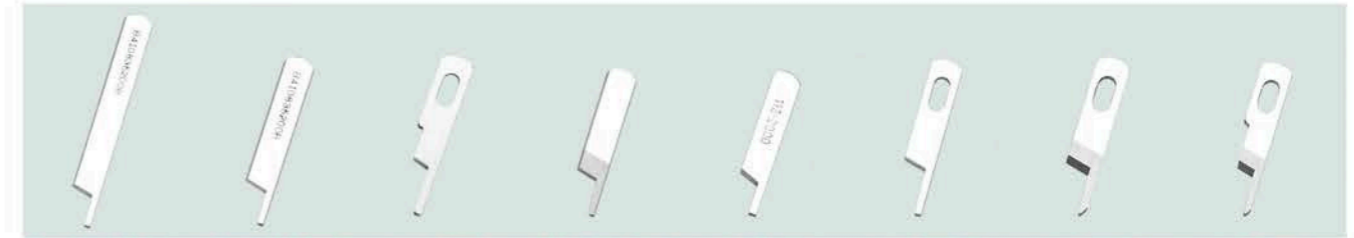

B4108-352-00B(L) MO-352    B4108-352-00B MO-352    118-47506 MO-2316    B4108-352-00D MO-352    118-2000 MO-2000    118-47407 MO-2314    118-45609 MO-2414    118-45708 MO-2416



124-45508 MO-3300    120-04909 MO-2516    13150602 MO-6700    13150503 MO-6700    115-65900 MO-1516    118-45807 MO-2414    118-45906 MO-2416    B4111-804-00A MO-814



B4111-804-00C MO-816    B4111-804-00E MO-1514    400-38754 MF-7700    400-39364 MF-7800    134 61801 MF7800H20    B1530-352-000 MO-352    B1528-804-000A MO-2414    13116702 MO-6700

FOR JUKI 重机



115-21903 MO-1516    124-19602 MO-3300    B1130-026-000 MS-261    B1131-026-000 MS-261    12922704 MS-1190/MS-1260    MAT-02203000 T022    MAT-02204000 T022    MAT-03505000 T041

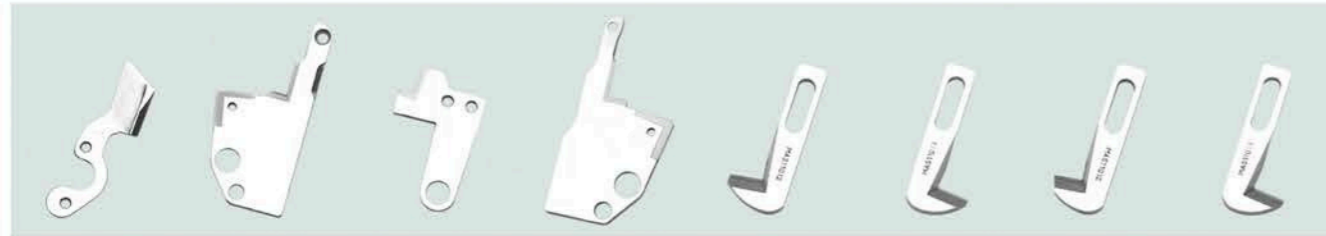

MAT-03506000 T041    MAT-0360500A T042    MAT-03606000 T042    MAT-04302000 T043    CTMAS-11012 MFB-8600    CTMAS-11013 MFB-8600    MAS-11012 MFB-2600    MAS-11013 MFB-2600

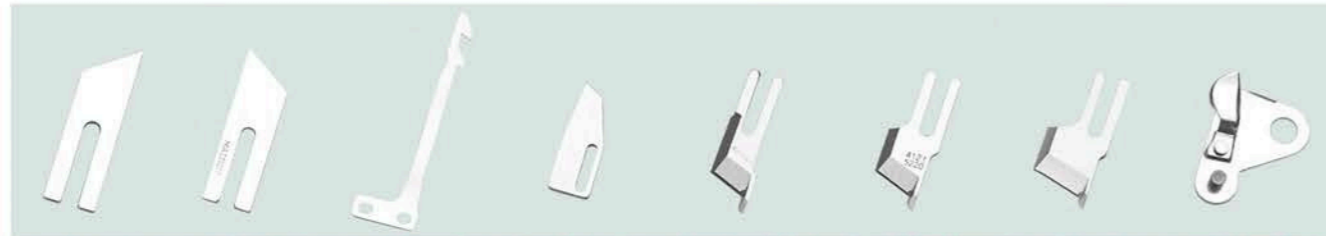

MAS-11016 MFB-2600    MAS-11017 MFB-2600    305-00300 MFC-7605U75    303-65407 MFC-7605U75    B4121-052-A00 DLM-522    B4121-522-000 DLM-522    B4145-530-B00 DMN-530    B2406-373-0A0 MB-373

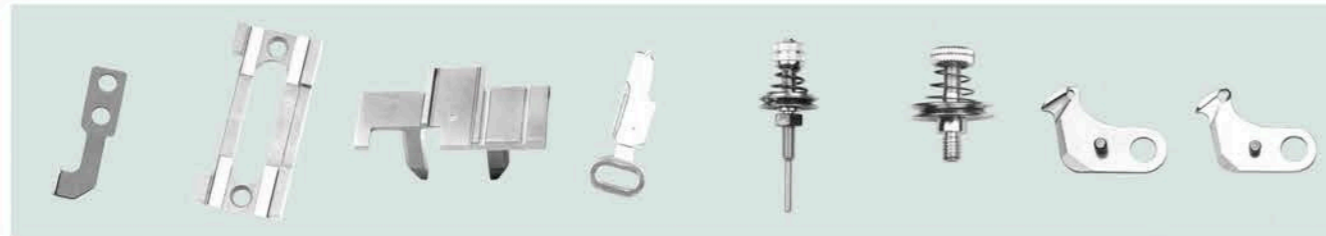

B2410-373-000 MB-373    B1235-373-000 MB-373    B1236-373-000 MB-373    B1237-373-000 MB-373    B2019-372-0A0 MB-373    B2015-372-0A0 MB-373    110-40052 DDL-5550-6    110-93259 DDL-5550H-6



D2406-555-DOH DDL-5550-6    D2405-555-B00-B DDL-555-5    110-40201 DDL-5550-6    D2401-530-D00 DMN-530-5    D2404-530-D00 DMN-530-5    114-09257 DDL-5550NH-7    114-09604 DDL-5550NH-7    110-95403 DDL-5550NH-7

FOR JUKI 重机



D2402-555-BAO DDL-555-5    D2402-555-BAB DDL-555-5    D2402-415-BAO DDL-555-5    D2406-555-B00 DDL-555-5    113-13053 DLN-5410-6    10502300 LK-1900    B2421-280-0A0 LK-1850    B2424-280-000 LK-1850

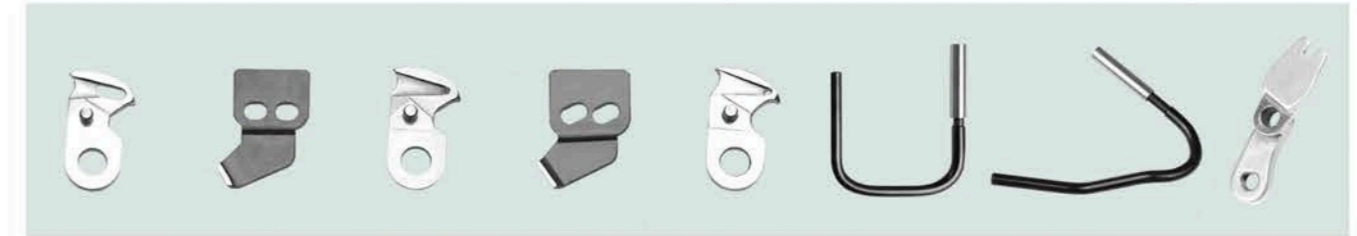

B2421-210-AA0 AMS-210D    B2424-210-000 AMS-210D    B2421-210-000 AMS-215C    B2424-210-A00 AMS-215C    B2421-205-0A0 AMS-210C    110-42652 DDL-8700    D2408-555-CAO DDL-8700    110-95601 DDL-8700



110-40508 DDL-8700    D3161-555-BAO DDL-8700    D2423-141-E00 DU-141-5    D2424-141-E00 DU-141-5    113-51400 DMN-5420-6    113-51509 DMN-5420-6    225-57557 LZ-2290A    225-57706 LZ-2290A



G5252-116-A00 APW-116    G5253-116-A00 APW-116    5649-116-A0A B116A    164-01002 APW-192    164-03008 APW-192    164-18600 APW-195    164-16109 APW-235    164-18709 APW-235

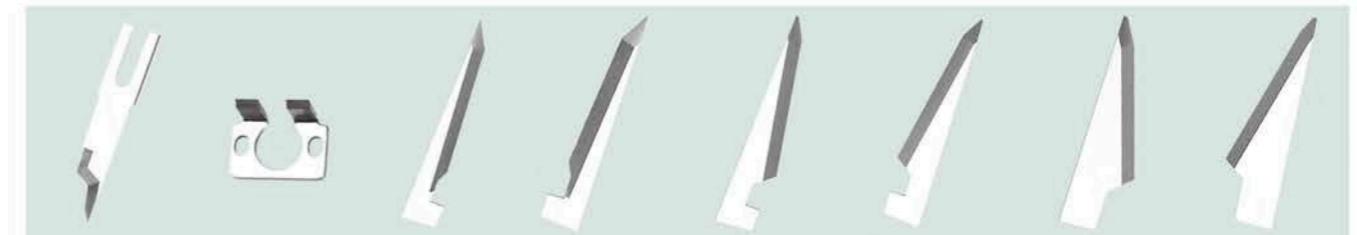

400-26155 APW-895    16409906 APW-895    166-07301 APW-192    166-07400 APW-192    166-07509(B-1) APW-192    166-07608(B-2) APW-192    166-07707(C-1) APW-192    166-07806(C-2) APW-192

### FOR JUKI 重机



400-33809 APW-895/896    400-33814 APW-895/896    400-23020 APW-895/896    40034923 MEB-3200    40015996 MEB-3200    32020505 MEB-3200    40029004 UT25/UT33    13458500 UT25A/UT33A



23136005 MP-200    B2408-761-000 LBH-761    B2406-761-0A0 LBH-761    B2406-771-0A0 LBH-780    B2408-771-000-A LBH-780    D9335-762-T00 LBH-762T    137-31161 LBH-790



137-35469 LBH-790    B2001-761-0A0 LBH-761    B2001-762-0A0 LBH-762    B2001-763-0A0 LBH-763    B2001-771-0A0 LBH-780    400-04255 LBH-1790    400-04311 LBH-1790



107-26305 LU-2216N-7    107-26404 LU-2216N-7    213-89200 LU-1560N-7    213-89309 LU-1560N-7    32018509 MEB-3200    400-12403 LH-3528-7    400-12404 LH-3528-7



102-32403 LH-1162    102-11209 LH-1162/1152    102-11118 102-11100 LH-1162/1152    226-55302 LH-3128-7    228-20302 LH-3178-7    102-11605 LH-3128-7 LH-3178-7    40025949 LH-4128-7 LH-4168-7

### FOR KANSAI SPECIAL 森本

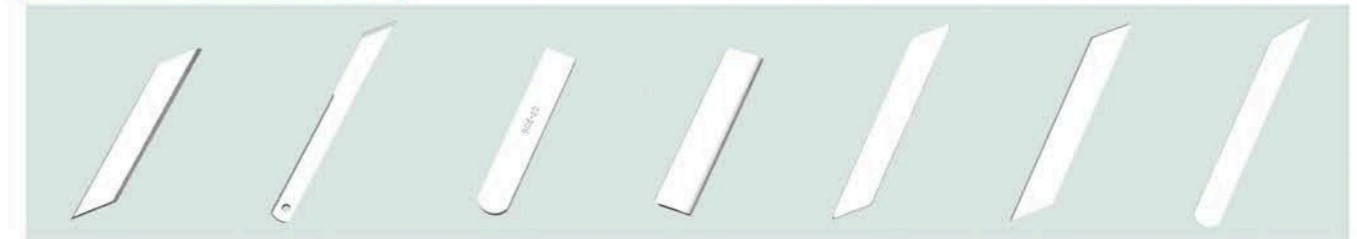

07-125    07-169 W802    07-206 1702    07-432 BLX    07-507 WX8700    07-522 WX-EMK    07-529 DZX-3U

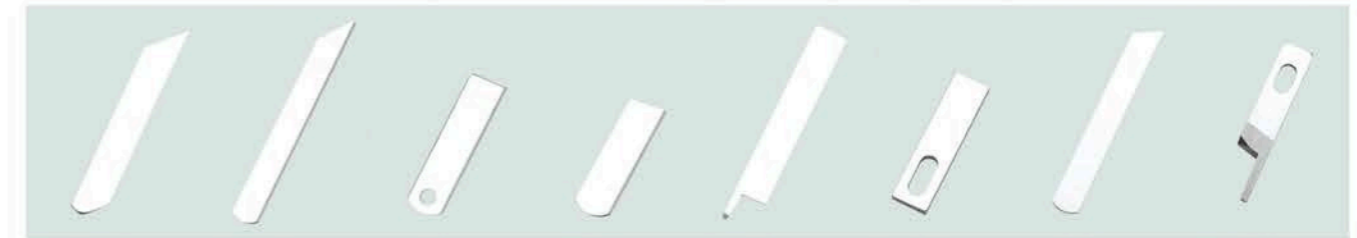

07-558 RX9800    07-596 RX    07-621 S-6604D    07-634 FSX/MH    07-631 FSX/MH    07-707 B2000C    56-860    56-857



07-505 WX8700    07-170 W8103    07-124 1702    07-406 1702    07-168 W802    07-570 RX    07-544 RX9800    07-545



07-597    07-702 B2000C    07-703 B2000C    05-878    05-658 RX9800    05-812 RX9800    52-275 BK-20    52-288 BK-20



56-304    08-005 WX    05-548 FX4404    05-429 FX4404    05-447 FX4404    05-549 FX4404

### FOR KINGTEX 宝狮

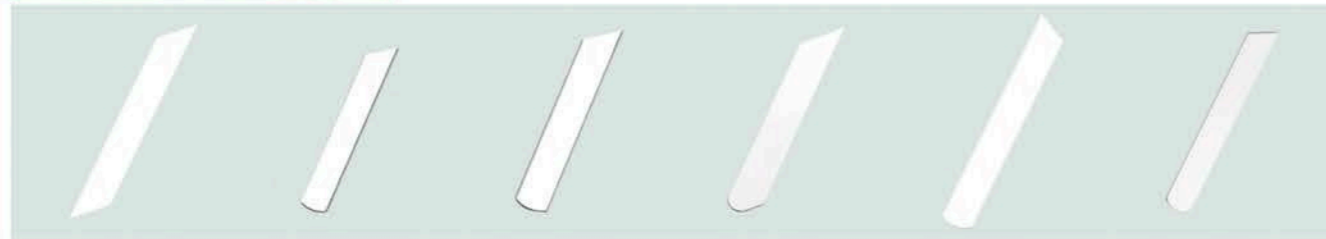

2210090242 FT39    G6050114P700 SHG 6005    6031218P700 SH 6004    2206110119 CTL6511    2120000715 UH 8000    212010010 UH8000



2210090242 FT39    5240PF0109 N67    6031314C500 SH 6004    G6050113C500 SHG 6005    2120000708 UH 8000    4AG0050103 UH8000    4AG0030104 UH8000



22100902372    2200850222 CT85    2206110120 CTL6511    2273110120 CT9311    G6050122D700 SHG6005    G20-22 SHG6005    UTB0118 CT6500    UTB0115 CT6500

### FOR MITSUBISHI 三菱



MF00A0834 LS2-180    MF00A0838 LS2-180    A141D676H01 LS2-180    MF02A0834 PLKA-2010    MF02A0838 PLKA-2010    MS07A0782 PLKA-2010    MS07A0180 PLKA-2010    MG52A0834 DY-359



MG52A0838 DY-359    MP41A0838 LT2-250    MP41B0838 LT2-250    MN50A0838 LT2-250    MN50B0838 LT2-250    MF90A0838 CS2-190 PLK-1210    MS03B0838 PLKA/B-1006    MS03A0838 PLKA/B-1006

### FOR MERROW 美罗



6-91    6-91E    6-91K    6-90    6-90-C    A-90-3 70-DB3    A-90-7 D4

### FOR PFAFF 百福



91-140726-01    91-141911-01    91-264338-15 1481/1483/1487 2481/2483/5463/5483 5489/3566/3568 3588/3819/3822/3827    91-264240-05 1050/1180 951/953/563    91-014046-05 1050/1180    91-165505-05 333/335/337 461/463/469/481/483/487 489/1051/1053/1181/1183

### FOR PEGASUS 飞马



202893 E/L52/R    202295 E/L52/R    2022950 M852-13    201127 E/L52/R(薄)    204161 L32/W562    2041610 M832-70    204161A W664-35



137562 DC/DCP/DCM    200959 DCM-204    277009 EX5214    204351 L32-38    205609 R57L    213108 E51-210    138559 DCP-101    200971 DCM-204

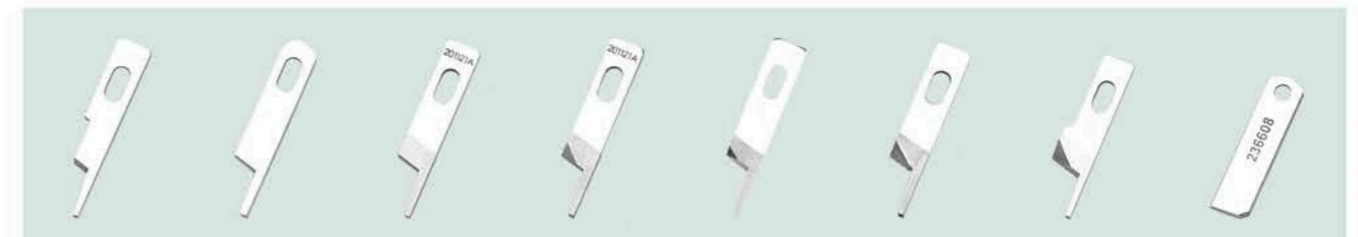

202527A L32-38    202570 E/L/R    201121A E52/L52/R53 EX3200/EX5200    201121ANS E52-131    201121A0 M800    205890 E    277000 EX5214    236608 FS601/FS603

### FOR PEGASUS 飞马

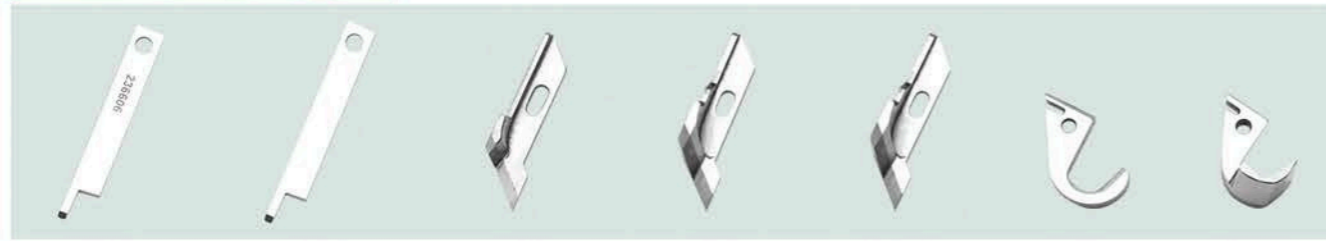

236606 FS601/FS603    236618 FS601/FS603    210755 EX3200/EX5200    211662 EX5214H    211662A EX5214H    306394 W562/W61/WS62    257573 W664-05

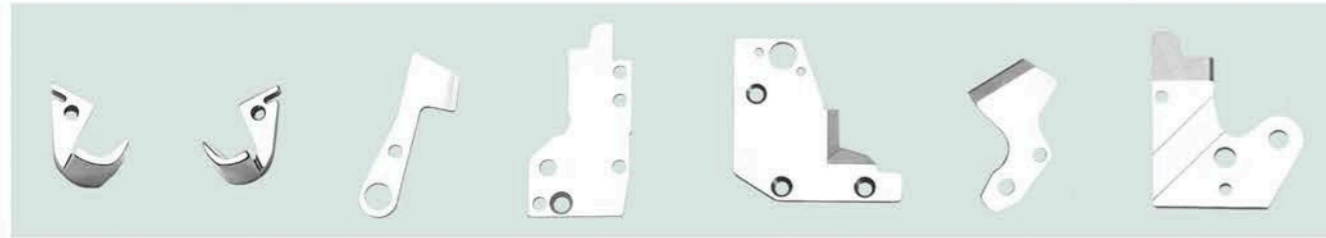

257573A W664-33    257574 W664-35    301008 E52(KS)    301006 E52(KS)    301035 E32(KH)    301036 E32(KH)    179458-05 EX52/KS



179459-05 EX52/KS    303363 L52(KS)    303360 L52(KS)    308030 EX32    308026-91 EX32    340406 EX1023    340468 EX1023



350018-91 W762/UT    350024 W762/UT    350220 W664/UT    350218 W664/UT    201308 L32-38    202451 E32-420    350083 TK310



350081 TK310    36278D 36200    301138 E32    303131 E32(TK)

### FOR RIMOLDI 利满地



270-113 27/327/527/627    270-113/1 202146-0-10 27/327/527/627    CT270-113/1 27/327/527/627    207015-2-00 27/327/527/627    203144-0-10 27/327/527/627    302808-0-10 63    277-113 203012-0-10 27/327/527/627    CT277-113 27/327/527/627



207016-2-00 27/327/527/627    315507-0-00 63/64/65 155/261/262/263 264/73/91/93/94    279-113/1 27/327/527/627    290-113SP 204693-0-11 27/327/527/627    207651-0-00 27/327/527    207025-2-00 27/327/527/627    306283-2-00 63/64/65 155/261/262/263 264/73/91/93/94    209344-2-00 27/327/527/627



350452-0-00 183-00-4    350453-0-00 183-00-4    CT290-113 207020-2-00 207020-2-01 27/327/527/627    290-113 204693-0-10 27/327/527/627    270-112 202142-0-10 27/327/527/627    290-112 203783-0-10 27/327/527/627    202932-0-10 27/327/527/627    279-112 203066-0-10 27/327/527/627



209348-0-10 27/327/527/627    209356-0-00 27/327/527/627    209352-0-10 27/327/527/627    270-112/1 202143-0-10 27/327/527/627    277-112 203010-0-10 27/327/527/627    203759-0-10 27/327/527/627    209350-0-10 27/327/527/627    209354-0-10 27/327/527/627



209341-0-10 27/327/527/627    CT270-112 207000-2-00 27/327/527/627    209340-2-01 27/327/527/627    CT290-112 207003-2-00 27/327/527/627    CT276B-112 207001-2-00 27/327/527/627    207006-2-00 27/327/527/627    209347-2-01 27/327/527/627    209355-2-01 27/327/527/627

## FOR RIMOLDI 利满地



209351-2-01 27/327/527/627  
 CT277-112 207002-2-00 27/327/527/627  
 207004-2-00 27/327/527/627  
 209357-2-01 27/327/527/627  
 209342-2-01 27/327/527/627  
 209341-0-00 27/327/527/627  
 209348-0-00 27/327/527/627



209352-0-00 27/327/527/627  
 302807-0-10 63  
 302865-0-11  
 202194-0-11 27/327/527/627  
 929197-0-02  
 928531-2-00  
 928530-2-00

## FOR SIRUBA 银箭

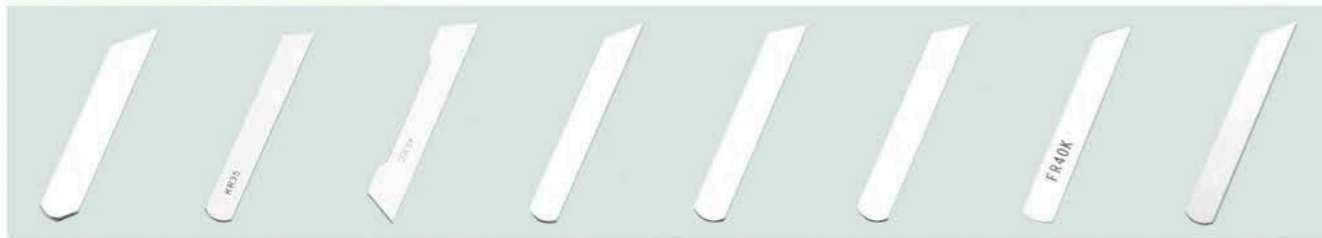

CRL09J C007J  
 KR35 747/700K  
 KR35C 757  
 FBQ30 F007E/FBQ  
 FR40 HF008/FBQ  
 FR40D F007E/FBQ  
 FR40K F007K/FR  
 FR40J F007J/FR



KR55 700FS  
 KR23 747  
 KR23A 747  
 KR23C 757  
 AN02 747K/AN  
 AN12 747K/AN  
 FR34B HF008/FBQ  
 FR34 HF008/FBQ



FR134 F007J  
 FR34H F007  
 CR26J C007J  
 CR26H C007E/CRL  
 CRL03 C007E/CRL  
 CRL03H C007H/CRL  
 CRL03J C007E/CRL  
 CR26

## FOR SIRUBA 银箭



CRL103 C007J  
 CRL04J C007E/CRL  
 CRL04H C007H  
 LR21 L818F-RM1  
 UT317  
 UT318  
 UT507 C007J  
 UT506 C007H

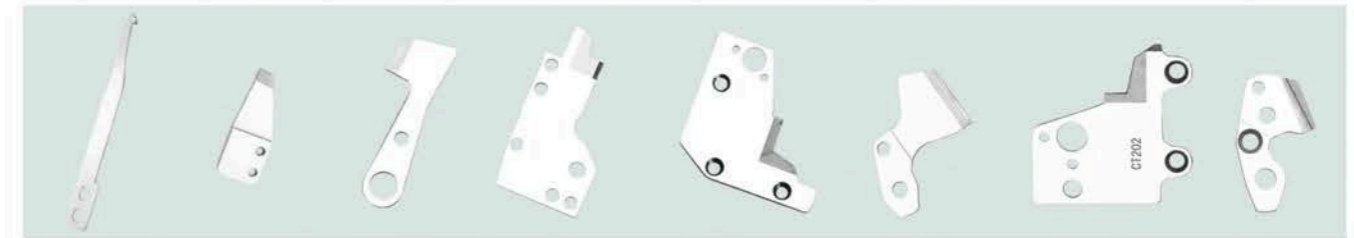

UT758 F.C.S007  
 UT759 F.C.S007  
 VT05 747/VT  
 VT04 747/VT  
 CT18-1 747/CT  
 CT19 747/CT  
 CT202 700K/CT  
 CT203 700K/CT



DT05 700D/FT  
 DT06 700D/FT  
 FV08 F007J/FV  
 VT205 700K/VT  
 VT206 700K/VT  
 LU02 L818F-M1  
 LU05 L818F-M1  
 LU04 L818F-M1



LU602 L819  
 LU605 L819  
 LU101  
 LU103  
 LU501  
 LU503  
 BG127  
 BG130D



UM105 T828  
 UM104 T828  
 RU10 351/991T  
 RU14 351/991T  
 BK10F  
 KS24 700K  
 A702 AA  
 A703 AA  
 EC05

## FOR SUNSTAR 日星



10-006A-235B KM-250    10-001A-2700 KM-250    10-106A-2700 KM-250    10-101A-2700 KM-250    10-006A-120H SPS/A-B1201    10-001A-120H SPS/A-B1201



10-002A-7507 KM-757    10-007A-7507 KM-757    10S047S-306H SPS/A-1306 SPS/B-1306    10S045S-306H SPS/A-1306-HS SPS/B-1306-HS    10-008A-64L7    10-001A-64L7



GP-010014-00 SC7310    10-111A-8677 KM967-7    GP-025627-01 KM967-7    GP-001544-00 SC7300

## FOR SINGER 胜家

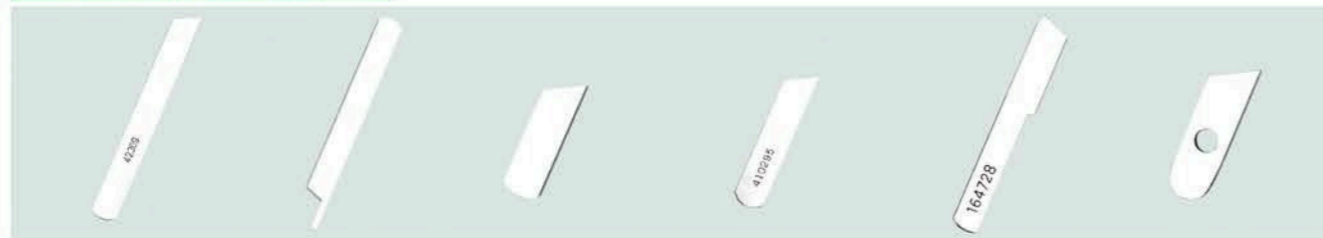

42309 81    42305 81    412749 14U    410295 14U    164728 246.460    550449 14U-544



412585 14U    164550    548845 299U.T.T    548851 299U123    253775 299U123    548865 299U123

## FOR SINGER 胜家



253647 299U123    544533 299U    411088 457U    502670 457G 457U    540741 591    540760 591

## FOR TOYOTA 丰田



2111407-553-A AD-158    2111407-553-B AD-158    2111417-556-B AD-158    0252072-145-B AD-157    0252052-141-C AD-157

## FOR UNION SPECIAL 于仁

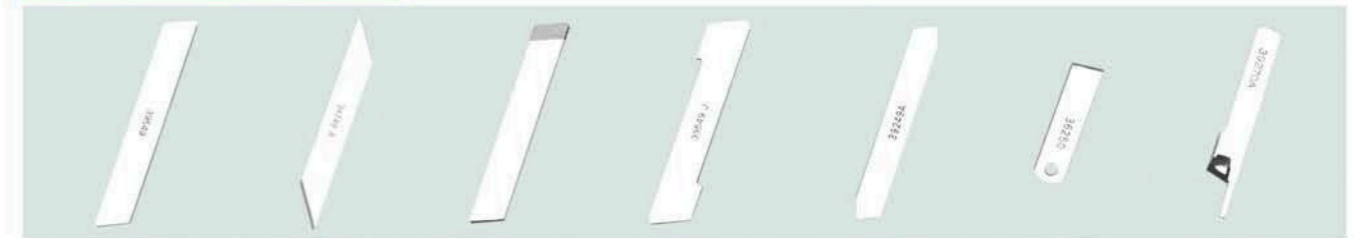

39549 39500    34749A    39549N 39500    39549J 39500    39249A 39200    36250 36200    39270A 39200



39270D 39200    39270E 39200    39270K 39200    36270 36200    36270B 36200    39570 39500    CT39570 39500



39570J 39500    39570K 39500    39570L 39500    35796B 35700/35800    35796C 35700/35800

### FOR YAMATO 大和



2100167 AZ-8000    2121111 AZF-8600    22195 Z-6000    30421 DCZ-2000    35285 DCZ-341    37538 DC-100    3101026 VC-2685    3101633 VC-2629



3110038 VC-3611    3201062 VF-2509    95277 DW-1359    3501026 VG2735    6200097    37514 DC-100    68121 68121(HSS) FD-62    68185 FD-62-01

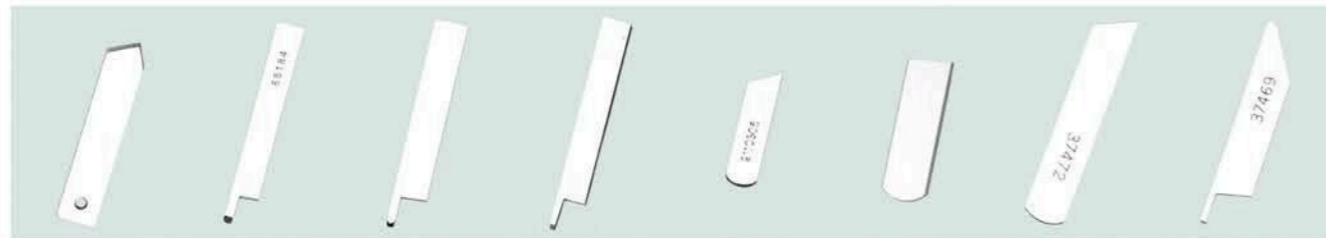

68184 68184(HSS) FD-62    3021109(宽/Wide) FD-62    3021111(宽/Wide) FD-62    3021111 FD-62    2110305 AZ8400    3021109    37472 37472(HSS) DCY-104    37469 37469(HSS) DCY-104



CT37469 DCY-104    36415 DCZ-200    6200022 AZ8120G    20496 Z6000    2150256 AZ8120G    32914 DCZ-200    32914-7 DC2-200    95276 DW-1359



3110037 VC-3611    3101465 VC-2629    3101028 VC-2685    3501032 VG2735    3501597 VA-3721    3501535 VA-3721    3501534 VA-3721    20491 Z6000

### FOR YAMATO 大和



2121107 AZF-8600    35286 DCZ-341    20271 Z-1000    32706 DCZ-200    3100513 VC-2713/UT    CT3100512 VC-2713/UT    3100512 VC-2713/UT    94411 95399



94417 DW-1367    2101220 AZ8020/KH    2101221 AZ8020/KH    2111056 AZ-8020    2111055 AZ-8020    2101156 AZ-8500    2101155 AZ-8500



3021060 FD62-01    3021061 FD62-01    6200020 LG1500    5000261 LG2200    5000262 LG2200    3112005    3112006

### OTHER 其他系列



EH1644-OA    KE043    613140    81000670    103-019 ACF-103N-3    KE029    KE030



KE031    2122207-113    81000669    ABLE/HB-90-L    ABLE/HB-90-S    KE019    77005

### OTHER 其他系列

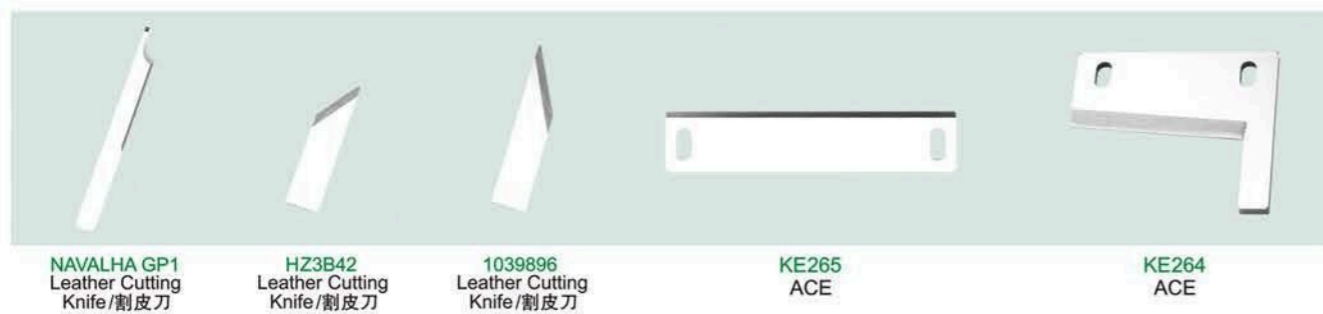
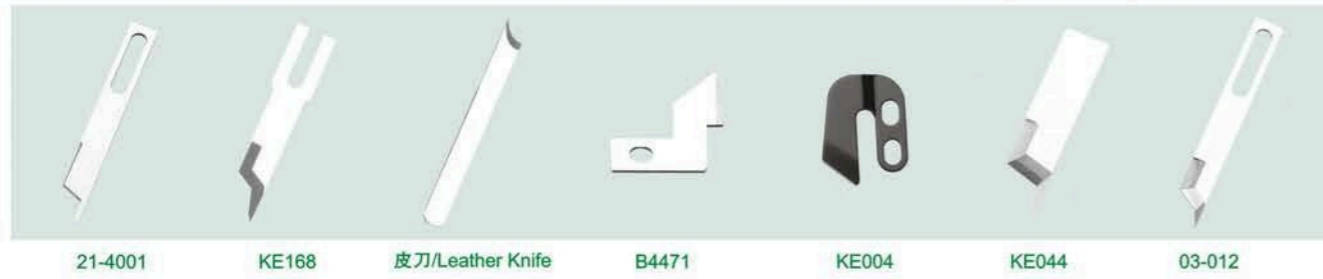
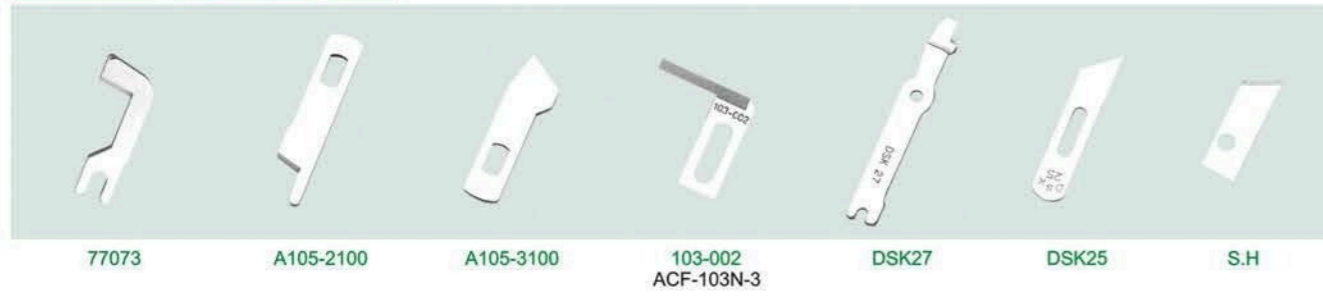

### FOR BROTHER 兄弟

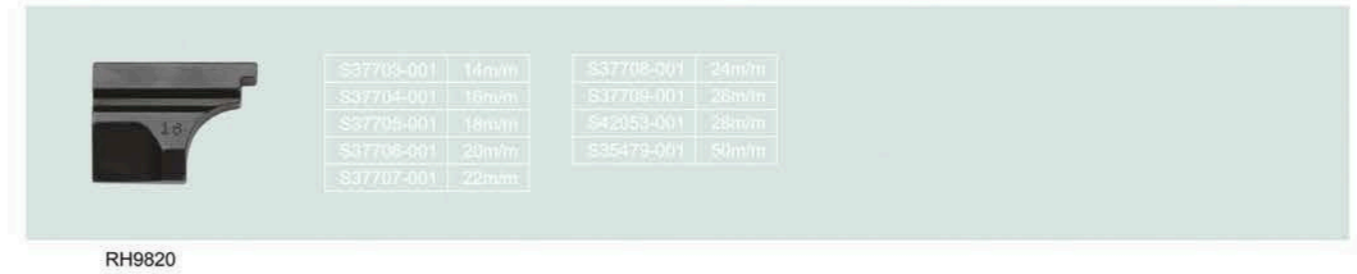

### FOR DURKOPP 杜克普

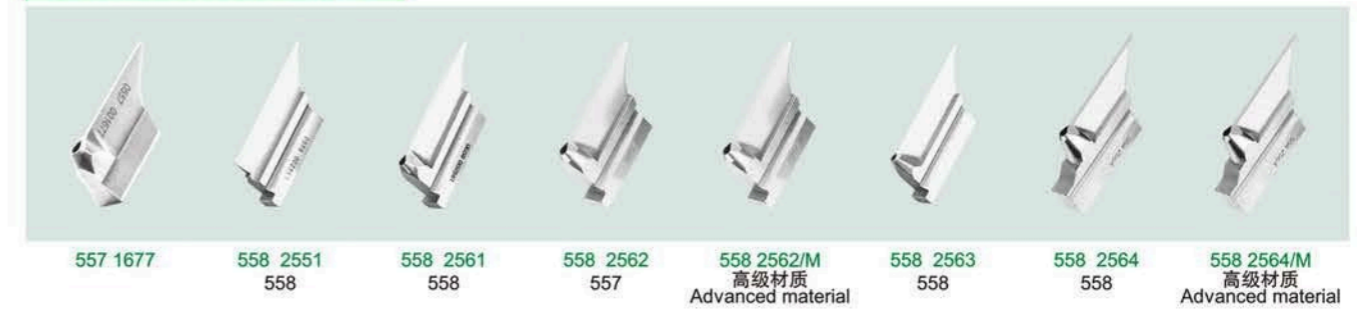

### FOR DURKOPP 杜克普



558 2408	18mm
558 2407	20mm
558 2408	22mm
558 2409	24mm
558 2410	26mm

558 2411	28mm
558 2412	30mm
558 2413	34mm
558 2414	38mm



0580 330040	16mm
0580 330050	18mm
0580 330060	20mm
0580 330070	22mm
0580 330080	24mm
0580 330090	26mm

0580 330100	28mm
0580 330110	30mm
0580 330120	32mm
0580 330130	34mm
0580 330140	36mm
0580 330150	38mm

558

559



578 3283	14mm
578 3284	16mm
578 3285	18mm
578 3286	20mm
578 3287	22mm
578 3288	24mm

578 3289	26mm
578 3290	28mm
578 3291	30mm
578 3292	32mm
578 3293	34mm
578 3294	36mm

578

### FOR JUKI 重机

14041206  
MEB-320014041206/M  
高级材质  
Advanced material

MEB-3200

32063505	10mm
32063400	12mm
32063307	14mm
32063208	16mm
32063103	18mm
32063000	20mm
32062903	22mm
32062804	24mm

32062705	26mm
32062606	28mm
32062507	30mm
32062405	32mm
32062309	34mm
32062200	36mm
32062101	38mm

### FOR LSM

113-043-000  
LSM-150

111-150-000	13mm
111-151-000	16mm
111-152-000	19mm
111-153-000	22mm
111-154-000	25mm
111-155-000	28mm
111-156-000	32mm

### FOR REECE 利是

10-3072-0-024  
1010-3072-0-024/M  
高级材质  
Advanced material10-3072-0-014  
10110-3072-0-014/M  
高级材质  
Advanced material17-0064-5-864 3/5CA  
10017-0064-5-864 3/5CB  
100

17-0064-5-863

### FOR REECE 利是

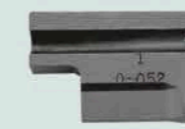

10-1069-0-051	22mm
10-1069-0-052	25mm
10-1069-0-053	28mm
10-1069-0-054	32mm
10-1069-0-055	36mm
10-1069-0-056	38mm
10-1069-0-050	51mm

101



17-0064-5-851	13mm
17-0064-5-849	16mm
17-0064-5-852	22mm
17-0064-5-854	26mm
17-0064-5-855	28mm
17-0064-5-856	32mm
17-0064-5-858	36mm

100



REECE10013MM
REECE10018MM
REECE10020MM
REECE10024MM
REECE10029MM
REECE10030MM
REECE10035MM

100



10-1069-0-001	13mm
10-1069-0-002	16mm
10-1069-0-003	19mm
10-1069-0-004	21mm
10-1069-0-005	23mm
10-1069-0-006	25mm
10-1069-0-007	32mm

104

### FOR SINGER 胜家

548936  
299U544599  
299U548886  
299U548992  
299U233SW548935  
299U233SW255344  
299U233SW548066  
299U544600  
299U233

544567	3/4
544585	7/8
544598	1

299UX233MW



544596	7/8
--------	-----

299UX233MW



548837	3/4
548838	7/8

299UX233MW



548762	1/2"	548767	1 1/8"
548763	5/8"	548768	1 1/4"
548764	3/4"	548769	1 3/8"
548765	7/8"	548770	1 1/2"
548766	1"	548771	1 5/8"

299U



548752	1/2"	548757	1 1/8"
548753	5/8"	548758	1 1/4"
548754	3/4"	548759	1 3/8"
548755	7/8"	548760	1 1/2"
548756	1"	548761	1 5/8"

299U

## ABRASIVE BELT 砂带

UN-SD1001  
UN-SD1002



**特点:**

1. 砂粒 : 100~180目
2. 适用于电脑自动裁剪机、合金钢刀片、碳钢刀片和锋钢刀片等。

**FEATURES:**

1. Sand: 100~180 mesh
2. It is suitable in computer automatic cutting carbon steel, alloy steel blade knife blade, and feng.

## BAND KNIFE 钢带



Ø 3860/3500/4560/3960

## ROUND KNIFE 圆刀



R4 1/4"

## ELECTRIC CUTTING BLADES 电剪刀片/锁眼刀片



**特点:**

1. 材质选用来自德国、日本进口优质的精钢；硬度高，锋利。
2. 产品种类有直刀、波刀、圆刀、锁眼刀、削皮刀等。

**FEATURES:**

1. Material selection from Germany, Japan imported high quality stainless steel, High hardness, sharp.
2. Products include straight knife, wave knives, circular knives, keyhole knife, peeling knife, etc.

**规格表 / SPECIFICATION**

名称 Name	材质 Material	规格 Specification	名称 Name	材质 Material	规格 Specification	名称 Name	材质 Material	规格 Specification
直刀 Straight	SKS7	12"	波刀 Wave knife	SKS7	10"	锁眼刀 keyhole knife	SK2	1/4" -1"
直刀 Straight	SKS7	9" 10"	波刀 Wave knife	SKS7	8"	锁眼刀 keyhole knife	SK2	1" -1 3/8"
直刀 Straight	SKS7	7" 8"	波刀 Wave knife	SK2	10"	锁眼刀 keyhole knife	SKS7	1/4" -1"
直刀 Straight	SKS7	5" 6"	波刀 Wave knife	SK2	8"	锁眼刀 keyhole knife	SKS7	1" -1 3/8"
直刀 Straight	SK2	12"						
直刀 Straight	SK2	9" 10"						
直刀 Straight	SK2	7" 8"						
直刀 Straight	SK2	6" 5"						

# UNIQUE

## LED LAMP 衣车灯系列



Healthy & Eco-Friendly  
节能照明专家

# TOPDIS

LED LAMP 衣车灯系列

### UNLED-1 红外线定位灯系列 Laser Lamps



十字定位灯 CROSS LASER

直线定位灯 LINE LASER

点定位灯 POINT LASER

UN9700(Z-91-118240-91)  
UN9800(Z-91-117458-91)

UNLED-6 NEW

UNLED-6 双头灯 Double Heads

UNLED-5

UNLED-3 NEW



点动倒送料开关组件  
Jog feeding switch components

3-Levels Brightness Adjustable

3-Levels Brightness Adjustable

可调光 Brightness Adjustable

3-Levels Brightness Adjustable

UNLED-10

UNLED-20

UNLED-12

UNLED-18

UNLED-28



UNLED-16W 90CM 100-240V 16W 50/60Hz

UNLED-18W 120CM 100-240V 18W 50/60Hz

SAVE 60% ENERGY  
节能

60%  
以上

F-2-A



F型二线架A级 F-type 2 thread

F-2-B



F型二线架B级 F-type 2 thread

F-3-A



F型三线架A级 F-type 3 thread

F-3-B



F型三线架B级 F-type 3 thread

F-4-A



F型四线架A级 F-type 4 thread

F-4-B



F型四线架B级 F-type 4 thread

22876



八字型-2 8 type-2

22877



八字型-3 8 type-3

22878



八字型-4 8 type-4

T-4



F-5-A



F型五线架A级 F-type 5 thread

F-5-B



F型五线架B级 F-type 5 thread

F-6-A



F型六线架A级 F-type 6 thread



二十四线架(银箭型)(2000型)  
24 thread rack (SIRUBA) (2000 type)

F-8-A



F8型八线架A级 F8-type 8 thread



二十四线架(森本型)(1000型)  
24 thread rack (KANSAI SPECIAL) (1000 type)



小轮绕线器 (重机型) (镀锌) (259482)  
Small wheel bobbin winder for JUKI (coated Zn) (259482)



小轮绕线器 (兄弟型) (镀镍) (259482)  
Small wheel bobbin winder for BOTHER (coated Ni)



小轮绕线器 (喷塑) (259482)  
Small wheel bobbin winder (plastic jetting)



中轮绕线器 (兄弟型)  
Middle wheel bobbin winder for BOTHER



大轮绕线器 (喷塑、灰白、黑色) (259431)  
Big wheel bobbin winder for plastic jetting (grey, black)



大轮绕线器 (259431)  
Big wheel bobbin winder (259431)



810/820绕线器 (259431)  
810/820 bobbin winder



6-28厚料绕线器 (259431)  
6-28 heavy material bobbin winder



H001  
罗拉车 Postbed machine



H002  
高速平车 Lockstitch



H003  
电脑平车 (新款) Computer lockstitch (New)



H004  
电脑平车 (老款) Computer lockstitch (Old)

TEXTILE CLEANING GUN 喷枪系列



CM-11

TAGGING GUN 吊牌枪系列



UN-K001



UN-D501



UN-D506

TAPE RACK 捆条盘系列



UN-K110A

UN-K110B

UN-K110C

UN-K110D

WRENCHES 扳手系列



T型六角扳手  
T-TYPE HEX WRENCHES

- K805A-2.0
- K805A-2.5
- K805A-3.0
- K805A-4.0
- K805A-5.0



七件套公制六角扳手 (平头)  
METRIC HEX WRENCH  
(FLAT HEAD, 7 PCS/SET)

K-21



九件套公制六角扳手 (平头)  
METRIC HEX WRENCH  
(BALL HEAD, 9 PCS/SET)

K-811

SCREWDRIVER 螺丝刀系列

六角上针匙  
HEX KEY WRENCH

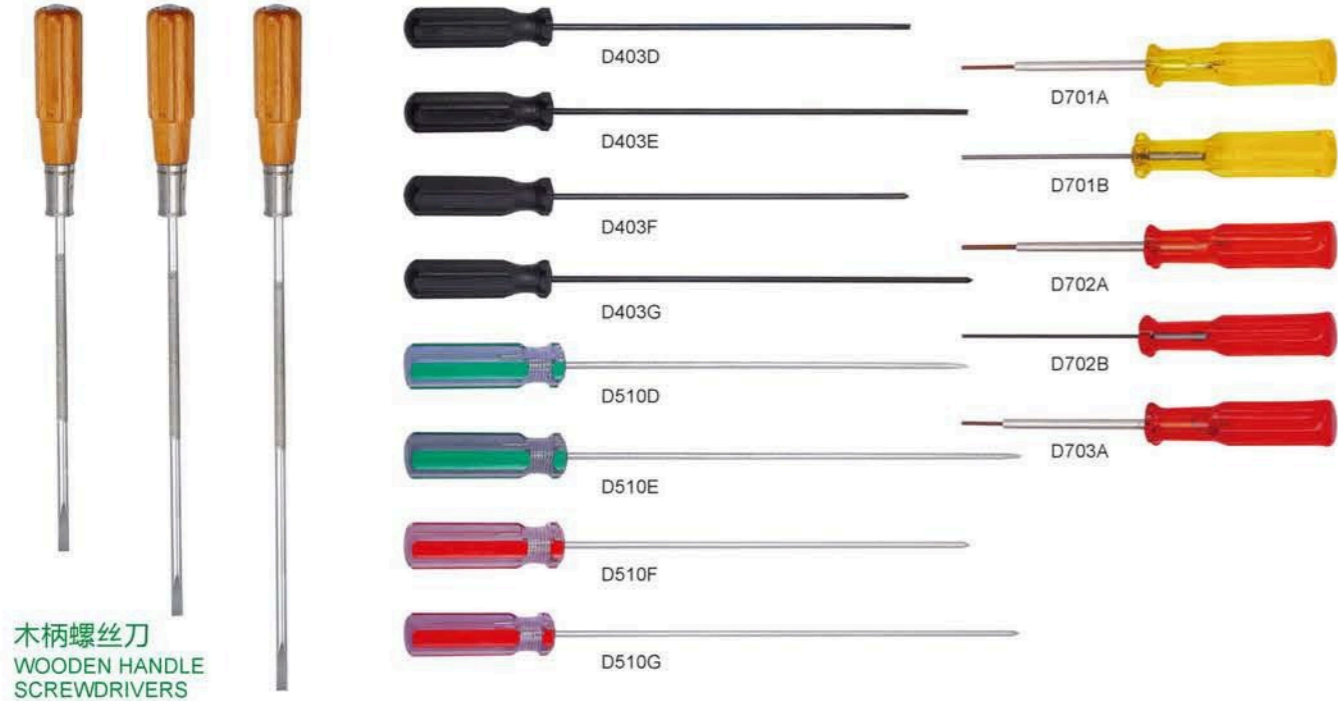

木柄螺丝刀  
WOODEN HANDLE  
SCREWDRIVERS

OIL BOTTLE 油瓶系列



### BEST NEEDLE 精品机针



规格表 / SPECIFICATION

型号 model	规格 Specification
DB×1 69×1 1738	60-70
	75-85, 120-140
	90-110
DB×K5	60-70
	75-85
	90-110
DP×5 135×5 SY1901	60-70
	75-85, 120-140
	90-110
	160-200
DC×1 81×1 621	60-70
	75-85, 120-140
	90-110
DC×27 B-27 MY1023	60-70
	75-85, 120-140
	90-110
DP×17 135×17 SY3355	65-70
	75-85, 120-140
	90-110
	160-200
UY128GAS DV×43 GK×1	60-70
	75-85, 120-140
	90-110
DV×1 UY121GS SY3510	60-70
	75-85, 120-140
	90-110

注：球款另外订购 Note: KN type need to order.

### PLASTIC PLATE NEEDLE 塑料板机针



规格表 / SPECIFICATION

型号 model	规格 Specification
DB×1 69×1 1738	60-70
	75-85, 120-140
	90-110
DB×K5	60-70
	75-85
	90-110
DP×5 135×5 SY1901	60-70
	75-85, 120-140
	90-110
	160-200
DC×1 81×1 621	60-70
	75-85, 120-140
	90-110
DC×27 B-27 MY1023	60-70
	75-85, 120-140
	90-110
DP×17 135×17 SY3355	65-70
	75-85, 120-140
	90-110
	160-200
UY128GAS DV×43 GK×1	60-70
	75-85, 120-140
	90-110
DV×1 UY121GS SY3510	60-70
	75-85, 120-140
	90-110

注：塑盒包装另外订购 Note: Plastic package need order.

FLYING TIGER NEEDLE 飞虎机针



规格表 / SPECIFICATION

型号/Model	规格/Specification	型号/Model	规格/Specification	型号/Model	规格/Specification	
DB×1 96×1 1738	50-55#	GK16×1 DV×63 B-63	60-70#	566×1 (平面Plane) TQ×7 175×7	65-70#	
	60-70#		75-85#		75-80#	
	75-85#		90-110#		90-110#	
	DC×1 81×1 621	90-110#	UY128GAS GK27×1 DV×43 SY7292	60-70#	DM13×1 DM×13	120-140#
		120-140#细 Fin		75-80#		75-80#
		120-140#粗 Coarse		90-110#		90-110#
160-200#		120-140#		60-70#		
DC×27 B-27 MY1023	60-70#	121×1 DV×1 UY121GS	65-70#	TV×7 135×7	75-80#	
	75-85#		75-80#		75-80#	
	90-110#		90-110#		90-110#	
	120-140#		120-140#		120-140#	
DP×5 135×5 SY1901	65-70#	GR2-2×1 DP×17 135×17 SY3355	65-70#	44×1 16×1 TF×1	90-110#	
	75-85#		75-80#		120-140#	
	90-110#		90-110#		160-180#	
	120-140#		120-140#		65-70#	
DB×K5	160-200#	15×1 HA×1	75-85#	88×1	75-85#	
	60-70#		90-110#		90-110#	
	75-85#		120-140#		65-70#	
	90-110#		120-140#		65-70#	
DO×5	566×1 (四眼Four eyes)	566×1 (四眼Four eyes)	75-85#	303×1 UO113GS UY113GS	230-300#	
	TQ×1		90-110#		380-400#	
	175×1		120-140#		230-250#	
	DO×5		90-110#		160-250#	
				45×1 DD×1	200-250#	
				7×1 DY×1		

DOTEC NEEDLE 多特机针



规格表 / SPECIFICATION

型号/Model	规格/Specification	型号/Model	规格/Specification
多特机针 DOTEC NEEDLE	DB×1	多特机针 DOTEC NEEDLE	UY128GAS
	DP×5		UY118GAS
	DB×K5		MT×190
	DC×1/DC×27		EB×1
	DO×5		EB×755
	DO×558		SM×1014B
	DP×17		TQ×1
	DV×57		TQ×7
	LW×2T/LW×6T		TV×1/TV×5/TV×64
	UO×113GS		TV×7
UO×163			

注：同种型号的普通针、KN、BP 针为同一价格，8#以上机针均为同一价格，7#机针另加价，134类24#另加价30%。  
Note: For same type needle, KN&BP have same price, 8# and bigger than 8# have same price, 7# and 134type 24#is expensive than 8#, need to check.

# GRAVITY FEED IRON SERIES

## 吊瓶熨斗系列

无需蒸汽发生器,可在仅提供电源的条件下轻便地使用  
(适合与小型工厂,装饰品及服装工厂)

Steam generator is not required\* You can easily start ironing wherever you want if only electric power supply is available. it is applicable for small garment factories, boutiques and also laundry shop.



### UN-300L

分体式/一体式 Split type/One-body

电压 Model	220V
重量 Weight	2.6Kg
功率 Power	分体式1450W 一体式1200W
底板尺寸 Bottom size	227×138mm

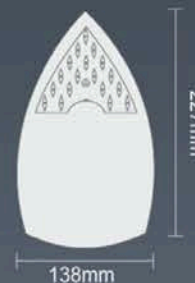

### UN-3300

电压 Model	220V
重量 Weight	2.6Kg
功率 Power	1300W
底板尺寸 Bottom size	227×138mm



### UN-1300M

电压 Model	220V
重量 Weight	2.6Kg
功率 Power	1100W
底板尺寸 Bottom size	195×65mm



### UN-94B

电压 Model	220V
重量 Weight	2.1Kg
功率 Power	1200W
底板尺寸 Bottom size	209×120mm

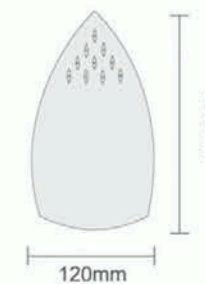

### UN-530

电压 Model	220/110V
重量 Weight	2.12Kg
功率 Power	1000W
底板尺寸 Bottom size	204×114mm

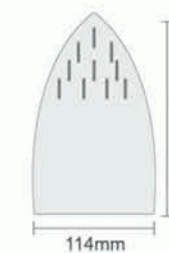



**UN-533**

电压 Model	220/110V
重量 Weight	2.12Kg
功率 Power	1100W
底板尺寸 Bottom size	227×138mm

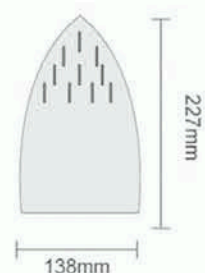

**UN-550**

电压 Model	220V
重量 Weight	2.1Kg
功率 Power	1200W
底板尺寸 Bottom size	209×120mm

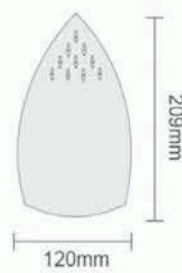

**UN-520**

电压 Model	220/110V
重量 Weight	2.12Kg
功率 Power	1000W
底板尺寸 Bottom size	204×114mm

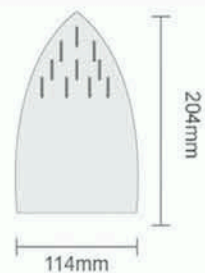

**UN-94AL**

电压 Model	220V
重量 Weight	2.6Kg
功率 Power	1200W
底板尺寸 Bottom size	227×138mm



**UN-94A**

电压 Model	220V
重量 Weight	2.1Kg
功率 Power	1000W
底板尺寸 Bottom size	209×120mm

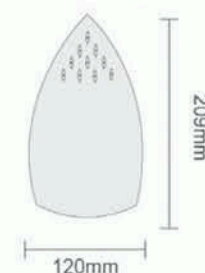

**UN-96B**

电压 Model	220V
重量 Weight	2.3Kg
功率 Power	1200W
底板尺寸 Bottom size	205×113mm



**UN-300**

电压 Model	220V
重量 Weight	2.1Kg
功率 Power	1000W
底板尺寸 Bottom size	209×120mm

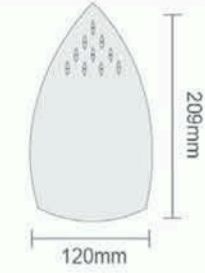

**UN-85AF**

电压 Model	220V
重量 Weight	2.4Kg
功率 Power	1000W
底板尺寸 Bottom size	210×120mm





UN-787

电压 Model	220V
重量 Weight	2.1Kg
功率 Power	1200W
底板尺寸 Bottom size	209×118mm

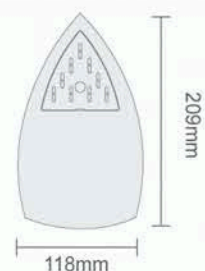

UN-99B

电压 Model	220V
重量 Weight	2.14Kg
功率 Power	1450W
底板尺寸 Bottom size	194×127mm

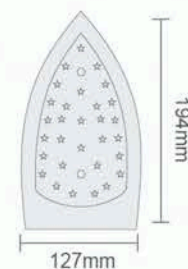

UN-777B

电压 Model	220V
重量 Weight	2.1Kg
功率 Power	1200W
底板尺寸 Bottom size	207×117mm



UN-300B

电压 Model	220V
重量 Weight	2.2Kg
功率 Power	1200W
底板尺寸 Bottom size	205×118mm

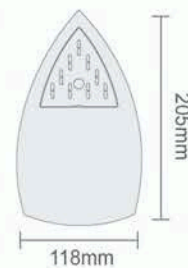

UN-2128

电压 Model	220/110V
重量 Weight	2.26Kg
功率 Power	900/800W
底板尺寸 Bottom size	198×117mm

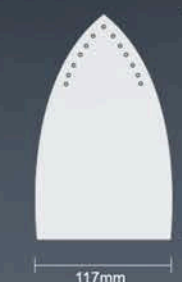

ELECTRIC STEAM  
IRON SERIES  
电加热熨斗系列

无需蒸汽发生器,可在仅提供电源的条件下轻便地使用  
(适合与小型工厂,装饰品及服装工厂)

Steam generator is not required\* You can easily start ironing wherever you want if only electric power supply is available. it is applicable for small garment factories, boutiques and also laundry shop





UN-0010

电压 Model	220/110V
重量 Weight	2.2Kg
功率 Power	900/800W
底板尺寸 Bottom size	200×116mm

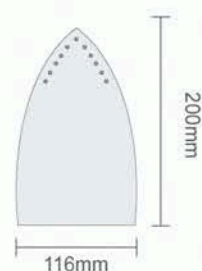

UN-B-200

电压 Model	220/110V
重量 Weight	2.33Kg
功率 Power	900/800W
底板尺寸 Bottom size	224×121mm

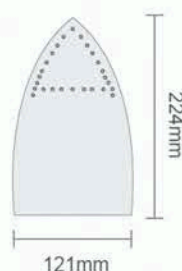

UN-1000

电压 Model	220/110V
重量 Weight	1.17Kg
功率 Power	900/800W
底板尺寸 Bottom size	186×105mm

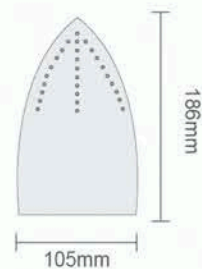

UN-0001

电压 Model	220/110V
重量 Weight	2.6Kg
功率 Power	900/800W
底板尺寸 Bottom size	219×118mm

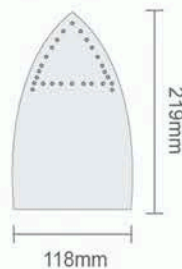

UN-B8T

电压 Model	220V
重量 Weight	2.5Kg
功率 Power	1000W
底板尺寸 Bottom size	214×144mm

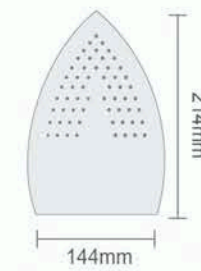

UN-2000

电压 Model	220V
重量 Weight	1.9Kg
功率 Power	1000W
底板尺寸 Bottom size	180×106mm



UN-360 皮革专用  
For leather

电压 Model	220V
重量 Weight	2.1Kg
功率 Power	1400W
底板尺寸 Bottom size	207×117mm

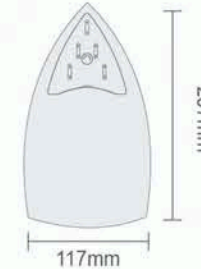

UN-820 工业贴木皮专用  
For industrial veneer

电压 Model	220V
重量 Weight	1.65Kg
功率 Power	1400W
底板尺寸 Bottom size	248×115mm

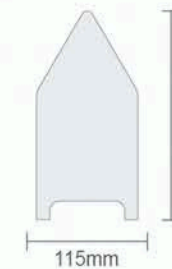

# ALL STEAM IRON SERIES

## 全蒸汽熨斗系列

- 1.汽水分离装置,节能30%-40%以上,寿命是普通疏水阀的10倍以上。
  - 2.蒸汽均匀,汽量更大,熨斗底板只出干燥蒸汽,完美解决熨烫衣服时出现的黄斑、水渍问题。
  - 3.熨斗尾部回气管蒸汽全部收回在熨斗内部循环利用,只排水不跑蒸汽。
  - 4.双重焊接工艺,不易变形,持久更耐用。
1. Our patent steam trap can save 30%-40% energy, 10 times longer service life than regular steam trap.
  2. More Steam vapor evenly, dry steam only, perfect solution of the dirty spot and water stain problem during ironing.
  3. Steam regenerator recycles inside the iron chamber all the time and discharges water only.
  4. Double welding process, no deformation on base, more durable.



UN-17

节能型全蒸汽熨斗  
Energy saving full steam iron

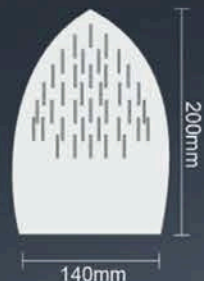



蒸汽调节器控制蒸汽。由蒸汽发生器经蒸汽管道SE-2000的流量  
Steam volume is controlled by the steam generator through a steam pipeline flow of SE - 2000



**UN-3**  
电压 Model 220/110V  
重量 Weight 1.1Kg



**UN-5**  
电压 Model 220/110V  
重量 Weight 1.1Kg

**可选配件/ OPTIONAL ACCESSORIES**

**蒸汽管保护套 Steam hose cover**

用途: 使蒸汽管不易受折, 延长其寿命。  
使用方法: 只需要在使用时将蒸汽管保护套套在蒸汽管外即可。  
Application method: put on outside of steam hose when using it.



**可选配件/ OPTIONAL ACCESSORIES**

**熨斗隔热板 Iron rest**

用途: 耐高温, 在熨斗加热过程或使用过程中搁置用。  
Usage: \*Heat-resistant, Iron rest is used for placing iron during or in the process of use.



# ALUMINUM IRON SHOE SERIES

## 铁氟龙熨斗靴系列

- 1、优质铝材更耐热，使用温度高达260°C；
- 2、采用铁氟龙材料制作，特别耐用；
- 3、最适合人造纤维制品使用；
- 4、采用多型铝框及无铝框设计，适合多种烫斗使用；
- 5、烫斗底部气孔特多，使蒸汽能穿过气孔平均地散布在衣物上。

1. High quality aluminum is more heat resistant, the use of temperature up to 260 C.
2. Made of PTF material, especially durable.
3. The most appropriate use of making fiber goods.
4. Multi-model aluminum frame and non-frame design are suitable for many kinds of irons.
5. The bottom of iron has multiple holes, steam will flow through and spread on clothes equably.

### 有多种耐高温隔热布条供选择：

硅胶条、白色耐高温布条、普通布条。  
使用寿命长、轻巧灵便、熨烫后的衣物不发亮，  
依旧保持其完美。

Iron shoes provides your iron with safer protection and to last longer, which is light to use without shiny effects on fabrics.  
Silicon belt, white heat-resistant cloth strip and ordinary strip are available to choose from.

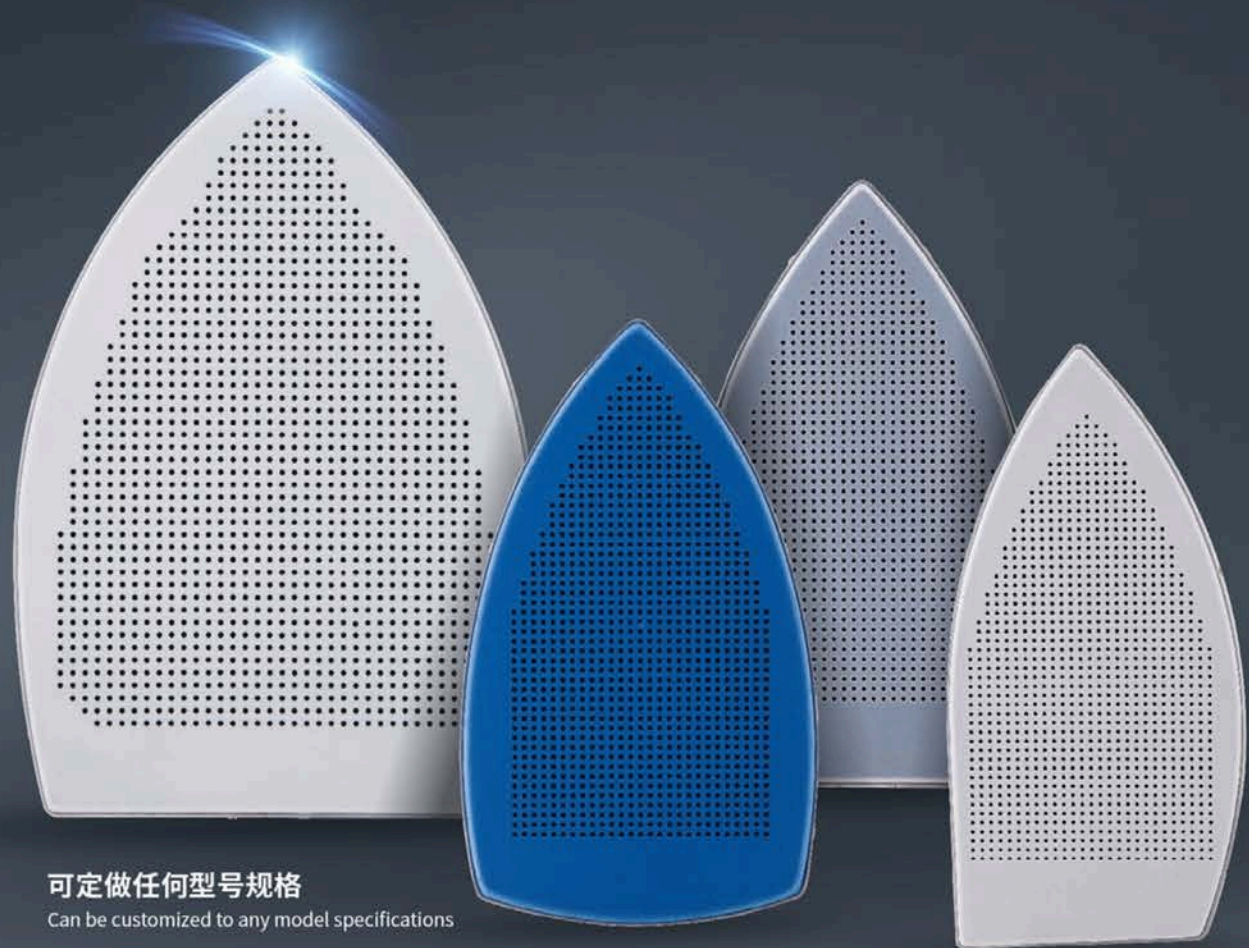

可定制任何型号规格  
Can be customized to any model specifications

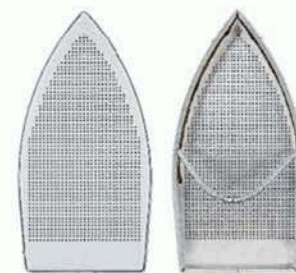

SP-420/BSP-300/HS-410P/TF-400P

01 206×103mm

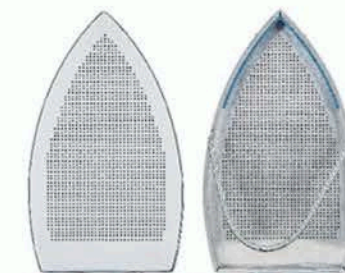

IRON MASTER/ST-SOM/STB-250/DUE-EFFE

02 208×121mm

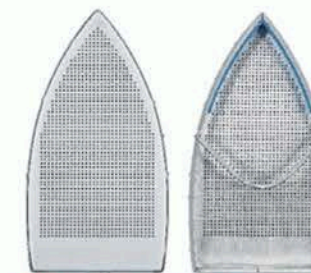

SH-350/HASHIMA-350

03 206×109mm

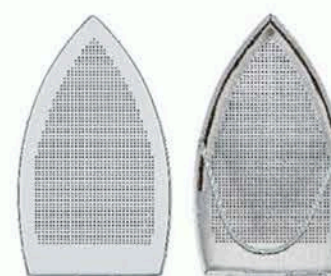

CISSELL-68/TULIPANO

04 205×113mm

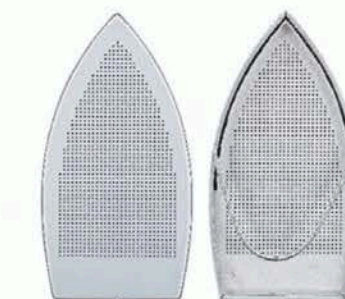

MAXI LEMM

05 235×120mm

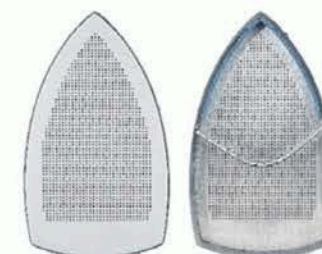

ES-85-AF/ES-300/ES-94A/  
ES-94/ES-200/ESB-75

06 212×122mm

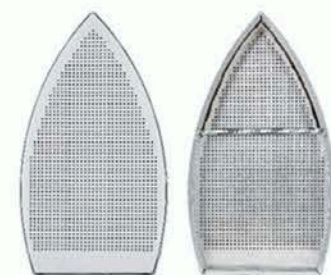

CISSELL-ACT-800

07 193×106mm

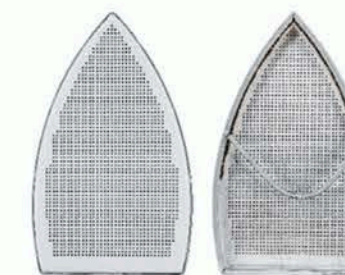

SE-2000

08 185×110mm



HS-300P

09 198×63mm



BSP-200

10 192×61mm

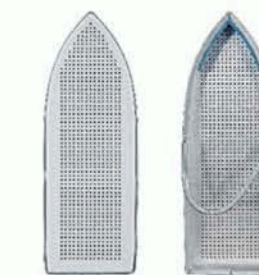

BS-2PC

11 194×64mm



BS-3PC

12 194×112mm



UN-2  
13 195×47mm

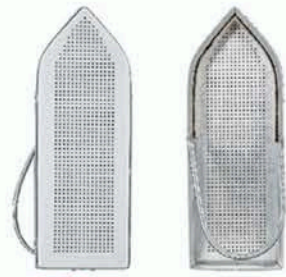

UN-1  
14 195×67mm

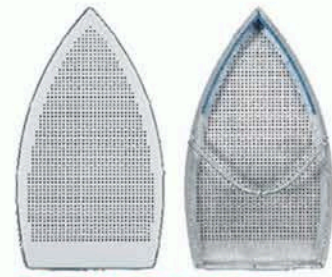

TF-1000/CISSELL-1000  
15 195×107mm

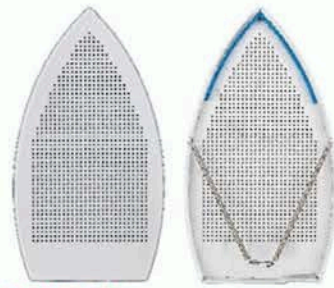

336.NPG.SL  
16 213×115mm

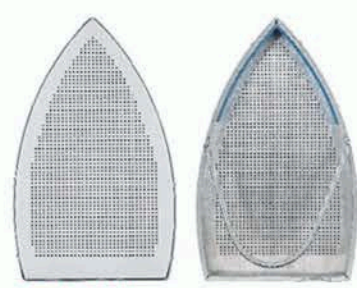

CISSELL-67  
17 195×118mm

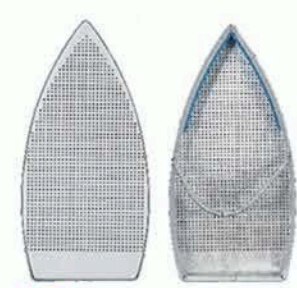

HS-5  
18 195×95mm



HS-1  
19 199×113mm

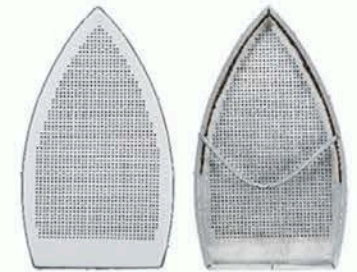

SE-850  
20 200×115mm

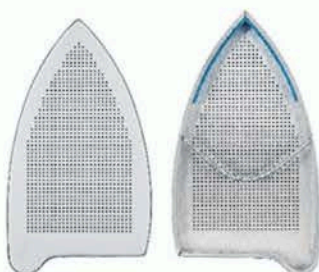

LEMM  
21 200×118mm

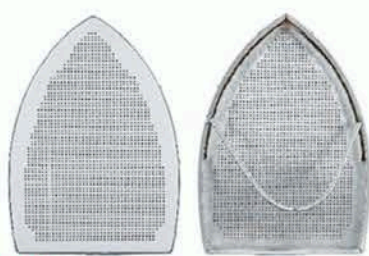

HS-6  
22 201×145mm



COMEL SMALL  
23 202×119mm

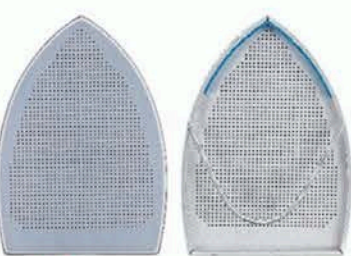

UN-6  
24 202×144mm

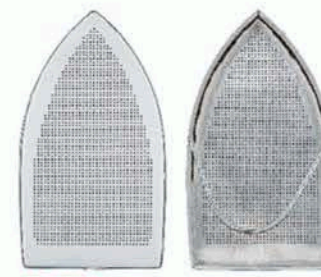

SH-555  
25 216×118mm



B-6-T  
26 204×101mm

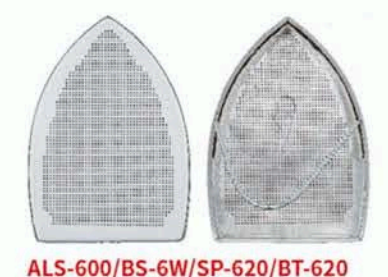

ALS-600/BS-6W/SP-620/BT-620/ASL-620  
27 204×145mm

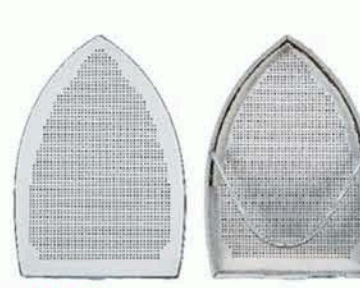

ADL-610  
28 205×144mm

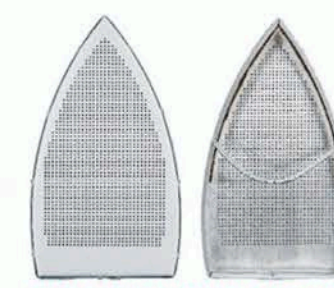

SH-550/HASHIMA-550/ST-60M  
29 206×115mm

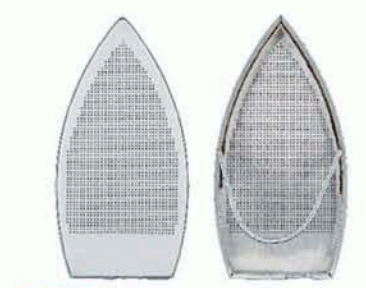

TCM-608  
30 218×108mm



HYS-6  
31 207×108mm

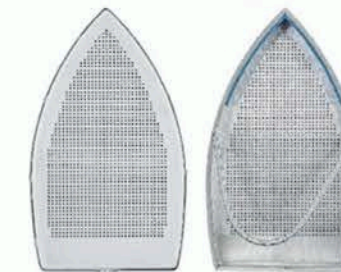

520/ES-3100  
32 207×120mm

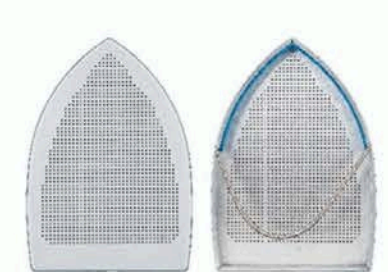

ASL-610  
33 207×146mm

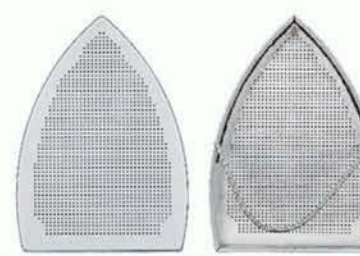

BS-6PC/BS-6SC/BSS-600  
34 207×150mm



VEIT-2128  
35 207.5×121mm

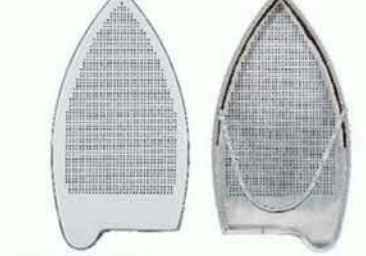

TV-3/TREVIL  
36 208×117mm

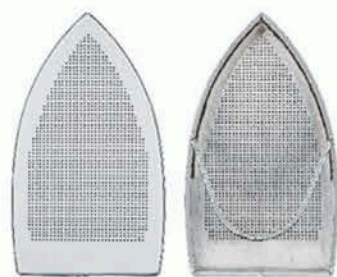

**SH-111**  
37 208×120mm

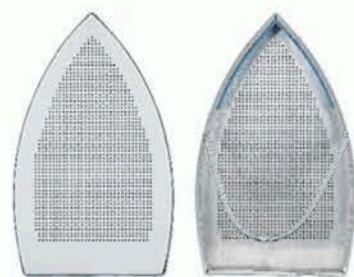

**ASL-50.S**  
38 212×127mm

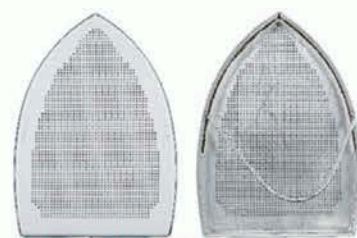

**ASL-60S/TAIWAN 1**  
39 209×152mm

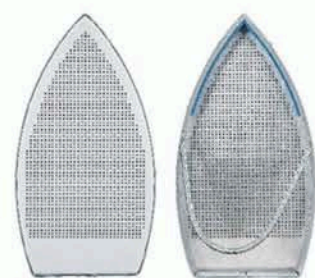

**HYS-5/IS-7151**  
40 211×109mm

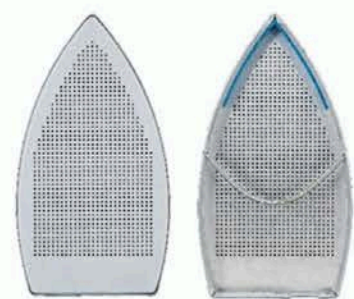

**STB-275**  
41 208×110mm



**SB-320**  
42 213×70mm



**SE-110**  
43 213×117mm



**SE-90/SE-900**  
44 214×115mm

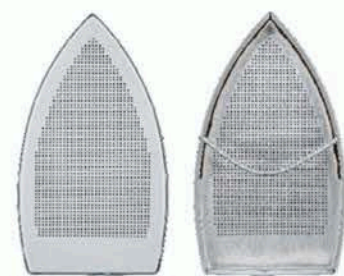

**SA-120/SA-120A/COVENMAT(F2)**  
45 214×121mm



**CV-90TREVIL**  
46 215×120mm

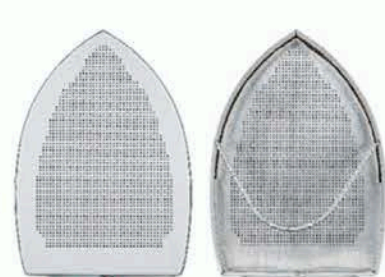

**ASL-630**  
47 215×153mm



**COVENMAT(F1)**  
48 218×122mm

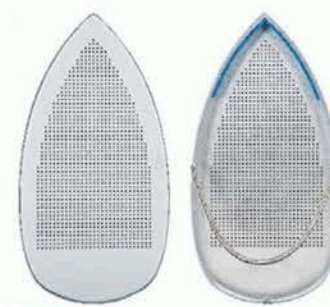

**巴西7480**  
49 243×123mm

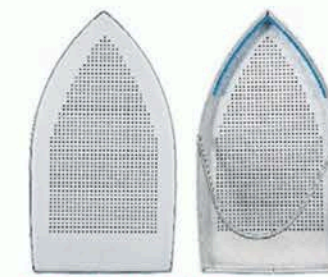

**TIS-A/SHELDON-555**  
50 220×121mm

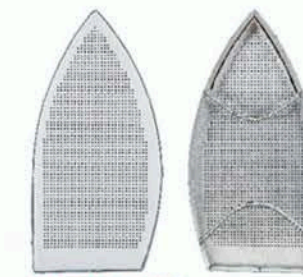

**VEIT-H.D.2000**  
51 221×107mm



**P23**  
52 225×118mm

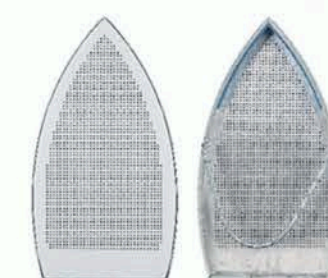

**SEM1-2**  
53 227×125mm

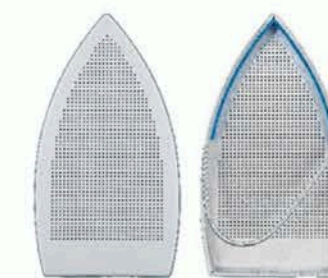

**STB-200**  
54 228×123mm

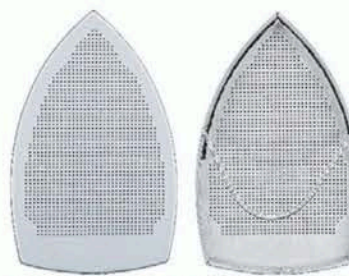

**ES-94AL/ES-100-AF/ES-300L**  
55 228×144mm

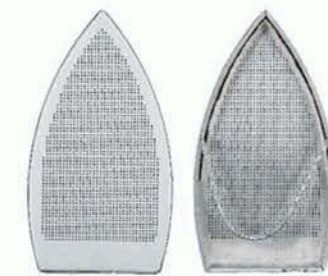

**TS-BDI**  
56 229×125mm

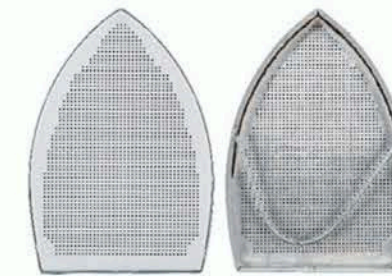

**HS-600A**  
57 198×137mm

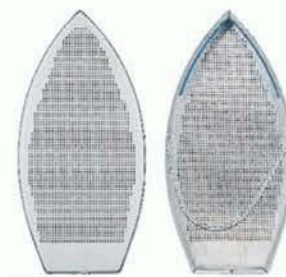

**ISRAEL**  
58 237×113mm

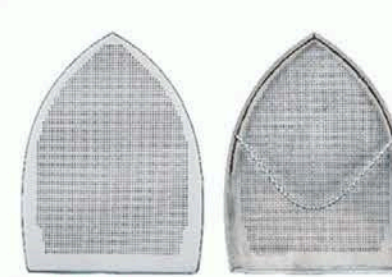

**UN-D**  
59 240×182.5mm

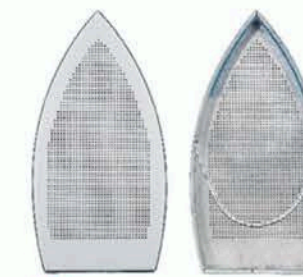

**M-5**  
60 243×122mm

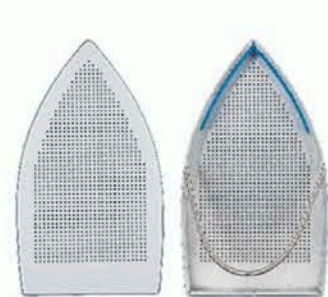

**ST-96**  
61 201×113mm

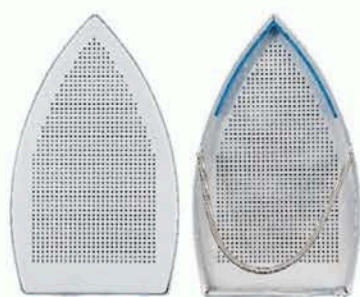

**TULIPANO**  
62 199×118mm

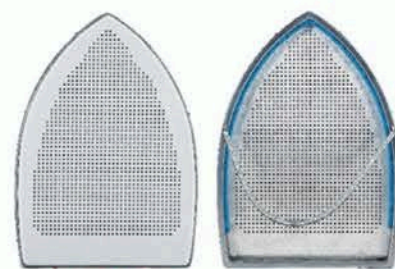

**ASL-610钢网**  
63 204×145mm

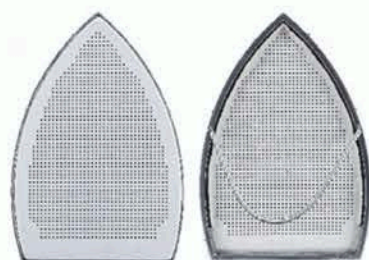

**B-8TN钢网**  
64 210×145mm



**ES-85-AF钢网**  
65 212×122mm



**STB-295**  
66 189×52mm

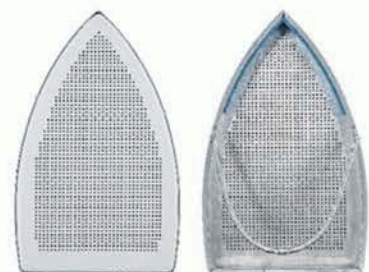

**UN-9000**  
67 196×121mm

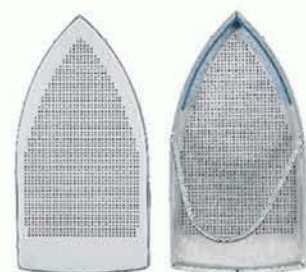

**CL-2668**  
68 196×121mm

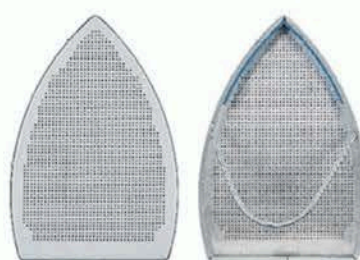

**B8-2**  
69 207×137mm

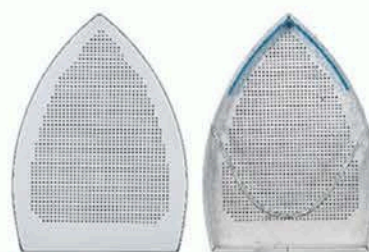

**UN-890**  
70 200×148mm

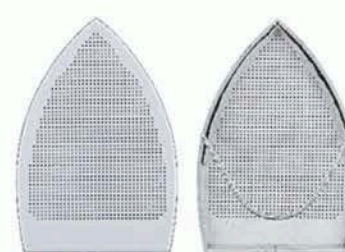

**B-8TN**  
71 212×142mm

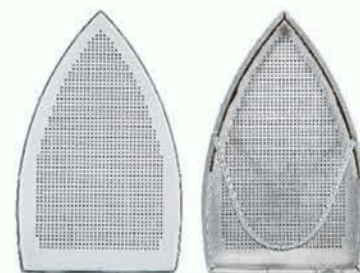

**SE-800/NEW-B63**  
72 196×121mm

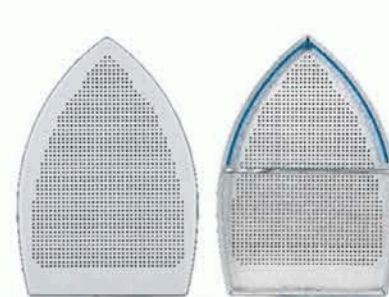

**UN-17**  
49 202×139mm



**UN-82**  
50 213×110mm



**UN-83**  
51 214×112mm

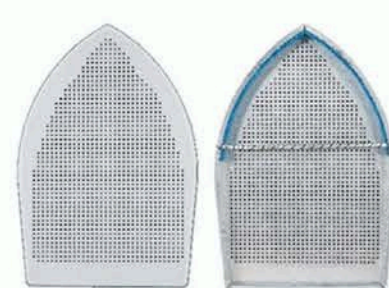

**UN-99B**  
52 193×131mm

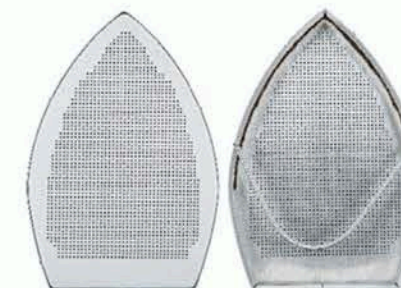

**UN-125**  
53 213×145mm



**HK-2128**  
54 223×125mm



1



2



3



4



5



6



7



8



9



**特氟龙原子喉 Teflon Steam Hose**

1. 可选择以英尺为单位的非常尺寸 (6、7、8英尺)。
2. 每种产品订购2000条以上者, 可要求特殊颜色与长度。
3. 铁氟龙原子喉采用新四氟材料P.F.A, 抗挠性好, 耐热性能高, 使用寿命长。即使反复弯曲, 也能很好的复原。结实、经久、耐用。
4. 成份: 三层棉纱, 二层不锈钢丝, 一层工业丝编织。
5. 工业丝特点: 耐高温, 可在150°C至250°C之间使用, 色彩鲜艳。
6. 标准长度: 2.0m、2.5m、3.0m、3.5m、4.0m。
7. 颜色: 1.黄色 2.绿色 3.天兰 4.深蓝 5.白色。
8. 特殊要求规格: 可定做。
9. 包装规格: 60根/箱(2.0m,2.5m,3.0m)50根/箱(3.5m,4.0m)

1. Teflon steam hose: special size available(6/7/8feet).
2. If the order is more than 2000 pieces, customer is allowed to choose special color and length.
3. Teflon steam hose uses new material P.F.A, with good flexibility, high heat-resistant, and long durable life. It can recover even after many times of bending.
4. Composition of 3-layer cotton yarn, 2-layer stainless steel wire and 1-layer industrial wire.
5. Feature of industrial wirer: high heat-resistant ,can be used between 150°C and colorful choices.
6. Standard length: 2.0m 2.5m 3.0m 3.5m 4.0m.
7. Color: 1.yellow 2.green 3.sky blue 4. dark blue 5. white.
8. requested spec: made-to-order.
9. Packing spec: 60/box(2.0m.2.5m.3.0m)50/box(3.5m.4.0m).



**化水器 Steam Trap**

化水器能消除全蒸汽熨斗在使用中滴水的现象, 排除水份, 不浪费蒸汽, 节约能源, 效果明显。使用简单, 安装方便。

Our patented steam trap can solve the dripping water problem of all-steam Iron. It saves energy by draining off water without wasting steam, which is easy to use and convenient to install.

**熨斗隔热板 Iron Rest**



**熨斗零配件 Iron Spare Parts**



### 熨斗零配件 Iron Spare Parts



手柄-1  
Iron Handle-1



手柄-2  
Iron Handle-2



520调温器  
Thermostat



94A调温器  
Thermostat



UN-Z1



发热板  
UN-B-200 Heater



发热板  
UN-0001 Heater



熨斗外壳  
Iron Husk



硅胶管  
Silicon Hose

### 锅炉零配件 Boiler Spare Parts



蒸汽安全阀-2  
Safety Valve-2



蒸汽安全阀-3  
Safety Valve-3



蒸汽安全阀-4  
Safety Valve-4



压力开关  
Pressure Switch



UN-2035安全阀  
UN-2035 Safety Valve



UN-2035压力表  
UN-2035 Pressure Gauge



UN-2035电磁阀  
UN-2035 Valve



自动恒温器  
Automatic Thermostat



锅炉阀门  
The valve of the boiler



锅炉开关  
Boiler switch



锅炉开关  
Boiler switch

### 其他零配件 Other spare parts



UN-FQ



粘合机450胶筒  
Rubber Tube



开条机刀片  
UN-911A Blade



开条机刀片  
UN-801A Blade



开条机刀片  
UN-802A Blade



调速器  
Speed Regulator



40A固态继电器  
Solid State Relay



烫画机接触器  
Heat Press Machine  
Contactor



烫画机温控器  
Heat Press Machine  
The thermostat



450电脑板  
PC board



450热电偶  
Thermocouple



温度传感器  
Temperature sensor



450微动开关  
Micro switch



52P继电器  
Relay



450电位器  
potentiometer

ALUMINUM IRON SHOE 铁氟龙熨斗靴

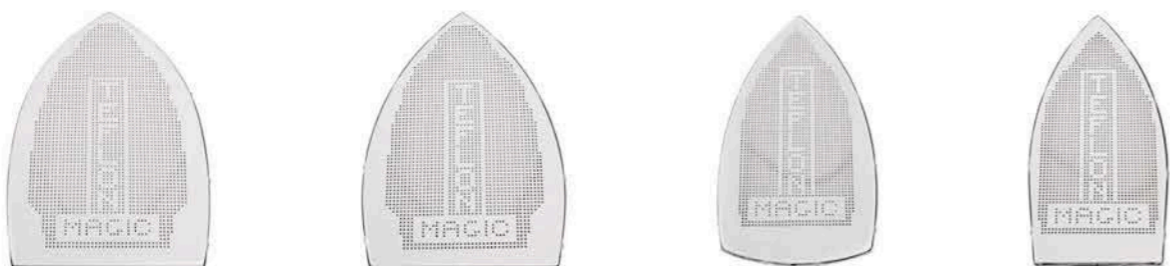

规格表 / SPECIFICATION

型号 MODEL	尺寸 SIZE	配套 MATING	型号 MODEL	尺寸 SIZE	配套 MATING
SP-420	206mm×103mm	ZJ-QY410	BSP-200	192mm×61mm	ZJ-QY200
BS-3PC	194mm×112mm	ZJ-QY603	BS-6PC	207mm×150mm	ZJ-QY606-1/2 ZJ-QY-608
ASL-60S	209mm×152mm	ZJ-QY600	ES-85-AF	212mm×122mm	ZJ-DY777,787,797,676,686
890		ZJ-QY890	TF-1000	195mm×107mm	

SANJIAODAI RUBBER 三角皮带



特点:

1. 窄V型的紧凑结构,更节省空间,传递马力更大。
2. 高速防油,耐磨织布外包带体,使得皮带寿命更长久。
3. 芯线抗张力强,不易伸长。比传统A\B\C\D型带的传递效率更高。

FEATURES:

1. The Narrow V shape compact structure can saving more space, make the motor more horsepower.
2. High-quality basmas compound protects the belt against oil, make the life for belt more longer.
3. "Flex-bonded" tensile cords are vulcanised as one solid unit making the belt highly resistant to tensile and flexing forces, fatigue and shock loads.

规格表 / SPECIFICATION

名称 Name	规格 Specification	名称 Name	规格 Specification	名称 Name	规格 Specification	名称 Name	规格 Specification
三角带 Sanjiaodai rubber	M-32	三角带 Sanjiaodai rubber	M-36	三角带 Sanjiaodai rubber	M-40	三角带 Sanjiaodai rubber	M-46
三角带 Sanjiaodai rubber	M-33	三角带 Sanjiaodai rubber	M-37	三角带 Sanjiaodai rubber	M-41	三角带 Sanjiaodai rubber	M-49
三角带 Sanjiaodai rubber	M-34	三角带 Sanjiaodai rubber	M-38	三角带 Sanjiaodai rubber	M-42	三角带 Sanjiaodai rubber	M-52
三角带 Sanjiaodai rubber	M-35	三角带 Sanjiaodai rubber	M-39	三角带 Sanjiaodai rubber	M-44	三角带 Sanjiaodai rubber	M-55

TEFLON STEAM HOSE 铁氟龙原子喉胶管



特点:

1. 铁氟龙原子喉采用新四氟材料P.F.A, 抗挠性好, 耐热性能高, 使用寿命长。即使反复弯曲, 也能很好的复原。结实、经久、耐用。
2. 成份: 三层棉纱, 二层不锈钢丝, 一层工业丝编织。
3. 工业丝特点: 耐高温, 可在150°C至250°C之间使用, 色彩鲜艳。
4. 标准长度: 3.0m
5. 颜色: 金黄色\湖蓝\深蓝\黑色
6. 包装规格: 50根/箱

FEATURES:

1. Teflon steam hose uses new material P.E.A. with good flexibility, high heat-resistant, and long life. It can recover even after many many times of bending. It's strong, long-life, and durable.
2. Composition 3-layer cotton yarn, 2-layer stainless steel wire, 1-layer industrial wire.
3. Feature of industrial wirer: high heat-resistant, can be used between 150°C, colorful.
4. Standard length: 3.0m
5. Color: yellow\Lake blue\dark blue\black
6. Packing spec 50/box

规格表 / SPECIFICATION

型号 Model	名称 Name	颜色 Color	长度(米) Length (m)	备注
UN-JGS-5000	硅胶散管5mmX9mm/6mmX11mm Silicone scattered tube	黄色 Yellow	50	
UN-JG-1003	硅胶中压管5mmX9mm Silicone medium-voltage tube	深蓝色 Dark blue	3	
UN-JG-2003	铁氟龙高压管F46 Teflon high-pressure tube	湖蓝色 Lake blue	3	不带接头 With out joins
UN-JG-3003	铁氟龙高压管 F46 Teflon high-pressure tube	湖蓝色 Lake blue	3	带接头 With joins
UN-JG-4003	铁氟龙高压管 PTFE Teflon high-pressure tube	金黄色 Golden	3	不带接头 With out joins
UN-JG-5003	铁氟龙高压管 PTFE Teflon high-pressure tube	金黄色 Golden	3	带接头 With joins
UN-JG-6003	接头可重复使用型高压管 Joint reusable type hose	黑色 Black	3	不带接头 With out joins
UN-JG-7003	接头可重复使用型高压管 Joint reusable type hose	黑色 Black	3	带接头 With joins

注: UN-JG-1003/3003/4003/5003/6003/7003, 规格可订制5米。Can order 5m.

UN-MDK-60



**通用型包缝车用送带机**  
 底座固定于车板上送料宽度50mm  
**For general overlock machines**  
 Base is mounted on the table with 50mm wide roller

UN-MDK-61



**专用型包缝车用送带机**  
 底座固定于机头上送料宽度50mm  
**For specified overlock machines**  
 Base is mounted on the machine head with 50mm wide roller

UN-MDL-31



**高速曲折缝机用送带机**  
 ZJ-MDL-30 底座固定于车板上  
 ZJ-MDL-31 底座固定于机头上  
**Metering device For zigzag machines**  
 ZJ-MDL-30 Base is mounted on the table  
 ZJ-MDL-31 Base is mounted on the machine head

UN-TFS-25-3



**侧送型送料机，送料宽度70mm**  
 机械式、上下抖动防打结装置  
**Side tape feeder, with 70mm wide roller**  
 Mechanical untangling device with up & low dithering

UN-TFU-15-3



**上机型送料机，送料宽度70mm**  
 机械式防打结装置  
**Upper tape feeder with 70mm wide roller**  
 Mechanical untangling device

UN-PL



**单针、双针专用**  
 具有多种选择性拖轮，能适应不同面料之车缝具有宽广操作空间  
**For single or twin needles machines**  
 With various optional rollers for sewing materials maximum space for sewing operation

UN-PS

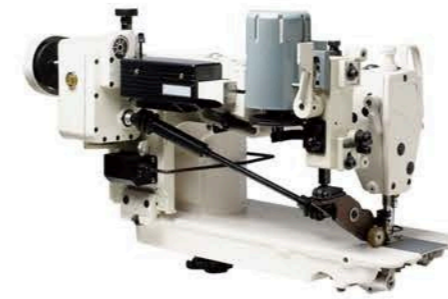

**小轮平车专用**  
 拖轮与车针距离越近，适合薄物，短距离及弯弧车缝  
 拖轮不用时，可以提升抬起  
**Small roller for flat sewing machines only**  
 Close pulling facilitates curve & short sewing on light materials  
 Disengage roller if not needed

UN-PL-S2



**筒型饰缝车用**  
**For cylinder bed coverstitch**

UN-PF



**碗型针车用**  
 具有多种选择拖轮能适应不同面料的车缝  
**For feed-off-arm**  
 With various optional rollers for all kinds of sewing materials

UN-PK



**包缝车用、上下轮驱动**  
 可下沉式使用  
**For overlock with upper and lower roller**  
 Can be used to submerge

UN-PT



**单针、双针车用、上下轮驱动**  
**For single or twin needles with upper and lower (roller)**

UN-PY



**单针、双针车用**  
 上下轮驱动，拉力特强可下沉式使用  
**For single or twin needles or other special machines**  
 Powerful upper and lower drive rollers can be used to submerge

# TOPDIS

## PULLER ATTACHMENT 拖轮组系列

UN-PL-L(气动款)  
(Pneumatic type)



同步牵引装置(加长平车, 长臂车用)  
Synchronous draw gear (For Long, Arm Machine)

UN-PL-L(电磁铁款)  
(Electromagnet type)



同步牵引装置(加长平车, 长臂车用)  
Synchronous draw gear (For Long, Arm Machine)

UN-PY-SP



同步牵引装置(前拉式, 单针车, 绷缝车, 高速折缝意大利面专用)  
Synchronous draw gear (Front Puller for Single Needle Machine, Coverstitch, Zigzag Machine, for Spaghetti Sewing)

UN-PK-SP

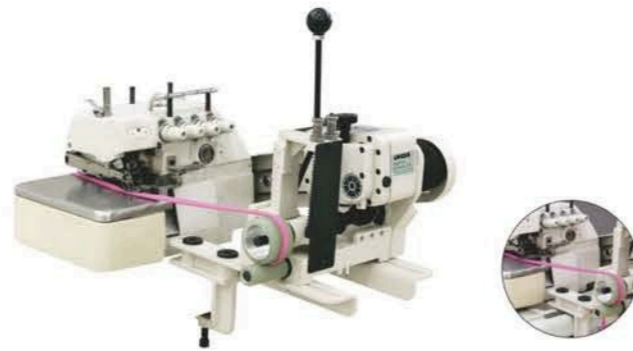

同步牵引装置(前拉式包缝车意大利面专用)  
Synchronous draw gear (Front Puller for Spaghetti Sewing)

UN-PK-L



同步牵引装置(多针车、绷缝车用)  
Synchronous draw gear (For multi-needle and coverstitch sewing machine)

UN-PG



同步牵引装置(包缝车用, 小轮, 薄料)  
Synchronous draw gear (For Overlock Machine, Small Roller)

# TOPDIS

## PULLER ATTACHMENT 拖轮组系列

UN-PL-S1



同步牵引装置(绷缝车用)  
Synchronous draw gear (For Coverstitch Machine)

UN-PL-S2



同步牵引装置(筒型饰缝车用)  
Synchronous draw gear (For Cylinder Bed Coverstitch Machine)

(气动款)  
(Pneumatic type)



同步牵引装置(电子拖轮)  
Synchronous draw gear (Electronic tug)

(电磁铁款)  
(Electromagnet type)



同步牵引装置(电子拖轮)  
Synchronous draw gear (Electronic tug)

UN-TK



同步牵引装置(简易式拖轮)  
Synchronous draw gear (Simple Type Puller)



毛毯同步拖轮(飞马W500专用型大针具拖轮)  
Carpet Puller (For Pegasus W500)

# TOPDIS

## PULLER ATTACHMENT 拖轮组系列

UN-MDL30



同步送带装置(平车、双针、绷缝机用)  
Synchronous tape feeder(For Single, Twin needle, Coverstitch, Special Machine)

UN-MDL31



同步送带装置(平车、双针、绷缝机用)  
Synchronous tape feeder(Meteeing Device for Zigzag Machine)

UN-MDL31



同步送带装置(下送型)  
Synchronous tape feeder(Down feed)

UN-MDL31-W500

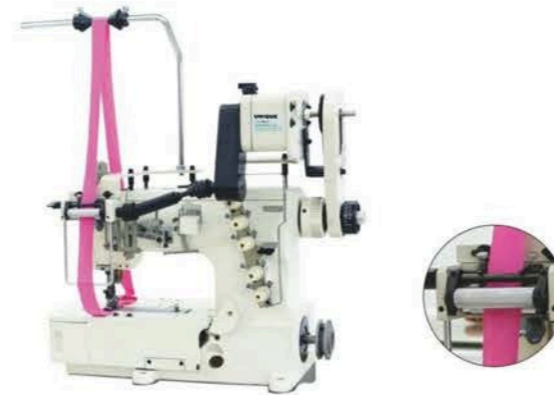

同步送带装置(专用型高速绷缝车送带器)  
Synchronous tape feeder(For Special High-Speed Stretch Sewing Machine)

UN-TFU16-3-3T



同步送带装置(送带装置通用性)  
Synchronous tape feeder(Generality of tape feeders)

UN-TFU16-3



同步送带装置(送带装置通用性)  
Synchronous tape feeder(Generality of tape feeders)

# TOPDIS

## PULLER ATTACHMENT 拖轮组系列

UN-SCK6601



扩张器  
Expander

UN-SDB6630



扩张器  
Expander

UN-SDB6620



扩张器  
Expander

UN-SCK6618



扩张器  
Expander

UN-SCK6612



扩张器  
Expander

UN-SCK6610



扩张器  
Expander

UN-SCK6608



扩张器  
Expander

UN-SCK6602



扩张器  
Expander

UN-SCK6600



扩张器  
Expander

UN-S6230



扩张器  
Expander

UN-S6240



扩张器  
Expander

UN-S6218



扩张器  
Expander

UN-S6212



扩张器  
Expander

UN-S6200



扩张器  
Expander

UN-CK



窗帘数控韩褶机  
Curtain CNC Pleating Machine

UN-XS



自动同步输送机  
Automatic synchronous conveyor

UN-MT

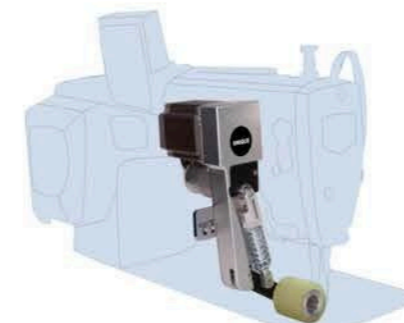

全驱式智能电子拖布轮  
All-drive intelligent puller

UN-CH



窗帘智能裁高机  
Curtain CNC Cutting Machine



主动型送料架  
Active feeding rack

### UN-4D

微电脑分段送带机  
Microcomputer segmented tape feeder



### UN-1E

侧送机  
Side delivery



### UN-6D

微电脑分段送带机  
Microcomputer segmented tape feeder



主动型送料架  
Active feeding rack

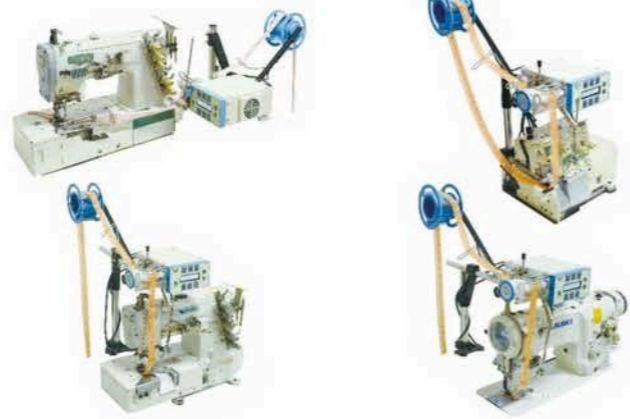

### UN-1E

上送机  
Upper delivery



超声波点位机  
Ultrasonic Pointing Machine



多功能零件柜  
Multifunction alparts cabinet



蓝色  
(颜色尺寸都可定制)

尺寸: 高1956×宽954×深400  
配置: 34个抽屉\*层板\*一块

适用于内衣、内裤、泳装、运动服、家居服装等等，各种高弹性织物的尺寸车缝控制。  
It is suitable for the sewing control of the size of various high elastic fabrics, such as underwear, underwear, swimwear, sportswear, home clothing, etc.





KANSAI SPECIAL 森本33N前轮组 Front puller



SIRUAB 银箭33N前轮组 Front puller



VC008 4N胶齿拖碌28T Rubber teeth



3/16x27N黄平拖碌 (绿架) Flat



VC008 4N铁齿拖碌60T Iron teeth



VC008 12N铁齿拖碌60T Iron teeth



VC008橡胶拖碌黄平12N Rubber



VC008橡胶拖碌黑平12N Rubber flat



PEGASUS 飞马W600橡胶黄平拖碌 Rubber flat



VC008 12N胶齿拖碌28T Rubber flat



1508新款拖碌60T New type



4404橡胶黄平拖碌 Rubber flat



1412橡胶黄平拖碌 Rubber flat



4404胶齿拖碌28T Rubber teeth



PEGASUS 飞马W600胶齿拖碌28T Rubber teeth



4412橡胶黄平拖碌 Rubber flat



1508新款黄平拖碌 New type



1404胶齿拖碌22T Rubber teeth



1404橡胶黄平拖碌 Rubber flat



1412铁齿拖碌60T Iron teeth



1412橡胶黄平拖碌 Rubber flat



4412铁齿拖碌 Iron teeth



1412胶齿拖碌28T Rubber teeth



SHING RAY 星锐R7橡胶 Rubber



4412胶齿拖碌28T Rubber teeth



1508旧款铁齿拖碌60T Iron teeth



00-0610 (1508PR上轮 Upper puller)



1702铁齿拖碌60T Iron teeth



SHING RAY 星锐黄平拖碌 Flat type



1702胶齿拖碌 (蓝齿) Rubber teeth

# TOPDIS

## PULLER ATTACHMENT 拖轮组系列 DISTHING DEVICE 打缆架系列



1508锥度拖碌 Taper type



切耳仔上下碌 Up & down puller for looper cutting machine



VC008前轮组 Front puller ( 12N )



1404胶齿拖碌28T Rubber teeth



00-1400 ( MD前轮 Front )



00-2050-0 ( 滚花 Knurl type )



00-2050-0 ( 直纹 Straight )



00-2050-0 ( 黄平 Flat )

## DISTHING DEVICE 打缆架系列

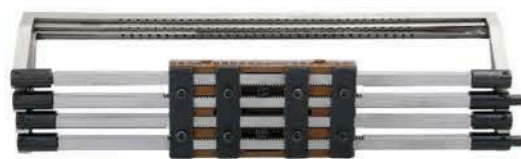

摆线架 Disthing 3/16x33N

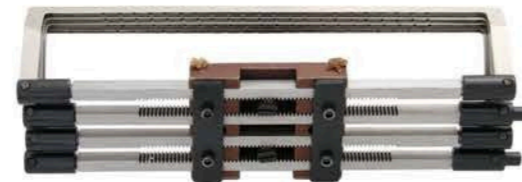

摆线架 Disthing 3/16x25N

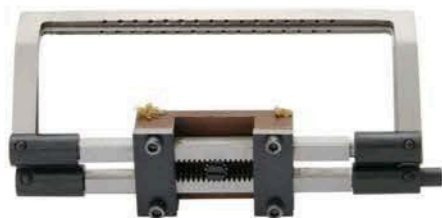

摆线架 Disthing 3/16-16N ( 二线 2 thread )



摆线架 Disthing 3/16-17N

# TOPDIS

## PRESSING BRACKET 啤吟架系列 BUTTON CLAMP 平扣头系列

### PRESSING BRACKET 啤吟架系列



K601



K602



K901A



K901B



K902



K903

### BUTTON CLAMP 平扣头系列



重机JUKI 1903 平扣头  
SNAP BUTTON CLAMP ASSEMBLY



重机JUKI 373 平扣头 ( 加大 )  
SNAP BUTTON CLAMP ASSEMBLY (Big size)



重机JUKI 783 平扣头 ( 加大 )  
SNAP BUTTON CLAMP ASSEMBLY (Big size)



重机JUKI 373 平扣头 ( 加大 )  
SNAP BUTTON CLAMP ASSEMBLY (Big size)

# TOPDIS

## BUTTON CLAMP 订扣组系列



兄弟BROTHER 917立扣组 Shank button clamp



重机JUKI 373立扣组(白架) Shank button clamp



兄弟BROTHER 916平扣组 Shank button clamp



重机JUKI 373平扣组(白架) Shank button clamp



重机JUKI 373平扣组(加大) Shank button clamp



兄弟BROTHER 438D立扣组 Shank button clamp



重机JUKI 783平扣组(加大) Shank button clamp



兄弟BROTHER 438D平扣组 Shank button clamp



重机JUKI 1903立扣组 Shank button clamp



重机JUKI 1903平扣组 Shank button clamp

# TOPDIS

## TUCKING ATTACHMENT 打折器系列



作用：八针一褶  
四针一褶  
Purpose:  
Each 8 stitch  
Each 4 stitch

A900 (G900)

A900 (G900) 附件 Accessory



作用：一针一褶  
Purpose:  
Each 1 stitch

A9 (G9)



银箭 SIRUBA 747



飞马 PEGASUS M700



飞马 PEGASUS L32

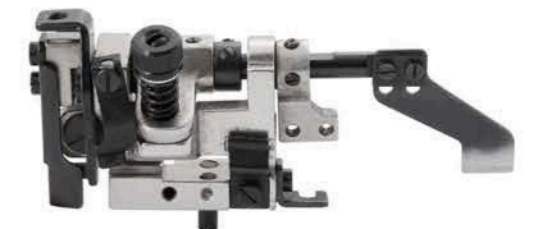



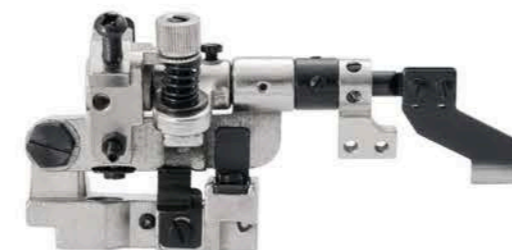









重机 JUKI 2514



兄弟 BROTHER



附件 Accessory

GAUGE SIZE						
						
尺寸	NEEDLE CLAMP 针头	NEEDLE PLATE 针板	FEED DOG 牙齿	PRESSER FOOT 压脚	RETAINER HOLDER 针傍	LOOPER HOLDER 弯针座
1/4*5/8*1/4"	12-4270-1	14-4290-0	15-4290-0	17-4290-1	18-4290-0	19-4380-0
1/4*3/4*1/4"	12-4301-1	14-4270-0	15-4270-0	17-4270-1	18-4270-0	19-4270-0
1/4*7/8*1/4"	12-4310-1	14-4301-0	15-4301-0	17-4301-1	18-4301-0	19-4301-0
1/4*1**1/4"	12-4330-1	14-4310-0	15-4310-0	17-4310-1	18-4310-0	19-4310-0
1/4*1-1/8*1/4"	12-4340-1	14-4330-0	15-4330-0	17-4330-0	18-4330-0	19-4330-0
1/4*1-1/4*1/4"	12-4340-1	14-4340-0	15-4340-0	17-4340-1	18-4340-0	19-4340-0
1/4*1-3/8*1/4"	12-4340-1	14-4340-0	15-4340-0	17-4340-1	18-4340-0	19-4340-0
1/4*1-5/8*1/4"	12-4390-1	14-4390-0	15-4390-0	17-4390-1	18-4390-0	19-4390-0
1/4*1-3/4*1/4"	12-4400-1	14-4400-0	15-4400-0	14-4400-1	18-4400-0	19-4400-0
1/4*1-1/2*1/4"	12-4410-1	14-4410-0	15-4410-0	14-4410-1	18-4410-0	19-4410-0
3/16*5/8*3/16"	12-4370-1	14-4370-0	15-4370-0	17-4370-1	18-4370-0	19-4370-0
3/16*3/4*3/16"	12-4260-1	14-4260-0	15-4260-0	17-4260-1	18-4260-0	19-4260-0
3/16*7/8*3/16"	12-4300-1	14-4320-0	15-4360-0	17-4360-1	18-4360-0	19-4360-0
3/16*1*3/16"	12-4280-1	14-4360-0	15-4320-0	17-4320-1	18-4320-0	19-4300-0
3/16*1/2*3/16"	针板	针板	牙齿	压脚	拉线杆	勾座
5/16*13/16*5/16"	针板	针板	牙齿	压脚	拉线杆	勾座

KANSAI 1404P ( PL ) GAUGE SET

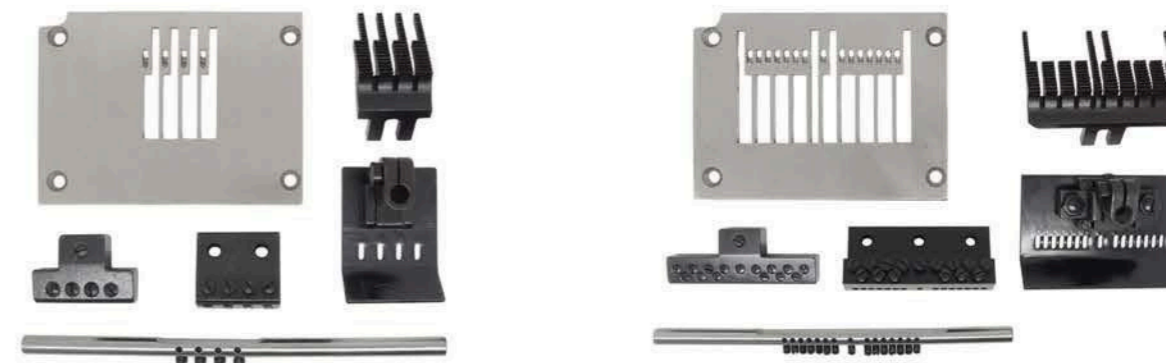

1404P/1404PL GAUGE SET/SIZE

1/4*1N	1"(6N)=1"
1/4*2N	1/8**8N=7/8"
1/2*3N	3/16**8N=1-5/16"
1*(4N)	1/4**8N=1-3/4"
1-1/8(4N)	5/16**8N=2-3/16"
1-1/4(4N)	3/8**8N=2-7/8"
1-3/8(4N)	1/4**9N=2"
3/16**4N=9/16"	1/8**10N=7/8"
1/4**4N=3/4"	3/16**10N=1-11/16"
5/16**4N=15/16"	1/4**10N=2-1/4"
3/8**4N=1-1/8"	1/8**11N ( 不等距 Unequal distance ) =1-1/2"
7/16**4N=1-5/16"	1/8**11N ( 相等距 Equal distance ) =1-1/4"
9/16**4N=1-11/16"	1/8**12N=1-3/8"
1/2**4N=1-1/2"	3/16**12N=2-1/16"
5/8**4N=1-7/8"	1/4**12N=2-3/4"
3/4**4N=1-1/4"	1/8**13N
1**4N=3"	3/16**13N
1-1/4**4N=3-3/4"	1/4**13N
1-7/8**4N=5-5/8"	1/8**15N
1/2**5N=2"	1/8**17N ( 不等距 Unequal distance )
3/16**6N=15/16"	1/8**17N ( 相等距 Equal distance )
1/4**6N=1-1/4"	1/8**17N ( 牙齿有孔 Feed dog have hole )
5/16**6N=1-9/16"	1/8**19
3/8**6N=1-7/8"	1/8**21
7/16**6N=2-3/16"	1/8**21 ( 牙齿有孔 Feed dog have hole )

### KANSAI 1412P/1412PL GAUGE SET



KANSAI 1412P/1412PL GAUGE SET/SIZE	
1"(4N)	3/8"*8N=2-7/8"
1-1/8(4N)	1/4"*9N=2"
1-1/4(4N)	1/8"*10N=7/8"
1-3/8(4N)	3/16"*10N=1-11/16"
3/16"*4N=9/16"	1/4"*10N=2-1/4"
1/4"*4N=3/4"	1/8"*11N (不等距 Unequal distance) =1-1/2"
5/16"*4N=15/16"	1/8"*11N (相等距 Equal distance) =1-1/4"
3/8"*4N=1-1/8"	1/8"*12N=1-3/8"
7/16"*4N=1-5/16"	3/16"*12N=2-1/16"
9/16"*4N=1-11/16"	1/4"*12N=2-3/4"
1/2"*4N=1-1/2"	1/8"*13N
5/8"*4N=1-7/8"	1/8"*13N(乱缝 Random sewing)
3/4"*4N=1-1/4"	3/16"*13N
1"*4N=3"	1/4"*13N
1-1/4"*4N=3-3/4"	1/8"*15N
1-7/8"*4N=5-5/8"	3/16"*16N
1/8"*6N=5/8"	1/8"*17N (不等距 Unequal distance)
3/16"*6N=15/16"	1/8"*17N (相等距 Equal distance)
1/4"*6N=1-1/4"	1/8"*17N (牙齿有孔 Feed dog have hole)
5/16"*6N=1-9/16"	3/16"*17N
3/8"*6N=1-7/8"	1/8"*21N
1"(6N)=1"	1/8"*21N (牙齿有孔 Feed dog have hole)
1/8"*8N=7/8"	1/8"*23N
3/16"*8N=1-5/16"	1/8"*23N (牙齿有孔 Feed dog have hole)
1/4"*8N=1-3/4"	1/8"*25N
5/16"*8N=2-3/16"	1/8"*25N (牙齿有孔 Feed dog have hole)

### KANSAI 1412PQ GAUGE SET









1412PQ针位/Needle 3/16\*12N

1412PQ针位/Needle 3/16\*16N

KANSAI 1412PQ GAUGE SET	
1"(4N)	3/8"*8N=2-7/8"
1-1/8(4N)	1/4"*9N=2"
1-1/4(4N)	1/8"*10N=7/8"
1-3/8(4N)	3/16"*10N=1-11/16"
3/16"*4N=9/16"	1/4"*10N=2-1/4"
1/4"*4N=3/4"	1/8"*11N (不等距 Unequal distance) =1-1/2"
5/16"*4N=15/16"	1/8"*11N (相等距 Equal distance) =1-1/4"
3/8"*4N=1-1/8"	1/8"*12N=1-3/8"
7/16"*4N=1-5/16"	3/16"*12N=2-1/16"
9/16"*4N=1-11/16"	1/4"*12N=2-3/4"
1/2"*4N=1-1/2"	1/8"*13N
5/8"*4N=1-7/8"	1/8"*13N(乱缝 Random sewing)
3/4"*4N=1-1/4"	3/16"*13N
1"*4N=3"	1/4"*13N
1-1/4"*4N=3-3/4"	1/8"*15N
1-7/8"*4N=5-5/8"	3/16"*16N
1/8"*6N=5/8"	1/8"*17N (不等距 Unequal distance)
3/16"*6N=15/16"	1/8"*17N (相等距 Equal distance)
1/4"*6N=1-1/4"	1/8"*17N (牙齿有孔 Feed dog have hole)
5/16"*6N=1-9/16"	3/16"*17N
3/8"*6N=1-7/8"	1/8"*21N
1"(6N)=1"	1/8"*21N (牙齿有孔 Feed dog have hole)
1/8"*8N=7/8"	1/8"*23N
3/16"*8N=1-5/16"	1/8"*23N (牙齿有孔 Feed dog have hole)
1/4"*8N=1-3/4"	1/8"*25N
5/16"*8N=2-3/16"	1/8"*25N (牙齿有孔 Feed dog have hole)

### KANSAI 1501-1508 GAUGE SET

MODEL	SIZE							
机种	尺寸	NEEDLE CLAMP 针头	NEEDLE PLATE 针板	FEED DOG 牙齿	PRESSER FOOT 压脚	NEEDLE GUARD 针傍	LOOPER HOLDER 弯针座	CONNECTING LINK 连杆
1501PHD			14-5020-0	15-5020-0	17-5020-1	18-5010-0	10-9150-1	*
1502P,PMD	3/16"	12-5110-1	14-5110-0	15-5110-0	17-5110-1	18-5200-0	10-9140-0	*
1502P,PMD	1/4"	12-5120-1	14-5120-0	15-5120-0	17-5120-1	18-5210-0	10-9140-1	*
1502P,PMD	5/16"	12-5130-1	14-5130-0	15-5130-0	17-5130-1	18-5210-0	10-9140-1	*
1502PHD	1/4"	12-5220-1	14-5220-0	15-5220-0	17-5220-1	18-5220-0	10-9180-1	*
1503PHD	1/4"	12-5530-1	14-5530-0	15-5530-0	17-5320-1	18-5310-0	10-9160-1	*
1503PTF	1/4"	12-5530-1	14-5530-0	15-5530-0	17-5530-1	18-5310-0	10-9160-1	*
1503PTF	9/32	12-5540-1	14-5540-0	15-5530-0	17-5540-1	18-5310-0	10-9160-1	*
1504P,PMD	1"	12-5410-1	14-5410-0	15-5410-0	17-5410-1	18-5410-0	10-9120-1	*
1504P,PMD	1-1/8"	12-5420-1	14-5420-0	15-5420-0	17-5420-1	18-5420-0	10-9120-1	*
1507P	7/8"	12-5700-1	14-5700-0	15-5700-0	17-5700-1	18-5700-0	10-9730-1	66-5160-0
1507P	1"	12-5710-1	14-5710-0	15-5710-0	17-5710-1	18-5700-0	10-9730-2	66-5170-0
1507P	1-1/8"	12-5720-1	14-5720-0	15-5720-0	17-5720-1	18-5720-0	10-9730-3	66-5180-0
1507P	1-1/4"	12-5730-1	14-5730-0	15-5730-0	17-5730-1	18-5720-0	10-9730-4	66-5190-0
1507P	1-1/2"	12-5740-1	14-5740-0	15-5740-0	17-5740-1	18-5740-0	10-9730-5	66-5200-0
1508P,PR	1/4*5/8*1/4=1-1/8"	12-5780-1	14-5780-0	15-5780-0	17-5780-1	18-5780-0	*	66-5180-0
1508P,PR	1/4*3/4*1/4=1-1/4"	12-5830-1	14-5830-0	15-5830-0	17-5830-1	18-5830-0	10-9730-2 10-9240-3 NEW	66-5190-0
1508P,PR	1/4*7/8*1/4=1-3/8"	12-5800-1	14-5800-0	15-5800-0	17-5800-1	18-5800-0	*	66-5200-1
1508P,PR	1/4*1*1/4=1-1/2"	12-5810-1	14-5810-0	15-5810-0	17-5810-1	18-5810-0	10-9840-1	66-5200-0
1508P,PR	1/4*1-1/8*1/4=1-5/8"	12-5790-1	14-5790-0	15-5790-0	17-5790-1	18-5790-0	*	66-5220-0
1508P,PR	1/4*1-1/4*1/4=1-3/4"	12-5840-1	14-5840-0	15-5840-0	17-5840-1	18-5840-0	*	66-5230-0
1508P,PR	1/4*1-3/8*1/4=1-7/8"	12-5850-1	14-5850-0	15-5850-0	17-5850-1	18-5850-0	*	66-5240-0
1508P,PR	1/4*1-1/2*1/4=2"	12-5860-1	14-5860-0	15-5860-0	17-5860-1	18-5860-0	*	66-5250-0
1508P,PR	3/16*1*3/16=1-3/8"	12-5820-1	14-5820-0	15-5820-0	17-5820-1	18-5820-0	10-9840-2 10-9240-2 NEW	66-5210-0
1508PD	1/4*1*1/4	12-5810-1	14-5810-0	98-1240-0 98-1190-0	17-5810-1	98-1200-0	10-9840-1 10-9240-1 NEW	66-5200-0

### KANSAI 4404P ( PL ) GAUGE SET



### 4404P GAUGE SET/SIZE

1/4*1N	1"(6N)=1"
1/4*2N	1/8"*8N=7/8"
1/2*3N	3/16"*8N=1-5/16"
1"(4N)	1/4"*8N=1-3/4"
1-1/8(4N)	5/16"*8N=2-3/16"
1-1/4(4N)	3/8"*8N=2-7/8"
1-3/8(4N)	1/4"*9N=2"
3/16"*4N=9/16"	1/8"*10N=7/8"
1/4"*4N=3/4"	3/16"*10N=1-11/16"
5/16"*4N=15/16"	1/4"*10N=2-1/4"
3/8"*4N=1-1/8"	1/8"*11N ( 不等距 Unequal distance ) =1-1/2"
7/16"*4N=1-5/16"	1/8"*11N ( 相等距 Equal distance ) =1-1/4"
9/16"*4N=1-11/16"	1/8"*12N=1-3/8"
1/2"*4N=1-1/2"	3/16"*12N=2-1/16"
5/8"*4N=1-7/8"	1/4"*12N=2-3/4"
3/4"*4N=1-1/4"	1/8"*13N
1"*4N=3"	3/16"*13N
1-1/4"*4N=3-3/4"	1/4"*13N
1-7/8"*4N=5-5/8"	1/8"*15N
1/2"*5N=2"	1/8"*17N ( 不等距 Unequal distance )
3/16"*6N=15/16"	1/8"*17N ( 相等距 Equal distance )
1/4"*6N=1-1/4"	1/8"*17N ( 牙齿有孔 Feed dog have hole )
5/16"*6N=1-9/16"	1/8"*19
3/8"*6N=1-7/8"	1/8"*21
7/16"*6N=2-3/16"	1/8"*21 ( 牙齿有孔 Feed dog have hole )







KANSAI 4412P ( PL ) GAUGE SET



4412P GAUGE SET/SIZE

1"(4N)	3/8"*8N=2-7/8"
1-1/8(4N)	1/4"*9N=2"
1-1/4(4N)	1/8"*10N=7/8"
1-3/8(4N)	3/16"*10N=1-11/16"
3/16"*4N=9/16"	1/4"*10N=2-1/4"
1/4"*4N=3/4"	1/8"*11N ( 不等距 Unequal distance ) =1-1/2"
5/16"*4N=15/16"	1/8"*11N ( 相等距 Equal distance ) =1-1/4"
3/8"*4N=1-1/8"	1/8"*12N=1-3/8"
7/16"*4N=1-5/16"	3/16"*12N=2-1/16"
9/16"*4N=1-11/16"	1/4"*12N=2-3/4"
1/2"*4N=1-1/2"	1/8"*13N
5/8"*4N=1-7/8"	1/8"*13N(乱缝 Random sewing )
3/4"*4N=1-1/4"	3/16"*13N
1"*4N=3"	1/4"*13N
1-1/4"*4N=3-3/4"	1/8"*15N
1-7/8"*4N=5-5/8"	3/16"*16N
1/8"*6N=5/8"	1/8"*17N ( 不等距 Unequal distance )
3/16"*6N=15/16"	1/8"*17N ( 相等距 Equal distance )
1/4"*6N=1-1/4"	1/8"*17N ( 牙齿有孔 Feed dog have hole )
5/16"*6N=1-9/16"	3/16"*17N
3/8"*6N=1-7/8"	1/8"*21N
1"(6N)=1"	1/8"*21N ( 牙齿有孔 Feed dog have hole )
1/8"*8N=7/8"	1/8"*23N
3/16"*8N=1-5/16"	1/8"*23N ( 牙齿有孔 Feed dog have hole )
1/4"*8N=1-3/4"	1/8"*25N
5/16"*8N=2-3/16"	1/8"*25N ( 牙齿有孔 Feed dog have hole )

KANSAI 1702P GAUGE SET

MODEL	SIZE						
机种	尺寸	NEEDLE BAR	NEEDLE CLAMP	NEEDLE PLATE	FEED DOG	PRESSER FOOT	NEEDLE GUARD
		针棒	针头	针板	牙齿	压脚	针傍
1702B	3/16	11-704	12-2170-1	14-743	15-704	17-7420-1	18-702
	7/32		12-2280-1	14-753		17-7520-1	
1702BK	1/4		12-2290-1	14-763		17-7620-1	
	3/16		12-2180-1	14-743		17-7420-1	
	7/32		12-2190-1	14-753		17-7520-1	
	1/4		12-2200-1	14-763	17-7620-1		
1702P,PMD	1/8		12-2150-1	14-724	15-703	17-6760-1	18-702
	5/32		12-2160-1	14-734		17-6770-1	
	3/16		12-2170-1	14-744	15-704	17-6780-1	
	7/32		12-2280-1	14-754		17-6790-2	
	1/4		12-2290-1	14-764		17-6800-1	
1702MLH	1/8	12-2150-1	14-721	15-321	17-7210-1		
1701EHD		11-713	14-718	15-718	17-7180-1		
1702EHD	1/4	11-720	12-7180-1	14-717	15-710	17-7190-1	18-731
DVK1702BK	1/4 ( 264 )	11-726	12-7020-1	14-760	15-760	17-7600-1	
DVK1702B	1/4 ( 264 )			14-764	15-704	17-762	
B2000 ( 264 )		11-704	12-2290-1	14-763	15-704	17-7602-1	
B2000 ( 264 )				14-760	15-7600-0	17-7600-1	

### SIRUBA VC008 GAUGE SET



### VC008P GAUGE SET/SIZE

尺寸	规格
1/4*1/2*1/4"	1/4"*6N=1-1/4"
1/4*5/8*1/4"	5/16"*6N=1-9/16"
1/4*3/4*1/4"	3/8"*6N=1-7/8"
1/4*7/8*1/4"	1"(6N)=1"
1/4*1"*1/4"	1/8"*8N=7/8"
1/4*1-1/8*1/4"	3/16"*8N=1-5/16"
1/4*1-1/4*1/4"	1/4"*8N=1-3/4"
1/4*1-3/8*1/4"	5/16"*8N=2-3/16"
1/4*1-5/8*1/4"	3/8"*8N=2-7/8"
1/4*1-3/4*1/4"	1/4"*9N=2"
1/4*1-1/2*1/4"	1/8"*10N=7/8"
3/16*5/8*3/16"	3/16"*10N=1-11/16"
3/16*3/4*3/16"	1/4"*10N=2-1/4"
3/16*7/8*3/16"	1/8"*11N (不等距 Unequal distance) =1-1/2"
3/16*1*3/16"	1/8"*11N (相等距 Equal distance) =1-1/4"
3/16*1/2*3/16"	1/8"*12N=1-3/8"
1"(4N)	3/16"*12N=2-1/16"
1-1/8(4N)	1/4"*12N=2-3/4"
1-1/4(4N)	1/8"*13N
1-3/8(4N)	1/8"*13N (乱缝 Random sewing)
3/16*4N=9/16"	3/16"*13N
1/4*4N=3/4"	1/4"*13N
5/16*4N=15/16"	1/8"*15N
3/8*4N=1-1/8"	3/16"*16N
7/16*4N=1-5/16"	1/8"*17N (不等距 Unequal distance)
9/16*4N=1-11/16"	1/8"*17N (相等距 Equal distance)
1/2*4N=1-1/2"	1/8"*17N (牙齿有孔 Feed dog have hole)
5/8*4N=1-7/8"	3/16"*17N
3/4*4N=1-1/4"	1/8"*21N
1"*4N=3"	1/8"*21N (牙齿有孔 Feed dog have hole)
1-1/4*4N=3-3/4"	1/8"*23N
1-7/8*4N=5-5/8"	1/8"*23N (牙齿有孔 Feed dog have hole)
1/8*6N=5/8"	1/8"*25N
3/16*6N=15/16"	1/8"*25N (牙齿有孔 Feed dog have hole)

### 兄弟双针机针位组 (BROTHER)

MODEL	SIZE	NEEDLE PLATE	FEED DOG	NEEDLE CLAMP	PRESSER FOOT	PRESSER FOOT
机种	尺寸	针板	牙齿	针头	压脚	压脚
LT2-841 LT2-842 LT2-872	1/16	142111-0-01	151078-0-01	158808-0-01	151076-0-01	*
	1/8	114950-0-01	114951-0-01	158794-0-01	114948-0-01	*
		117369-0-01	114951-0-01	158794-0-01	114948-0-01	155463-0-01
	5/32	117369-0-01	158430-0-01	158794-0-01	114948-0-01	155463-0-01
		116503-0-01	116509-0-01	158796-0-01	116502-0-01	*
	3/16	150850-0-01	116509-0-01	158796-0-01	116502-0-01	155455-0-01
		112603-0-01	112659-0-01	158791-0-01	112638-0-01	*
		117133-0-01	112659-0-01	158791-0-01	112638-0-01	155457-0-01
	7/32	117133-0-01	S13588-0-01	158791-0-01	112638-0-01	155457-0-01
		117133-0-01A	112659-0-01A	158791-0-01A	112638-0-01A	S16224-0-01
	1/4	112604-0-01	112660-0-01	158792-0-01	112642-0-01	*
		117367-0-01	112660-0-01	158792-0-01	112642-0-01	155453-0-01
		117367-0-01	153882-0-01	158792-0-01	112642-0-01	155453-0-01
	5/16	112605-0-01	112661-0-01	158793-0-01	112645-0-01	*
		144882-0-01	112661-0-01	158793-0-01	112645-0-01	155459-0-01
		116506-1-01	116510-1-01	158798-0-01	116498-0-01	*
	3/8	144881-1-01	116510-1-01	158798-0-01	116498-0-01	155461-0-01
		144881-1-01	153887-0-01	158798-0-01	116498-0-01	155461-0-01
	7/16	151596-0-01	151598-0-01	158809-0-01	151597-0-01	*
	1/2	116505-0-01	116511-0-01	158797-0-01	116499-0-01	*
		S09365-0-01	116511-0-01	158797-0-01	116499-0-01	S09367-0-01
		S09365-0-01	153892-0-01	158797-0-01	116499-0-01	S09367-0-01
	5/8	116507-0-01	116512-0-01	158795-0-01	116500-0-01	*
		159577-0-01	116512-0-01	158795-0-01	116500-0-01	159575-0-01
		159577-0-01	153897-0-01	158795-0-01	116500-0-01	159575-0-01
	3/4	159577-0-01A	116512-0-01A	158806-0-01	116500-0-01A	159575-0-01A
	7/8	159577-0-01B	116512-0-01B	158807-0-01	116500-0-01B	159575-0-01B
	1"	147176-0-01	147178-0-01	158805-0-01	147177-0-01	159575-0-01C
	1-1/4	116504-0-01	116508-0-01	158799-0-01	116501-0-01	*
	1-3/8	S14148-0-01	S14149-0-01	S10746-0-01	S14151-0-01	*
1-1/2	118945-0-01	118947-0-01	158800-0-01	118946-0-01	S10751-0-01	
2"	144951-0-01	144947-0-01	158802-0-01	144949-0-01	1449530-0-01	

### 兄弟双针机针位组 (BROTHER)

### 兄弟双针机针位组 (BROTHER)

MODEL	SIZE						
机种	尺寸	NEEDLE PLATE	FEED DOG	NEEDLE CLAMP	LT2-B842	LT2-B872	
		针板	牙齿	针头	压脚	压脚	
LT2-B841	1/8	155722-0-01	148699-0-01	158794-0-01	148681-0-01	155463-0-01	
	5/32	155724-0-01	148701-0-01	158796-0-01	148683-0-01	155455-0-01	
	3/16	155851-0-01	148703-0-01	158791-0-01	148691-0-01	155457-0-01	
			S07905-0-01				
	7/32	156816-0-01	156818-0-01	158791-0-01A	156819-0-01	S16224-0-01	
	1/4	155853-0-01	148705-0-01	158792-0-01	158695-0-01	155453-0-01	
			158756-0-01				
	5/16	155855-0-01	149691-0-01	158793-0-01	149687-0-01	155459-0-01	
	LT2-B842	3/8	155857-0-01	149938-0-01	158798-0-01	149940-0-01	155461-0-01
	LT2-B872	1/2	149677-0-01	149675-0-01	158797-0-01	149671-0-01	S09367-0-01
		5/8	149954-0-01	149948-0-01	158795-0-01	149950-0-01	159575-0-01
		3/4	150526-0-01	150523-0-01	158806-0-01	150524-0-01	150524-0-01
7/8		150534-0-01	150531-0-01	158807-0-01	150532-0-01	150532-0-01	
1"		149966-0-01	149960-0-01	158805-0-01	149962-0-01	S13626-0-01	
1-1/8		S16104-0-01	S16106-0-01	S16102-0-01	S16107-0-01	S16107-0-01	
1-1/4		S10741-0-01	S10743-0-01	158799-0-01	S10744-0-01	S10744-0-01	
1-3/8		S10748-0-01	S10750-0-01	S10746-0-01	S10751-0-01	S10751-0-01	

MODEL	SIZE						
机种	尺寸	NEEDLE PLATE	FEED DOG	NEEDLE CLAMP(L)	NEEDLE CLAMP(R)	LT2-B845	LT2-B875
		针板	牙齿	针头 (左)	针头 (右)	压脚	压脚
LT2-B845 LT2-B875	1/8	117369-0-01	114951-0-01 158430-0-01	S15711-0-01	S15712-0-01	114948-0-01	155463-0-01
	5/32	150850-0-01	116509-0-01	S15717-0-01	S15718-0-01	116502-0-01	155455-0-01
	3/16	117133-0-01	112659-0-01	S15723-0-01	S15724-0-01	112638-0-01	155457-0-01
			S13588-0-01				
	7/32	11713-0-01A	112659-0-01A	S5729-0-01	S15730-0-01	112638-0-01A	S16224-0-01
	1/4	117367-0-01	112660-0-01	S15735-0-01	S15736-0-01	112642-0-01	155453-0-01
			153882-0-01				
	5/16	144882-0-01	112661-0-01	S1574-0-01	S15748-0-01	112645-0-01	155459-0-01
	3/8	144881-1-01	116510-1-01	S15753-0-01	S15754-0-01	116498-0-01	155461-0-01
			116511-0-01				
	1/2	S09365-0-01	116512-0-01	S15765-0-01	S15766-0-01	116499-0-01	S09367-0-01
			153897-0-01				
	5/8	159577-0-01	116512-0-01	S15771-0-01	S15772-0-01	116500-0-01	159575-0-01
			153897-0-01				
	3/4	159577-0-01A	116512-0-01A	S3212-0-01	S32123-0-01	116500-0-01A	150524-0-01
	7/8	159577-0-01B	116512-0-01B	S15783-0-01	S15784-0-01	116500-0-01B	150532-0-01
1"	147176-0-01	147178-0-01	S15795-0-01	S15796-0-01	147177-0-01	S13626-0-01	
LT2-B845	1/8	155722-0-01	148699-0-01	S15711-0-01	S15712-0-01	148681-0-01	155463-0-01
	5/32	155724-0-01	148701-0-01	S15717-0-01	S15718-0-01	148683-0-01	155455-0-01
	3/16	155851-0-01	148703-0-01	S15723-0-01	S15724-0-01	148691-0-01	155457-0-01
			S07905-0-01				
	7/32	156816-0-01	156818-0-01	S15729-0-01	S15730-0-01	156819-0-01	S16224-0-01
	1/4	155853-0-01	148705-0-01	S15735-0-01	S15736-0-01	148695-0-01	155453-0-01
			158756-0-01				
	5/16	155855-0-01	149691-0-01	S15747-0-01	S15748-0-01	149687-0-01	155459-0-01
	3/8	155857-0-01	149938-0-01	S15753-0-01	S15754-0-01	149940-0-01	155461-0-01
	1/2	149677-0-01	149675-0-01	S15765-0-01	S15766-0-01	149671-0-01	S09367-0-01
	5/8	149954-0-01	149948-0-01	S15771-0-01	S15772-0-01	149950-0-01	159575-0-01
	3/4	150526-0-01	150523-0-01	S32122-0-01	S32123-0-01	150524-0-01	150524-0-01
	7/8	150534-0-01	150531-0-01	S15783-0-01	S15784-0-01	150532-0-01	150532-0-01
	1"	149966-0-01	149960-0-01	S15795-0-01	S15796-0-01	149962-0-01	S13626-0-01

兄弟双针机针位组 (BROTHER)

MODEL	SIZE				
机种	尺寸	NEEDLE PLATE 针板	FEED DOG 牙齿	NEEDLE CLAMP 针头	PRESSER FOOT 压脚
LT2-B831 LT2-B832	1/8	117370-0-01	117366-0-01	114947-0-01	149311-0-01
		114950-0-01	114951-0-01		114948-0-01
		117369-0-01			
	5/32	116053-0-01	116509-0-01	116489-0-01	116502-0-01
	3/16	117158-0-01	117134-0-01	112599-0-01	117281-0-01
		112603-0-01	112659-0-01		112638-0-01
		117133-0-01			
	1/4	117368-0-01	117365-0-01	112600-0-01	149312-0-01
		112604-0-01	112660-0-01		112642-0-01
		117367-0-01			
	5/16	112605-0-01	112661-0-01	112601-0-01	112645-0-01
		144882-0-01			
	3/8	116506-1-01	116510-0-01	116491-0-01	116498-0-01
		144881-1-01			
	1/2	116505-0-01	116511-0-01	116490-0-01	116499-0-01
	5/8	116507-0-01	116512-0-01	116488-0-01	116500-0-01
	1-1/4	116504-0-01	116508-0-01	116492-0-01	116501-0-01
1-1/2	118945-0-01	118947-0-01	118944-0-01	118946-0-01	
2"	144951-0-01	144947-0-01	144948-0-01	144949-0-01	

MODEL	SIZE				
机种	尺寸	NEEDLE PLATE 针板	FEED DOG 牙齿	NEEDLE CLAMP 针头	PRESSER FOOT 压脚
LT2-B835	1/8	117369-0-01	114951-0-01	150885-0-01	114948-0-01
	5/32	150850-0-01	116509-0-01	150843-0-01	116502-0-01
	3/16	117133-0-01	112659-0-01	150844-0-01	112638-0-01
	1/4	117367-0-01	112660-0-01	150830-0-01	112642-0-01
	5/16	144882-0-01	112661-0-01	1508450-0-01	112645-0-01
	3/8	144881-1-01	116510-1-01	150846-0-01	116498-0-01

兄弟双针机针位组 (BROTHER)

MODEL	SIZE				
机种	尺寸	NEEDLE PLATE 针板	FEED DOG 牙齿	NEEDLE CLAMP 针头	PRESSER FOOT 压脚
LT2-B831-400/450 LT2-B832-400/450	3/32	153232-0-01	148697-0-01	148678-0-01	148679-0-01
		148710-0-01	148698-0-01		148685-0-01
	1/8	148712-0-01	148699-0-01	114947-0-01	148681-0-01
		153234-0-01			
		148714-0-01			148700-0-01
	5/32	148716-0-01	148701-0-01	112599-0-01	148683-0-01
		148718-0-01	148702-0-01		149687-0-01
	3/16	148720-0-01	148703-0-01	112599-0-01	148691-0-01
		153236-0-01			
		148722-0-01			148704-0-01
	1/4	148724-0-01	148705-0-01	112600-0-01	148695-0-01
		153238-0-01			
		149695-0-01			149692-0-01
	5/16	149693-0-01	149691-0-01	116491-0-01	149687-0-01
		149946-0-01	149939-0-01		149942-0-01
	3/8	149944-0-01	149938-0-01	116490-0-01	149940-0-01
		149679-0-01	149676-0-01		149673-0-01
	1/2	149677-0-01	149675-0-01	116488-0-01	149671-0-01
		149956-0-01	149949-0-01		149952-0-01
	5/8	149954-0-01	149948-0-01	116488-0-01	149950-0-01
		153240-0-01			
150526-0-01		150523-0-01			150522-0-01
7/8	150534-0-01	150531-0-01	150530-0-01	150532-0-01	
1"	149966-0-01	149960-0-01	149985-0-01	149962-0-01	

MODEL	SIZE				
机种	尺寸	NEEDLE PLATE 针板	FEED DOG 牙齿	NEEDLE CLAMP 针头	PRESSER FOOT 压脚
LT2-B835-400/450	1/8	148712-0-01	148698-0-01	150885-0-01	148685-0-01
			148699-0-01		148681-0-01
	5/32	148716-0-01	148700-0-01	150843-0-01	148689-0-01
			148701-0-01		148683-0-01
	3/16	148720-0-01	148702-0-01	150844-0-01	148687-0-01
			148703-0-01		148691-0-01
	1/4	148720-0-01	148704-0-01	150830-0-01	148693-0-01
			148705-0-01		148695-0-01
	5/16	149693-0-01	149692-0-01	1508450-0-01	149689-0-01
			149691-0-01		149687-0-01
	3/8	149944-0-01	149939-0-01	150846-0-01	149942-0-01
			1499380-01		149940-0-01

### 重机双针机针位组 (JUKI)

MODEL	SIZE					
机种	尺寸	NEEDLE PLATE	FEED DOG	NEEDLE CLAMP	LH-512 LH-515 PRESSER FOOT	LH-512-S LH-515-S PRESSER FOOT
		针板	牙齿	针头	压脚	压脚
LH-512 LH-515 LH512-S LH-515-S	1/32	B1109-512-A01	B1613-512-A01	B1402-051-AA1	B1524-512-AAD1	B1524-512-AA1
	1/16	B1109-512-A02	B1613-512-A02	B1402-051-AA2	B1524-512-AAD2	B1524-512-AA2
	3/32	B1109-512-A00	B1613-512-A00	B1402-051-AA0	B1524-512-AAD	B1524-512-AA0
	1/8	B1109-512-B00A	B1613-512-B00	B1402-051-BA0	B1524-512-BAD	B1524-512-BA0
	5/32	B1109-512-C00	B1613-512-C00	B1402-051-CA0	B1524-512-CAD	B1524-512-CA0
	3/16	B1109-512-D00	B1613-512-D00	B1402-051-DA0	B1524-512-DAD	B1524-512-DA0
	7/32	B1109-512-E00	B1613-512-E00	B1402-051-EA0	B1524-512-EAD	B1524-512-EA0
	1/4	B1109-512-F00	B1613-512-F00	B1402-051-FA0	B1524-512-FAD	B1524-512-FA0
	9/32	B1109-512-G00	B1613-512-G00	B1402-051-GA0	B1524-512-GAD	B1524-512-GA0
	5/16	B1109-512-H00	B1613-512-H00	B1402-051-HA0	B1524-512-HAD	B1524-512-HA0
	11/32	B1109-512-H01	B1613-512-H01	B1402-051-HA1	B1524-512-HAD1	B1524-512-HA1
	3/8	B1109-512-K00	B1613-512-K00	B1402-051-KA0	B1524-512-KAD	B1524-512-KA0
	13/32	B1109-512-K01	B1613-512-K01	B1402-051-KA1	B1524-512-KAD1	B1524-512-KA1
	7/16	B1109-512-W00	B1613-512-W00	B1402-051-WA0	B1524-512-WAD	B1524-512-WA0
	15/32	B1109-512-W01	B1613-512-W01	B1402-051-WA1	B1524-512-WAD1	B1524-512-WA1
	1/2	B1109-512-L00	B1613-512-L00	B1402-051-LA0	B1524-512-LAD	B1524-512-LA0
	17/32	B1109-512-L01	B1613-512-L01	B1402-051-LA1	B1524-512-LAD1	B1524-512-LA1
	9/16	B1109-512-L02	B1613-512-L02	B1402-051-LA2	B1524-512-LAD2	B1524-512-LA2
	19/32	B1109-512-L03	B1613-512-L03	B1402-051-LA3	B1524-512-LAD3	B1524-512-LA3
	5/8	B1109-512-M00	B1613-512-M00	B1402-051-MA0	B1524-512-MAD	B1524-512-MA0
	11/16	B1109-512-M01	B1613-512-M01	B1402-051-MA1	B1524-512-MAD1	B1524-512-MA1
	3/4	B1109-512-N00	B1613-512-N00	B1402-051-NA0	B1524-512-NAD	B1524-512-NA0
	13/16	B1109-512-N01	B1613-512-N01	B1402-051-NA1	B1524-512-NAD1	B1524-512-NA1
	7/8	B1109-512-P00	B1613-512-P00	B1402-051-PA0	B1524-512-PAD	B1524-512-PA0
	15/16	B1109-512-P01	B1613-512-P01	B1402-051-PA1	B1524-512-PAD1	B1524-512-PA1
	1"	B1109-512-Q00	B1613-512-Q00	B1402-051-QA0	B1524-512-QAD	B1524-512-QA0
	1-1/16	B1109-512-Q01	B1613-512-Q01	B1402-051-QA1	B1524-512-QAD1	B1524-512-QA1
	1-1/8	B1109-512-R00	B1613-512-R00	B1402-051-RA0	B1524-512-RAD	B1524-512-RA0
	1-3/16	B1109-512-R01	B1613-512-R01	B1402-051-RA1	B1524-512-RAD1	B1524-512-RA1
	1-1/4	B1109-512-S00	B1613-512-S00	B1402-051-SA0	B1524-512-SAD	B1524-512-SA0
	1-5/16	B1109-512-S01	B1613-512-S01	B1402-051-SA1	B1524-512-SAD1	B1524-512-SA1
	1-3/8	B1109-512-T00	B1613-512-T00	B1402-051-TA0	B1524-512-TAD	B1524-512-TA0
	1-7/16	B1109-512-T01	B1613-512-T01	B1402-051-TA1	B1524-512-TAD1	B1524-512-TA1
	1-1/2	B1109-512-U00	B1613-512-U00	B1402-051-UA0	B1524-512-UAD	B1524-512-UA0
	1-9/16	B1109-512-U01	B1613-512-U01	B1402-051-UA1	B1524-512-UAD1	B1524-512-UA1
	1-5/8	B1109-512-U02	B1613-512-U02	B1402-051-UA2	B1524-512-UAD2	B1524-512-UA2
	1-11/16	B1109-512-U03	B1613-512-U03	B1402-051-UA3	B1524-512-UAD3	B1524-512-UA3
	1-3/4	B1109-512-U04	B1613-512-U04	B1402-051-UA4	B1524-512-UAD4	B1524-512-UA4
	1-7/8	B1109-512-U05	B1613-512-U05	B1402-051-UA5	B1524-512-UAD5	B1524-512-UA5
	1-15/16	B1109-512-U06	B1613-512-U06	B1402-051-UA6	B1524-512-UAD6	B1524-512-UA6
	2"	B1109-512-U07	B1613-512-U07	B1402-051-UA7	B1524-512-UAD7	B1524-512-UA7

### 重机双针机针位组 (JUKI)

MODEL	SIZE					
机种	尺寸	NEEDLE PLATE	FEED DOG	NEEDLE CLAMP NEEDLE HOLDER	LH-1152 PRESSER FOOT	LH-1152-S PRESSER FOOT
		针板	牙齿	针头	压脚	压脚
LH-1152 LH-1152-S	3/32	102-27105	B1613-512-A00	101-47551	101-52452	101-56648
	1/8	102-27106	B1613-512-B00	101-47650	101-52551	101-56649
	5/32	102-27205	B1613-512-C00	101-47759	101-52650	101-56650
	3/16	101-37503	B1613-512-D00	101-47858	101-52759	101-56651
	7/32	102-27304	B1613-512-E00	101-47957	101-52858	101-56652
	1/4	101-37602	B1613-512-F00	101-48054	101-52957	101-56653
	9/32	102-27403	B1613-512-G00	101-48153	101-53054	101-56654
	5/16	101-37701	B1613-512-H00	101-48252	101-53153	101-56655
	3/8	101-37800	B1613-512-K00	101-48351	101-53252	101-56656
	7/16	101-37801	B1613-512-W00	101-48450	101-53351	101-56657
	1/2	101-37909	B1613-512-L00	101-48559	101-53450	101-56658
	9/16	101-37910	B1613-512-L02	101-48560	101-53451	101-56659
	5/8	10-38006	B1613-512-M00	101-48658	101-53559	101-56660
	3/4	101-38105	B1613-512-N00	101-48757	101-53658	101-56661
	7/8	101-38204	B1613-512-P00	101-48856	101-53757	101-56662
	1"	101-38303	B1613-512-Q00	101-48955	101-53856	101-56663
	1-1/8	101-38402	B1613-512-R00	101-49052	101-53955	101-56664
	1-1/4	101-38501	B1613-512-S00	101-49151	101-54052	101-56665
	1-3/8	101-38600	B1613-512-T00	101-49250	101-54151	101-56666
	1-1/2	101-38709	B1613-512-U00	101-49359	101-54250	101-56667

MODEL	SIZE				
机种	尺寸	NEEDLE PLATE	FEED DOG	NEEDLE HOLDER	PRESSER FOOT
		针板	牙齿	针头	压脚
LH-1152-7	1/8	102-21109	102-25704	101-49650	101-56649
	5/32	102-21208	101-67609	101-47759	101-56650
	3/16	101-32504	101-67708	101-47858	101-56651
	7/32	102-21406	101-67807	101-47957	101-56652
	1/4	101-32603	101-67906	101-48054	101-56653
	9/32	102-21604	101-68003	101-48153	101-56654
	5/16	101-32702	101-68102	101-48252	101-56655
	3/8	101-32801	101-68201	101-48351	101-56656
	7/16	102-21803	101-68300	101-48450	101-56657
	1/2	101-32900	101-68409	101-48559	101-56658
	5/8	101-33007	101-68508	101-48658	101-56659
	3/4	101-33106	101-68607	101-48757	101-56660
	7/8	101-33205	101-68706	101-48856	101-56661
	1"	101-33304	101-68805	101-48955	101-56662
	1-1/8	101-33403	101-68904	101-49052	101-56663
	1-1/4	101-33502	101-69001	101-49151	101-56664

### 重机双针机针位组 (JUKI)

MODEL	SIZE						
机种	尺寸	NEEDLE PLATE	NEEDLE PLATE	FEED DOG	NEEDLE HOLDER	NEEDLE HOLDER	PRESSER FOOT
		针板	针板	牙齿	针头	针头	压脚
LH-1162 LH-1182	1/8	102-27106	102-35703	B1613-512-B00	B1402-526-BAL-A	B1402-526-BAR-A	102-22255
	5/32	102-27205	102-35802	B1613-512-C00	B1402-526-CAL-A	B1402-526-CAR-A	102-22354
	3/16	101-37503	102-35901	B1613-512-D00	B1402-526-DAL-A	B1402-526-DAR-A	102-22453
	7/32	102-27304	102-36008	B1613-512-E00	102-28559	102-28567	102-22552
	1/4	101-37602	102-36107	B1613-512-F00	B1402-526-FAL-A	B1402-526-FAR-A	102-22651
	9/32	102-27403	102-36206	B1613-512-G00	B1402-526-GAL-A	B1402-526-GAR-A	102-22750
	5/16	101-37701	102-36305	B1613-512-H00	B1402-526-HAL-A	B1402-526-HAR-A	102-22859
	3/8	101-37800	102-36404	B1613-512-K00	B1402-526-KAL-A	B1402-526-KAR-A	102-22958
	7/16	101-37801	101-37801	B1613-512-W00	B1402-526-IAL-A	B1402-526-IAR-A	102-22959
	1/2	101-37909	102-36503	B1613-512-L00	B1402-526-LAL-A	B1402-526-LAR-A	102-23253
	9/16	101-37910	101-37910	B1613-512-L02	B1402-526-VAL-A	B1402-526-VAR-A	102-23254
	5/8	101-38006	102-33708	B1613-512-M00	102-28856	102-28864	102-23352
	3/4	101-38105	102-33807	B1613-512-N00	102-28955	102-28963	102-23550
	7/8	101-38204	101-38204	B1613-512-P00	102-28956	102-28964	102-23551
1"	101-38303	102-33906	B1613-512-Q00	102-29151	102-29169	102-23758	







MODEL	SIZE					
机种	尺寸	NEEDLE PLATE	FEED DOG	NEEDLE HOLDER ( L )	NEEDLE HOLDER ( R )	PRESSER FOOT
		针板	牙齿	针头	针头	压脚
LH-1162-7 LH-1182-7	1/8	102-21109	102-25704	B1402-526-BAL-A	B1402-526-BAR-A	102-22255
	5/32	102-21208	101-67609	B1402-526-CAL-A	B1402-526-CAR-A	102-22354
	3/16	102-21307	101-67708	B1402-526-DAL-A	B1402-526-DAR-A	102-22453
	7/32	102-21406	101-67807	102-28559	102-28567	102-22552
	1/4	102-21505	101-67906	B1402-526-FAL-A	B1402-526-FAR-A	102-22651
	9/32	102-21604	101-68003	B1402-526-GAL-A	B1402-526-GAR-A	102-22750
	5/16	102-21703	101-68102	B1402-526-HAL-A	B1402-526-HAR-A	102-22859
	3/8	102-21802	101-68201	B1402-526-KAL-A	B1402-526-KAR-A	102-22958
	7/16	102-21803	101-68300	B1402-526-IAL-A	B1402-526-IAR-A	102-22959
	1/2	102-22008	101-68409	B1402-526-LAL-A	B1402-526-LAR-A	102-23253
	5/8	101-33007	101-68508	102-28856	102-28864	102-23352
	3/4	101-33106	101-68607	102-28955	102-28963	102-23550
	7/8	101-33205	101-68706	102-28956	102-28964	102-23551
	1"	101-33304	101-68805	102-29151	102-29169	102-23758

### 重机双针机针位组 (JUKI)

MODEL	SIZE					
机种	尺寸	NEEDLE PLATE	FEED DOG	NEEDLE CLAMP NEEDLE HOLDER	LH-3128 LH-3178 PRESSER FOOT	LH-3128-S LH-3178-S PRESSER FOOT
		针板	牙齿	针头	压脚	压脚
LH-3128 LH-3178 LH-3128-S LH-3178-S	1/8	226-25107	226-30107	101-47650	101-52551	102-22255
	5/32	226-25206	226-30206	101-47759	101-52650	102-22354
	3/16	226-25305	226-30404	101-47858	101-52759	226-40353
	7/32	226-25404	226-30503	101-47957	101-52858	226-40452
	1/4	226-25503	226-30602	101-48054	101-52957	226-40551
	9/32	226-25602	226-30800	101-48153	101-53054	226-40759
	5/16	226-25701	226-30909	101-48252	101-53153	226-40858
	3/8	226-25800	226-31006	101-48351	101-53252	226-40957
	7/16	226-25909	226-31105	101-48450	101-53351	226-41054
	1/2	226-26006	226-31303	101-48559	101-53450	226-41252
	5/8	226-26105	226-31402	101-48658	101-53559	226-41351
	3/4	226-26204	226-31501	101-48757	101-53658	226-41450
	7/8	226-26303	226-31709	101-48856	101-53757	226-41658
	1"	226-26402	226-31808	101-48955	101-53856	226-41757
	1-1/8	226-26501	226-31907	101-49052	101-53955	226-41856
	1-1/4	226-26600	226-32004	101-49151	101-54052	226-41955
	1-3/8	226-26709	226-32103	101-49250	101-54151	226-42052
	1-1/2	226-26808	226-32202	101-49359	101-54250	226-42151

MODEL	SIZE				
机种	尺寸	NEEDLE PLATE	FEED DOG	NEEDLE HOLDER	PRESSER FOOT
		针板	牙齿	针头	压脚
LH-3128-7 LH-3178-7	1/8	226-60203	102-25704	101-47650	102-22255
	5/32	226-60302	102-37907	101-47759	102-22354
	3/16	226-60401	102-38004	101-47858	226-40353
	7/32	226-60500	102-38103	101-47957	226-40452
	1/4	226-60609	102-38202	101-48054	226-40551
	9/32	226-60708	102-38301	101-48153	226-40759
	5/16	226-60807	102-38400	101-48252	226-40858
	3/8	226-60906	102-38509	101-48351	226-40957
	7/16	226-61003	101-68300	101-48450	226-41054
	1/2	226-61102	102-38707	101-48559	226-41252
	5/8	226-61201	102-38806	101-48658	226-41351
	3/4	226-61300	102-38905	101-48757	226-41450
	7/8	226-61409	101-68706	101-48856	226-41658
	1"	226-61508	102-39002	101-48955	226-41757
	1-1/8	226-61607	101-68904	101-49052	226-41856
	1-1/4	226-61706	101-69001	101-49151	226-41955

### 重机双针机针位组 (JUKI)





MODEL	SIZE						
机种	尺寸	NEEDLE PLATE	FEED DOG	NEEDLE CLAMP (L) NEEDLE HOLDER	NEEDLE CLAMP (R) NEEDLE HOLDER	LH-3162 LH-3168 PRESSER FOOT	LH-3162-S LH-3168-S PRESSER FOOT
		针板	牙齿	针头	针头	压脚	压脚
LH-3162 LH-3168 LH-3162-S LH-3168-S	1/8	226-25107	226-30107	B1402-528-BAL-A	B1402-528-BAR-A	101-52551	102-22255
	5/32	226-25206	226-30206	B1402-528-CAL-A	B1402-528-CAR-A	101-52650	102-22354
	3/16	226-25305	226-30404	B1402-528-DAL-A	B1402-528-DAR-A	101-52759	226-40353
	7/32	226-25404	226-30503	B1402-528-EAL-A	B1402-528-EAR-A	101-52858	226-40452
	1/4	226-25503	226-30602	B1402-528-FAL-A	B1402-528-FAR-A	101-52957	226-40551
	9/32	226-25602	226-30800	B1402-528-GAL-A	B1402-528-GAR-A	101-53054	226-40759
	5/16	226-25701	226-30909	B1402-528-HAL-A	B1402-528-HAR-A	101-53153	226-40858
	3/8	226-25800	226-31006	B1402-528-KAL-A	B1402-528-KAR-A	101-53252	226-40957
	7/16	226-25909	226-31105	B1402-528-IAL-A	B1402-528-IAR-A	101-53351	226-41054
	1/2	226-26006	226-31303	B1402-528-LAL-A	B1402-528-LAR-A	101-53450	226-41252
	5/8	226-26105	226-31402	B1402-528-MAL-A	B1402-528-MAR-A	101-53559	226-41351
	3/4	226-26204	226-31501	B1402-528-NAL-A	B1402-528-NAR-A	101-53658	226-41450
	7/8	226-26303	226-31709	B1402-528-PAL-A	B1402-528-PAR-A	101-53757	226-41658
1"	226-26402	226-31808	B1402-528-QAL-A	B1402-528-QAR-A	101-53856	226-41757	

MODEL	SIZE					
机种	尺寸	NEEDLE PLATE	FEED DOG	NEEDLE HOLDER (L)	NEEDLE HOLDER (R)	PRESSER FOOT
		针板	牙齿	针头	针头	压脚
LH-3128-7 LH-3178-7	1/8	226-60203	102-25704	B1402-528-BAL-A	B1402-528-BAR-A	102-22255
	5/32	226-60302	102-37907	B1402-528-CAL-A	B1402-528-CAR-A	102-22354
	3/16	226-60401	102-38004	B1402-528-DAL-A	B1402-528-DAR-A	226-40353
	7/32	226-60500	102-38103	B1402-528-EAL-A	B1402-528-EAR-A	226-40452
	1/4	226-60609	102-38202	B1402-528-FAL-A	B1402-528-FAR-A	226-40551
	9/32	226-60708	102-38301	B1402-528-GAL-A	B1402-528-GAR-A	226-40759
	5/16	226-60807	102-38400	B1402-528-HAL-A	B1402-528-HAR-A	226-40858
	3/8	226-60906	102-38509	B1402-528-KAL-A	B1402-528-KAR-A	226-40957
	7/16	226-61003	101-68300	B1402-528-IAL-A	B1402-528-IAR-A	226-41054
	1/2	226-61102	102-38707	B1402-528-LAL-A	B1402-528-LAR-A	226-41252
	5/8	226-61201	102-38806	B1402-528-MAL-A	B1402-528-MAR-A	226-41351
	3/4	226-61300	102-38905	B1402-528-NAL-A	B1402-528-NAR-A	226-41450
	7/8	226-61409	101-68706	B1402-528-PAL-A	B1402-528-PAR-A	226-41658
1"	226-61508	102-39002	B1402-528-QAL-A	B1402-528-QAR-A	226-41757	

### 重机双针机针位组 (JUKI)

MODEL	SIZE					
机种	尺寸	NEEDLE PLATE	FEED DOG	NEEDLE HOLDER	NEEDLE HOLDER	PRESSER FOOT
		针板	牙齿	针头	针头	压脚
LH-3188 LH-3182	3/16	226-25305	228-15401	B1402-528-DAL-A	B1402-528-DAR-A	228-16557
	7/32	226-25404	228-15500	B1402-528-EAL-A	B1402-528-EAR-A	228-16656
	1/4	226-25503	228-15609	B1402-528-FAL-A	B1402-528-FAR-A	228-16755
	9/32	226-25602	228-15708	B1402-528-GAL-A	B1402-528-GAR-A	228-16854
	5/16	226-25701	228-15807	B1402-528-HAL-A	B1402-528-HAR-A	228-16953
	3/8	226-25800	228-15906	B1402-528-KAL-A	B1402-528-KAR-A	228-17050
	1/2	226-26006	228-16003	B1402-528-LAL-A	B1402-528-LAR-A	228-17159
	3/16	226-60401	228-21201	B1402-528-DAL-A	B1402-528-DAR-A	228-16557
	7/32	226-60500	228-21300	B1402-528-EAL-A	B1402-528-EAR-A	228-16656
	1/4	226-60609	228-21409	B1402-528-FAL-A	B1402-528-FAR-A	228-16755
LH-3188-7 LH-3182-7	9/32	226-60708	228-21508	B1402-528-GAL-A	B1402-528-GAR-A	228-16854
	5/16	226-60807	228-21607	B1402-528-HAL-A	B1402-528-HAR-A	228-16953
	3/8	226-60906	228-21706	B1402-528-KAL-A	B1402-528-KAR-A	228-17050
	21/2	226-61102	228-21805	B1402-528-LAL-A	B1402-528-LAR-A	228-17159

MODEL	SIZE				
机种	尺寸	NEEDLE PLATE 针板	FEED DOG 牙齿	NEEDLE CLAMP 针头	PRESSER FOOT 压脚
DN-260	1/32	MN MN 10J1 101	MN MN 10J1 104	MN MN 10J1 102	MN MN 10J1 105
	1/16	MN MN 10J2 101	MN MN 10J2 104	MN MN 10J2 102	MN MN 10J2 105
	3/32	MN MN 10J3 101	MN MN 10J3 104	MN MN 10J3 102	MN MN 10J3 105
	1/8	MN MN 10J4 101	MN MN 10J4 104	MN MN 10J4 102	MN MN 10J4 105
	5/32	MN MN 10J5 101	MN MN 10J5 104	MN MN 10J5 102	MN MN 10J5 105
	3/16	MN MN 10J6 101	MN MN 10J6 104	MN MN 10J6 102	MN MN 10J6 105
	7/32	MN MN 10J7 101	MN MN 10J7 104	MN MN 10J7 102	MN MN 10J7 105
	1/4	MN MN 10J8 101	MN MN 10J8 104	MN MN 10J8 102	MN MN 10J8 105
	9/32	MN MN 10J8 101	MN MN 10J8 104	MN MN 10J8 102	MN MN 10J8 105
	5/16	MN MN 10J9 101	MN MN 10J9 104	MN MN 10J9 102	MN MN 10J9 105
	11/32	MN MN 10J9 101A	MN MN 10J9 104A	MN MN 10J9 102A	MN MN 10J9 105A
	3/8	MN MN 10K1 101	MN MN 10K1 104	MN MN 10K1 102	MN MN 10K1 105
	13/32	MN MN 10K1 101A	MN MN 10K1 104A	MN MN 10K1 102A	MN MN 10K1 105A
	7/16	MN MN 10K2 101	MN MN 10K2 104	MN MN 10K2 102	MN MN 10K2 105
	15/32	MN MN 10K2 101A	MN MN 10K2 104A	MN MN 10K2 102A	MN MN 10K2 105A
	1/2	MN MN 10K3 101	MN MN 10K3 104	MN MN 10K3 102	MN MN 10K3 105
	17/32	MN MN 10K3 101A	MN MN 10K3 104A	MN MN 10K3 102A	MN MN 10K3 105A
	9/16	MN MN 10K3 101B	MN MN 10K3 104B	MN MN 10K3 102B	MN MN 10K3 105B
	19/32	MN MN 10K3 101C	MN MN 10K3 104C	MN MN 10K3 102C	MN MN 10K3 105C
	5/8	MN MN 10K4 101	MN MN 10K4 104	MN MN 10K4 102	MN MN 10K4 105
	11/16	MN MN 10K4 101A	MN MN 10K4 104A	MN MN 10K4 102A	MN MN 10K4 105A
	3/4	MN MN 10K5 101	MN MN 10K5 104	MN MN 10K5 102	MN MN 10K5 105
	13/16	MN MN 10K5 101A	MN MN 10K5 104A	MN MN 10K5 102A	MN MN 10K5 105A
	7/8	MN MN 10K5 101B	MN MN 10K5 104B	MN MN 10K5 102B	MN MN 10K5 105B
	15/16	MN MN 10K5 101C	MN MN 10K5 104C	MN MN 10K5 102C	MN MN 10K5 105C
	1"	MN MN 10K6 101	MN MN 10K6 104	MN MN 10K6 102	MN MN 10K6 105
	1-1/16	MN MN 10K6 101A	MN MN 10K6 104A	MN MN 10K6 102A	MN MN 10K6 105A
	1-1/8	MN MN 10K7 101	MN MN 10K7 104	MN MN 10K7 102	MN MN 10K7 105
	1-3/16	MN MN 10K7 101A	MN MN 10K7 104A	MN MN 10K7 102A	MN MN 10K7 105A
	1-1/4	MN MN 10K8 101	MN MN 10K8 104	MN MN 10K8 102	MN MN 10K8 105
	1-5/16	MN MN 10K8 101A	MN MN 10K8 104A	MN MN 10K8 102A	MN MN 10K8 105A
	1-3/8	MN MN 10K8 101B	MN MN 10K8 104B	MN MN 10K8 102B	MN MN 10K8 105B
1-7/16	MN MN 10K8 101C	MN MN 10K8 104C	MN MN 10K8 102C	MN MN 10K8 105C	
1-1/2	MN MN 10K9 101	MN MN 10K9 104	MN MN 10K9 102	MN MN 10K9 105	
1-9/16	MN MN 10K9 101A	MN MN 10K9 104A	MN MN 10K9 102A	MN MN 10K9 105A	
1-5/8	MN MN 10K9 101B	MN MN 10K9 104B	MN MN 10K9 102B	MN MN 10K9 105B	
1-11/16	MN MN 10K9 101C	MN MN 10K9 104C	MN MN 10K9 102C	MN MN 10K9 105C	
1-3/4	MN MN 10K9 101D	MN MN 10K9 104D	MN MN 10K9 102D	MN MN 10K9 105D	
1-7/8	MN MN 10K9 101E	MN MN 10K9 104E	MN MN 10K9 102E	MN MN 10K9 105E	
1-15/16	MN MN 10K9 101F	MN MN 10K9 104F	MN MN 10K9 102F	MN MN 10K9 105F	
2"	MN MN 10K9 101G	MN MN 10K9 104G	MN MN 10K9 102G	MN MN 10K9 105G	

MODEL	SIZE				
机种	尺寸	NEEDLE PLATE 针板	FEED DOG 牙齿	NEEDLE CLAMP 针头	PRESSER FOOT 压脚
LT2-2220-MOB	3/32	MN 10J3 101	MN 57J2 104	MN 10J3 102	MN 10J3 105
	1/8	MN 10J4 101	MN 57J3 104	MN 10J4 102	MN 10J4 105
	5/32	MN 10J5 101	MN 57J4 104	MN 10J5 102	MN 10J5 105
	3/16	MN 10J6 101	MN 57J5 104	MN 10J6 102	MN 10J6 105
	7/32	MN 10J7 101	MN 57J6 104	MN 10J7 102	MN 10J7 105
	1/4	MN 10J8 101	MN 57J7 104	MN 10J8 102	MN 10J8 105
	5/16	MN 10J9 101	MN 57J9 104	MN 10J9 102	MN 10J9 105
	3/8	MN 10K1 101	MN 57K1104	MN 10K1 102	MN 10K1 105
	1/2	MN 10K3 101	MN 57K3 104	MN 10K3 102	MN 10K3 105
	5/8	MN 10K4 101	MN 57K5104	MN 10K4 102	MN 10K4 105
	3/4	MN 10K5 101	MN 57K6 104	MN 10K5 102	MN 10K5 105
	1"	MN 10K6 101	MN 57K8 104	MN 10K6 102	MN 10K6 105
	1-1/8	MN 10K7 101	MN 57K9 104	MN 10K7 102	MN 10K7 105
	1-1/4	MN 10K8 101	MN 58K1 104	MN 10K8 102	MN 10K8 105
	1-1/2	MN 10K9 101	MN 58K3 104	MN 10K9 102	MN 10K9 105

MODEL	SIZE					
机种	尺寸	NEEDLE PLATE 针板	FEED DOG 牙齿	NEEDLE CLAMP 针头	PRESSER FOOT (INSIDE) 压脚	PRESSER FOOT (OUTSIDE) 压脚
LU2-420 DU-122	1/8	MP 20J4 101	MP 20J4 104	MP 20J4 102	MP 20J4 107	MP 20J4 106
	5/32	MP 20J5 101	MP 20J5 104	MP 20J5 102	MP 20J5 107	MP 20J5 106
	3/16	MP 20J6 101	MP 20J6 104	MP 20J6 102	MP 20J6 107	MP 20J6 106
	7/32	MP 20J7 101	MP 20J7 104	MP 20J7 102	MP 20J7 107	MP 20J7 106
	1/4	MP 20J8 101	MP 20J8 104	MP 20J8 102	MP 20J8 107	MP 20J8 106
	9/32	MP 20J8 101A	MP 20J8 104A	MP 20J8 102A	MP 20J8 107A	MP 20J8 106A
	5/16	MP 20J9 101	MP 20J9 104	MP 20J9 102	MP 20J9 107	MP 20J9 106
	3/8	MP 20K1 101	MP 20K1 104	MP 20K1 102	MP 20K1 107	MP 20K1 106
	7/16	MP 20K2 101	MP 20K2 104	MP 20K2 102	MP 20K2 107	MP 20K2 106
	1/2	MP 20K3 101	MP 20K3 104	MP 20K3 102	MP 20K3 107	MP 20K3 106
	9/16	MP 20K3 101B	MP 20K3 104B	MP 20K3 102B	MP 20K3 107B	MP 20K3 106B
	5/8	MP 20K4 101	MP 20K4 104	MP 20K4 102	MP 20K4 107	MP 20K4 106
	11/16	MP 20K4 101A	MP 20K4 104A	MP 20K4 102A	MP 20K4 107A	MP 20K4 106A
	3/4	MP 20K5 101	MP 20K5 104	MP 20K5 102	MP 20K5 107	MP 20K5 106
	13/16	MP 20K5 101A	MP 20K5 104A	MP 20K5 102A	MP 20K5 107A	MP 20K5 106A
	7/8	MP 20K5 101B	MP 20K5 104B	MP 20K5 102B	MP 20K5 107B	MP 20K5 106B
	1"	MP 20K6 101	MP 20K6 104	MP 20K6 102	MP 20K6 107	MP 20K6 106
	1-1/8	MP 20K7 101	MP 20K7 104	MP 20K7 102	MP 20K7 107	MP 20K7 106
	1-1/4	MP 20K8 101	MP 20K8 104	MP 20K8 102	MP 20K8 107	MP 20K8 106
	1-3/8	MP 20K8 101B	MP 20K8 104B	MP 20K8 102B	MP 20K8 107B	MP 20K8 106B
	1-1/2	MP 20K9 101	MP 20K9 104	MP 20K9 102	MP 20K9 107	MP 20K9 106
	1-5/8	MP 20K9 101B	MP 20K9 104B	MP 20K9 102B	MP 20K9 107B	MP 20K9 106B
	1-3/4	MP 20K9 101D	MP 20K9 104D	MP 20K9 102D	MP 20K9 107D	MP 20K9 106D

### 重机针位组 (JUKI)

MODEL	SIZE					
机种	尺寸	NEEDLE PLATE 针板	FEED DOG 牙齿	NEEDLE HOLDER 针头	PRESSER FOOT (薄) 压(薄)	PRESSER FOOT (厚) 带刀压脚(厚)
MH-38	1/8	B1103-038-B00	B1605-038-B00	B1406-038-B00	B1509-038-BB0	*
MH-38	3/16	B1103-038-D00	B1605-038-D00	B1406-038-D00	B1509-038-DB0	*
MH-38	1/4	B1103-038-F00	B1605-038-F00	B1406-038-F00	B1509-038-FB0	*
MH-38-2	*	D1103-038-B00	D1605-038-B00	D1406-038-B00	D1509-038-BA0	*
MH-380	3/16	B1103-380-D00	B1613-380-D00	B1406-019-DA0	B1509-038-DB0	3/16 (1/16 1/32) L/R
MH-380	1/4	B1103-380-F00	B1613-380-F00	B1406-019-FA0	B1509-038-FB0	1/4 (1/16 1/32) L/R
MH-380	5/16	B1103-380-H00	B1613-380-H00	B1406-019-HA0	B1509-038-HB0	5/16 (1/16 1/32) L/R
MH-380	3/8	B1103-380-K00	B1613-380-K00	B1406-019-KA0	B1509-038-KB0	3/8 (1/16 1/32) L/R
MH-380	1/2	B1103-380-L00	B1613-380-L00	B1406-019-LA0	B1509-038-LB0	1/2 (1/16 1/32) L/R
MH-382	*	D1103-380-D00	D1613-380-D00	D1406-019-DA0	D1509-038-DA0	*

MODEL	SIZE				
机种	尺寸	NEEDLE PLATE 针板	FEED DOG 牙齿	NEEDLE HOLDER 针头	PRESSER FOOT 压脚
MS-19	1/8	B1108-019-B00	B1604-019-B00	B1406-019-BA0	B1507-019-BA0
	3/16	B1108-019-D00	B1604-019-D00	D1406-019-DA0	B1507-019-DA0
	1/4	B1108-019-F00	B1604-019-F00	B1406-019-FA0	B1507-019-FA0
	3/8	B1108-019-K00	B1604-019-K00	B1406-019-KA0	B1507-019-KA0

MODEL	SIZE				
机种	尺寸	NEEDLE PLATE 针板	FEED DOG 牙齿	NEEDLE HOLDER 针头	PRESSER FOOT 压脚
MS-1190	3/16	129-23405	129-32307	129-25954	129-27760
	FG 3/16				
	1/4	129-23801	129-32406	129-26358	129-28164
	FG 1/4				
MS-1190M	3/16	129-80405	129-83508	129-25954	129-82567
	FG 3/16				
	1/4	129-80801	129-83607	129-26358	129-82963
	FG 1/4				





### 重机针位组 (JUKI)

MODEL	SIZE				
机种	尺寸	NEEDLE PLATE 针板	FEED DOG 牙齿	NEEDLE HOLDER 针头	PRESSER FOOT 压脚
MS-26	1/4	B1108-026-F00	B1604-026-A00	B1406-026-FA0	B1507-026-FA0
MS-1260	3/16	129-77807	129-78656	129-25954	129-77054
MS-1261 V045	3/16	129-53204	129-63351	129-56256	129-60068
MS-1261	1/4	129-53204	129-63351	129-56256	129-57064
	FG 1/4				
MS1261M	1/4	129-54509	129-69952	129-56256	129-56066
	FG21/4				



MODEL	SIZE						
机种	尺寸	NEEDLE PLATE 针板	FEED DOG 牙齿	NEEDLE CLAMP 针头	PRESSER FOOT 压脚	LOOPER HOLDER 弯针座	NEEDLE GUARD 针傍
1410	1/4*7/8*1/4	针板	牙齿	针头	压脚	弯针座	针傍
	1/4*1**1/4	针板	牙齿	针头	压脚	弯针座	针傍
	1/4*1-1/4*1/4	针板	牙齿	针头	压脚	弯针座	针傍
	3/16*1*3/16	针板	牙齿	针头	压脚	弯针座	针傍

### 兄弟埋夹机针位组 (BROTHER)

MODEL	SIZE				
机种	尺寸	NEEDLE PLATE 针板	FEED DOG 牙齿	NEEDLE HOLDER 针头	PRESSER FOOT 压脚
DT6-B925	3/16*2N	105403-0-01	105404-0-01	181077-0-01	101491-0-01
	1/4*2N	101554-0-01	101557-0-01	181074-0-01	101555-0-01
DT6-B926	1/8*3N	111130-0-01	111154-0-01	181079-0-01	111143-0-01

MODEL	SIZE				
机种	尺寸	NEEDLE PLATE 针板	FEED DOG 牙齿	NEEDLE HOLDER 针头	PRESSER FOOT 压脚
DT6-B926-6A	1/8 (2N)	148864-0-01	148867-0-01	181716-0-01	148865-0-01
DT6-B928-6A					148865-2-01
DT6-B926-6A	3/16 (2N)	针板3/16	牙齿3/16	针头3/16	压脚3/16
DT6-B928-6A					压脚3/16
DT6-B926-6A	1/4 (2N)	针板1/4	牙齿1/4	针头1/4	压脚1/4
DT6-B928-6A					压脚1/4
DT6-B926-6A	5/16 (2N)	针板5/16	牙齿5/16	针头5/16	压脚5/16
DT6-B928-6A					压脚5/16
DT6-B926-6A	3/8 (2N)	针板3/8	牙齿3/8	针头3/8	压脚3/8
DT6-B928-6A					压脚3/8

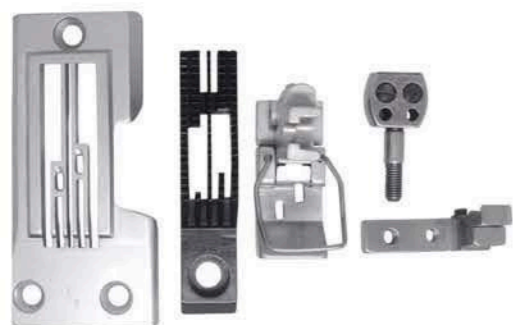

B925针位/Needle gauge



B926-6A针位/Needle gauge

### 兄弟埋夹机针位组 (BROTHER)

MODEL	SIZE				
机种	尺寸	NEEDLE PLATE 针板	FEED DOG 牙齿	NEEDLE HOLDER 针头	PRESSER FOOT 压脚
DT6-B926-8A	1/8 (2N)	150667-0-01	150675-0-01	181716-0-01	150672-0-01
DT6-B928-8A					150672-1-01
DT6-B926-8A	3/16 (2N)	针板3/16	牙齿3/16	针头3/16	压脚3/16
DT6-B928-8A					压脚3/16
DT6-B926-8A	1/4 (2N)	针板1/4	牙齿1/4	针头1/4	压脚1/4
DT6-B928-8A					压脚1/4
DT6-B926-8A	5/16 (2N)	针板5/16	牙齿5/16	针头5/16	压脚5/16
DT6-B928-8A					压脚5/16
DT6-B926-8A	3/8 (2N)	针板3/8	牙齿3/8	针头3/8	压脚3/8
DT6-B928-8A					压脚3/8

MODEL	SIZE				
机种	尺寸	NEEDLE PLATE 针板	FEED DOG 牙齿	NEEDLE HOLDER 针头	PRESSER FOOT 压脚
DT6-B927	3/16 (2N)	S05946-1-01	S40369-0-01	183954-0-01	S40355-0-01
	1/4 (2N)	S11508-1-01	S40370-0-01	153978-0-01	106160-1-01



B926-8A针位/Needle gauge



B927针位/Needle gauge

MODEL	SIZE					
机种	尺寸	NEEDLE PLATE 针板	DIFF FEED DOG 牙齿	MAIN FEED DOG 牙齿	NEEDLE HOLDER 针头	PRESSER FOOT 压脚
35800BQ	1/4 3/16	35824BQ-9	35826DQ	35805DQ-9	35818BY-9	35820BQ-9
35800BQ-A	1/4 3/16	35824BQ-9	*	35805BQ-9	35818BY-9	35820BQ-9
35800BR	1/4 3/16	35824DQ-9	35826DR	35805DR-9	35818BY-9	35830BX-9
35800BR-A	1/4 3/16	35824DQ-9	*	35805BR-9	35818BY-9	35830BX-9
35800BX	1/4 3/16	35828BX-9	*	35826BX-8	35818BY-9	35830BX-9
35800DN	1/4 3/16	35824DN-9	35826DP	35805DP-8	35818BY-9	35830-DM-9
35800DN-A	3/16 1/4 5/16 3/8 1/22	35824DN-9	*	35805DN-9	35818BY-9	35830-DM-9
35800DM	1/4 3/16	35828DM-8	*	35826DM-8	35818BY-8	35820AD-12



35800DM针位/Needle gauge





35800DN-A针位/Needle gauge







35800DN针位/Needle gauge

MODEL					
机种	NEEDLE PLATE 针板	DIFF FEED DOG 牙齿	MAIN FEED DOG 牙齿	NEEDLE CLAMP 针头	PRESSER FOOT 压脚
DC-1 DCM-201	137135A	137455	137456		137160
DCM-204	140135(200954)	140455(200963)			140160(200970)
DCP-101	200044A	200318A	200229A		200113
DC-MS230	200715A	200723A		200713	200731
U32-30-3*3	204294B	204254B	204125B	204037A	204167B
U32-30-3*4	204039B	204254B	204125B	204037A	204167B
U32-30-3*5	204252B	204254B	204125B	204037A	204167B
U32-30-3*6	204295B	204254B	204125B	204037A	204167B
U32-31-3*3	204294B	204250B	204248B	204037A	204167B
U32-31-3*4	204039B	204250B	204248B	204037A	204167B
U32-31-3*5	204252B	204250B	204248B	204037A	204167B
U32-31-3*6	204295B	204250B	204248B	204037A	204167B
U32-34-3*3	204294B	204408	204394	204037A	204167B
U32-34-3*4	204039B	204408	204394	204037A	204167B
U32-34-3*5	204252B	204408	204394	204037A	204167B
U32-34-3*6	204295B	204408	204394	204037A	204167B
L32-30-3*3					
L32-32-3*3	204294B	2081216	208062	208909	208501
L32-30-3*4					
L32-32-3*4	204039B	2081216	208062	208909	208501
L32-30-3*5					
L32-32-3*5	204252B	2081216	208062	208909	208501
L32-30-3*6					
L32-32-3*6	204295B	2081216	208062	208909	208501
L32-31-3*3					
L32-33-3*3	204294B	208215	208063	208909	208501
L32-31-3*4					
L32-33-3*4	204039B	208215	208063	208909	208501
L32-31-3*5					
L32-33-3*5	204252B	208215	208063	208909	208501
L32-31-3*6					
L32-33-3*6	204295B	208215	208063	208909	208501
L32-34-3*3					
L32-35-3*3	204294B	208217	208064	208909	208501
L32-34-3*4					
L32-35-3*4	204039B	208217	208064	208909	208501
L32-34-3*5					
L32-35-3*5	204252B	208217	208064	208909	208501
L32-34-3*6					
L32-35-3*6	204295B	208217	208064	208909	208501
L32-36-3*3					
L32-37-3*3	204366	208218	208065	208909	208504
L32-36-3*4					
L32-37-3*4	204367	208218	208065	208909	208504





飞马包缝机针位 (PEGASUS)

MODEL					
机种	NEEDLE PLATE 针板	DIFF FEED DOG 牙齿	MAIN FEED DOG 牙齿	NEEDLE CLAMP 针头	PRESSER FOOT 压脚
L32-36-3*5	204368	208218	208065	208909	208504
L32-37-3*5					
L32-36-3*6	204369	208218	208065	208909	208504
L32-37-3*6					
L32-38-3*3	204366	208219	208066	208909	208504
L32-39-3*3					
L32-38-3*4	204367	208219	208066	208909	208504
L32-39-3*4					
L32-38-3*5	204368	208219	208066	208909	208504
L32-39-3*5					
L32-38-3*6	204369	208219	208066	208909	208504
L32-39-3*6					
L32-40-3*3	204366	208220	208067	208909	208504
L32-41-3*3					
L32-40-3*4	204367	208220	208067	208909	208504
L32-41-3*4					
L32-40-3*5	204368	208220	208067	208909	208504
L32-41-3*5					
L32-40-3*6	204369	208220	208067	208909	208504
L32-41-3*6					
L32-48-3*3	204939	204420	208074	208909	208508
L32-49-3*3					
L32-48-3*4	204940	204420	208074	208909	208508
L32-49-3*4					
L32-48-3*5	204941	204420	208074	208909	208508
L32-49-3*5					
L32-48-3*6	204942	204420	208074	208909	208508
L32-49-3*6					
L32-70-5*3	204358A	208215	208063	208910	208502
L32-71-5*3					
L32-70-5*4	204359A	208215	208063	208910	208502
L32-71-5*4					
L32-70-5*5	204360A	208215	208063	208910	208502
L32-71-5*5					
L32-70-5*6	204361A	208215	208063	208910	208502
L32-71-5*6					
L32-72-5*3	204358A	208217	208064	208910	208502
L32-73-5*3					
L32-72-5*4	204359A	208217	208064	208910	208502
L32-73-5*4					
L32-72-5*5	204360A	208217	208064	208910	208502
L32-73-5*5					
L32-72-5*6	204361A	208217	208064	208910	208502
L32-73-5*6					
L32-74-5*5	204380	208224	208063	208910	208502
L32-76-5*5	204380	208225	208064	208910	208502
L32-78-5*3	204943	204422	208076	208910	208509
L32-79-5*3					
L32-78-5*4	204944	204422	208076	208910	208509
L32-79-5*4					





飞马包缝机针位 (PEGASUS)

MODEL					
机种	NEEDLE PLATE 针板	DIFF FEED DOG 牙齿	MAIN FEED DOG 牙齿	NEEDLE CLAMP 针头	PRESSER FOOT 压脚
L32-78-5*5	204945	204422	208076	208910	208509
L32-79-5*5					
L32-78-5*6	204946	204422	208076	208910	208509
L32-79-5*6					
L32-86-5*5	204528	208217	208064	208910	208506
L32-87-5*5					
L32-86-5*6	204529	208217	208064	208910	208506
L32-87-5*6					
L32-88-5*5	204700	208225	208064	208910	208506
L32-355-3*2*3					
L32-359-3*2*3	208674	208219	208066	208965	208649
L32-355-3*2*4					
L32-359-3*2*4	208648	208219	208066	208965	208649
L32-555-5*2*3					
L32-559-5*2*3	208675	208215	208063	209254	209255
L32-555-5*2*4					
L32-559-5*2*4	207676	208215	208063	209254	209255
L32-36A-3*3					
L32-37A-3*4	204366	208218	208065	208909	211909
L32-36B-3*5	204367	208218	208065	208909	211909
L32-37B-3*6	204368	208218	208065	208909	211910
L32-38A-3*3	204369	208218	208065	208909	211910
L32-38A-3*4	204366	208219	208066	208909	211909
L32-39A-3*4	204367	208219	208066	208909	211909
L32-38B-3*5	204368	208219	208066	208909	211910
L32-39B-3*6	204369	208219	208066	208909	211910
L52-01-0*2	209298	204730-BF	208090-BF	*	201152E (201155C)
L52-01-0*3	209299	204730-BF	208090-BF	*	201152E (201155C)
L52-01-0*4	205773	204730-BF	208090-BF	*	201152E (201155C)
L52-01S-0*2	202616	204977-BF	208090-BF	*	201152E (201155C)
L52-01S-0*3	202617	204977-BF	208090-BF	*	201152E (201155C)
L52-01S-0*4	202618	204977-BF	208090-BF	*	201152E (201155C)
L52-02-0*2	209298	204730-BF	208090-BF	*	201473B (201224B)
L52-02-0*3	208299	204730-BF	208090-BF	*	201473B (201224B)
L52-02-0*4	205773	204730-BF	208090-BF	*	201473B (201224B)
L52-12-2*2	208753	204690-BF	208078-BF	208905	208730A
L52-12-2*3	205255	204690-BF	208078-BF	208905	208730A
L52-12-2*4	202554E	204690-BF	208078-BF	208905	208730A
L52-16S2-0*1.5	205465	204730	208911	*	201230C (205525)
L52-17-0*4	202546E	204676-BF	208078-BF	*	201230C (201224B)
L52-28-0*4	202546E	204690-BF	208078-BF	*	201230C (201224B)
L52-26-0*4	202546E	204691-BF	208080-BF	*	201230C (201224B)
L52-27-0*4	202546E	204679-BF	208080-BF	*	201230C (201224B)
L52-11-2*2	208753	204676-BF	208080-BF	208905	201230C (201396B)
L52-11-2*3	205255	204676-BF	208078-BF	208905	201230C (201396B)
L52-11-2*4	202554E	204676-BF	208078-BF	208905	201230C (201310A)
L52-13A-2*2	208753	204676-BF	208078-BF	208905	201230C (201396B)
L52-13A-2*3	205255	204676-BF	208078-BF	208905	201230C (201396B)
L52-13A-2*4	202554E	204676-BF	208078-BF	208905	201230C (201310A)
L52-13-2*2	208753	204676-BF	208078-BF	208905	208730A
L52-13-2*3	205255	204676-BF	208078-BF	208905	208730A





### 飞马包缝机针位 (PEGASUS)

MODEL					
机种	NEEDLE PLATE 针板	DIFF FEED DOG 牙齿	MAIN FEED DOG 牙齿	NEEDLE CLAMP 针头	PRESSER FOOT 压脚
L52-13-2*4	202554E	204676-BF	208078-BF	208905	208730A
L52-23-2*2	208753	204691-BF	208080-BF	208905	208730A
L52-23-2*3	205255	204691-BF	208080-BF	208905	208730A
L52-23-2*4	202554E	204691-BF	208080-BF	208905	208730A
L52-23A-2*2	208753	204691-BF	208080-BF	208905	201230C (201396B)
L52-23A-2*3	205255	204691-BF	208080-BF	208905	201230C (201396B)
L52-23A-2*4	202554E	204691-BF	208080-BF	208905	201230C (201310A)
L52-51-2*4	205243	204676-BF	208079-BF	208905	205253 (201310A)
L52-52-2*4					
E32-420-3*3/516-213-3*3	210837	210492	210579	210273	208504
E32-420-3*4/516-213-3*4	210838	210492	210579	210273	208504
E32-420-3*5/516-213-3*5	210839	210492	210579	210273	208504
E32-420-3*6/516-213-3*6	210840	210492	210579	210273	208504
E32-420A-3*3/516-213-3*3	210837	210492	210579	210273	211909
E32-420B-3*3/516-213-3*3					
E32-420A-3*4/516-213-3*4	210838	210492	210579	210273	21909
E32-420B-3*4/516-213-3*4					
E32-420A-3*5/516-213-3*5	210839	210492	210579	210273	211910
E32-420B-3*5/516-213-3*5					
E32-420A-3*6/516-213-3*6	210840	210492	210579	210273	211910
E32-420B-3*6/516-213-3*6					
E32-430-3*3/516-233-3*3	210845	210494	210581	210273	208501
E32-430-3*4/516-233-3*4	210846	210494	210581	210273	208501
E32-430-3*5/516-233-3*5	210847	210494	210581	210273	208501
E32-430-3*6/516-233-3*6	210848	210494	210581	210273	208501
E32-430-5*3/516-233-5*3	210849	210494	210581	210274	208502
E32-430-5*4/516-233-5*4	210850	210494	210581	210274	208502
E32-430-5*5/516-233-5*5	210851	210494	210581	210274	208502
E32-430-5*6/516-233-5*6	210852	210494	210581	210274	208502
E32-440-3*3/516-255-3*3	210859	210498	210582	210273	208501
E32-440-3*4/516-255-3*4	210860	210498	210582	210273	208501
E32-440-3*5/516-255-3*5	210861	210498	210582	210273	208501
E32-440-3*6/516-255-3*6	210862	210498	210582	210273	208501
E32-440-5*3/516-255-5*3	210863	210501	210582	210274	208502
E32-440-5*4/516-255-5*4	210864	210501	210582	210274	208502
E32-440-5*5/516-255-5*5	210865	210501	210582	210274	208502
E32-440-5*6/516-255-5*6	210866	210501	210582	210274	208502
E32-450-5*5/516-335-5*5	210853	210495	210582	210274	208955
E32-452-5*5/516-435-5*5	210853	210495	210582	210274	208955
E32-450-5*6/516-335-5*6	210854	210495	210582	210274	208955
E32-452-5*6/516-435-5*6	210854	210495	210582	210274	208955
E32-451-5*5/516-355-5*5	210867	210501	210582	210274	208955
E32-453-5*5/516-455-5*5	210867	210501	210582	210274	208955
E32-451-5*6/516-355-5*6	210868	210501	210582	210274	208955
E32-453-5*6/516-455-5*6	210868	210501	210582	210274	208955
E32-542-3*3/516-253-3*3	210980	210957-PG	211002	210273	208508
E32-542-3*4/516-253-3*4	210981	210957-PG	211002	210273	208508
E32-542-3*5/516-253-3*5	210982	210957-PG	211002	210273	208508
E32-542-3*6/516-253-3*6	210983	210957-PG	211002	210273	208508
E32-542-5*3/516-253-5*3	210984	210957-PG	211003	210274	208509





### 飞马包缝机针位 (PEGASUS)

MODEL					
机种	NEEDLE PLATE 针板	DIFF FEED DOG 牙齿	MAIN FEED DOG 牙齿	NEEDLE CLAMP 针头	PRESSER FOOT 压脚
E32-542-5*4/516-253-5*4	210985	210957-PG	211003	210274	208509
E32-542-5*4/516-253-5*5	210986	210957-PG	211003	210274	208509
E32-542-5*6/516-253-5*6	210987	210957-PG	211003	210274	208509
E32-355-3*2*4 (E32-359-3*2*4)	211570	210492	210579	211573	208649
E32-555-5*2*4 (E32-559-5*2*4)	211575	210494	210581	211577	209255
E52-130-0*3/504-253W-0*3	210799	210445	210575	211358	205253/210370
E52-130-0*4	210800	210445	210575	211358	205253/210371
504-253W-0*4	210800	210445	210575	211358	205253/210371
E52-130-0*5	210801	210445	210575	211358	205253/210371
504-253W-0*5	210801	210445	210575	211358	205253/210371
E52-130/504-263N-0*4	210796	210445-BF	210574-BF	211358	201230C (210371)
E52-130T/504-263N-0*4	210796	210445-BF	210574-BF	211358	201230C (210371)
E52-141/504-263N-0*4	210796	210445-BF	210574-BF	211358	201230C (210371)
E52-130/504-263N-0*5	210797	210445-BF	210574-BF	211358	201230C (210371)
E52-130/504-263N-0*5	210797	210445-BF	210574-BF	211358	201230C (210371)
E52-141/504-263N-0*5	210797	210445-BF	210574-BF	211358	201230C (210371)
E52-131M/512-353W-2*4	210809	210445-BF	210575-BF	211360	205253/210374
E52-131M/514-353W-2*5	210810	210445-BF	210575-BF	211360	205253/210374
E52-131MP/514-353W-2*4	210809	210445-BF	210575-BF	211360	205253P
E52-132M/514-363W-2*3	210804	210445-BF	210574-BF	211360	201230C/210503
E52-133M/514-363N-2*3	210804	210445-BF	210574-BF	211360	201230C/210503
E52-142/512-463W-2*3	210804	210445-BF	210574-BF	211360	201230C/210503
E52-142/514-463W-2*3	210804	210445-BF	210574-BF	211360	201230C/210503
E52-132M/514-363W-2*4	210805-PG	210445-BF	210574-BF	211360	201230C/210374
E52-133M/514-363N-2*4	210805-PG	210445-BF	210574-BF	211360	201230C/210374
E52-142/512-463W-2*4	210805-PG	210445-BF	210574-BF	211360	201230C/210374
E52-142/514-463W-2*4	210805-PG	210445-BF	210574-BF	211360	201230C/210374
E52-134/504-233W-0*3	210786	210443	210697	211358	202799/210370
E52-134/504-233W-0*4	210787	210443	210697	211358	202799/210371
E52-134/504-233W-0*5	210788	210443	210697	211358	202799/210371
E52-210/505-223N-0*3	210783	210442-BF	210569-BF	211358	201152E/201155C
E52-211/503-223N-0*3	210783	210442-BF	210569-BF	211358	201152E/201155C
E52-210/505-223N-0*4	210784	210442-BF	210569-BF	211358	201152E/201155C
E52-211/503-223N-0*4	210784	210442-BF	210569-BF	211358	201152E/201155C
E52-220/503-233W-0*3	210786	210443	210568-PG	211358	202799/210370
E52-220/503-233W-0*4	210787	210443	210568-PG	211358	202799/210371
E52-220/503-233W-0*5	210788	210443	210568-PG	211358	202799/210371
E52-221/504-365W-0*4	210796	210446	210576	211358	201230C/210371
E52-221/504-365W-0*5	210797	210446	210576	211358	201230C/210371
E52-231/504-223N-0*1.5	210934	210442-BF	211290-BF	211358	201230C/205525
E52-242/504-253W-0*3	210799	210959-PG	210996	211358	205135
E52-242/504-253W-0*4	210800	210959-PG	210996	211358	205135
E52-242/504-253W-0*5	210801	210959-PG	210996	211358	205136
E52-242/504-263W-0*4	210796	210959-PG	210997	211358	205135
E52-242/504-263W-0*5	210797	210959-PG	210997	211358	205136
E52-243M/512-353W-2*3	210808	210959-PG	210996	211360	205136
E52-243M/514-353W-2*3	210808	210959-PG	210996	211360	205136
E52-243M/512-353W-2*4	210809	210959-PG	210996	211360	205136

飞马包缝机针位 (PEGASUS)

MODEL					
机种	NEEDLE PLATE 针板	DIFF FEED DOG 牙齿	MAIN FEED DOG 牙齿	NEEDLE CLAMP 针头	PRESSER FOOT 压脚
E52-243M/514-353W-2*4	210809	210959-PG	210996	211360	205136
E52-243M/512-353W-2*5	210810	210959-PG	210996	211360	205136
E52-243M/514-353W-2*5	210810	210959-PG	210996	211360	205136
E52-243M/512-363W-2*3	210804	210959-PG	210997	211360	205136
E52-243M/514-363W-2*3	210804	210959-PG	210997	211360	205136
E52-243M/512-363W-2*4	210805-PG	210959-PG	210997	211360	205136
E52-243M/514-363W-2*4	210805-PG	210959-PG	210997	211360	205136
E52-250M/512-363N-2*3	210804	210445-BF	210574-BF	211360	208730A
E52-250MC/514-363N-2*3	210804	210445-BF	210574-BF	211360	208730A
E52-250M/512-363N-2*4	210805-PG	210445-BF	210574-BF	211360	208730A
E52-250MC/514-363N-2*4	210805-PG	210445-BF	210574-BF	211360	208730A
E56-130/504-253W-0*3	210799	210445	210575	*	205253/210370
E56-130/504-253W-0*4	210800	210445	210575	*	205253/210371
E56-130/504-253W-0*5	210801	210445	210575	*	205253/210371
E56-130/504-263N-0*4	210796	210445-BF	210574-BF	*	201230C/210371
E56-130/504-263N-0*5	210797	210445-BF	210574-BF	*	201230C/210371
E56-131/512-253W-2*3	210808	210445-BF	210575-BF	*	205253/210503
E56-131/514-253W-2*3	210808	210445-BF	210575-BF	*	205253/210503
E56-131/512-253W-2*4	210809	210445-BF	210575-BF	*	205253/210503
E56-131/514-253W-2*4	210809	210445-BF	210575-BF	*	205253/210503
E56-132-514-263W-2*3	210804	210445-BF	210574-BF	*	201230C/210503
E56-133/514-263N-2*3	210804	210445-BF	210574-BF	*	201230C/210503
E56-132-514-263W-2*4	210805-PG	210445-BF	210574-BF	*	201230C/210503
E56-133/514-263N-2*4	210805-PG	210445-BF	210574-BF	*	201230C/210503
E56-134/504-233W-0*3	210786	210443	210697	*	202799/210370
E56-134/504-233W-0*4	210787	210443	210697	*	202799/210371
E56-134/504-233W-0*5	210788	210443	210697	*	202799/210371
E56-210/505-223N-0*3	210783	210442-BF	210569-BF	*	201152E/201155C
E56-211/503-223N-0*3	210783	210442-BF	210569-BF	*	201152E/201155C
E56-210/505-223N-0*4	210784	210442-BF	210569-BF	*	201152E/201155C
E56-211/503-223N-0*4	210784	210442-BF	210569-BF	*	201152E/201155C
E56-220-503-233W-0*3	210786	210443	210568-PG	*	202766/210370
E56-220-503-233W-0*4	210787	210443	210568-PG	*	202766/210371
E56-220-503-233W-0*5	210788	210443	210568-PG	*	202766/210371
E56-231/503-123N-0*1.5	210934	210442-BF	211290-BF	*	201230C/205525
E56-231/504-123N-0*1.5	210934	210442-BF	211290-BF	*	201230C/205525
E56-242/504-253W-0*3	210799	210959-PG	210996	*	205135
E56-242/504-253W-0*4	210800	210959-PG	210996	*	205135
E56-242/504-253W-0*5	210801	210959-PG	210996	*	205136
E56-242/504-263W-0*4	210796	210959-PG	210997	*	205135
E56-242/504-263W-0*5	210797	210959-PG	210997	*	205136
E56-243/512-253W-2*3	210808	210959-PG	210996	*	205136
E56-243/514-263W-2*3	210808	210959-PG	210996	*	205136
E56-243/512-253W-2*4	210809	210959-PG	210996	*	205136
E56-243/514-263W-2*4	210809	210959-PG	210996	*	205136
E56-243/512-253W-2*5	210810	210959-PG	210996	*	205136
E56-243/514-263W-2*5	210810	210959-PG	210996	*	205136
E56-243/512-263W-2*3	210804	210959-PG	210997	*	205136
E56-243/514-263W-2*3	210804	210959-PG	210997	*	205136
E56-243/512-263W-2*4	210805-PG	210959-PG	210997	*	205136





飞马包缝机针位 (PEGASUS)

MODEL					
机种	NEEDLE PLATE 针板	DIFF FEED DOG 牙齿	MAIN FEED DOG 牙齿	NEEDLE CLAMP 针头	PRESSER FOOT 压脚
E56-243/514-263W-2*4	210805-PG	210959-PG	210997	*	205136
U32-48-3*3	204374	204420	204404	204037A	204456
U32-48-3*4	204375	204420	204404	204037A	204456
U32-48-3*5	204376	204420	204404	204037A	204456
U32-48-3*6	204377	204420	204404	204037A	204456
U32-70-5*3	204358A	204250B	204248B	204430	204433A
U32-70-5*4	204359A	204250B	204248B	204430	204433A
U32-70-5*5	204360A	204250B	204248B	204430	204433A
U32-70-5*6	204361A	204250B	204248B	204430	204433A
U32-72-5*3	204358A	204408	204394	204430	204433A
U32-72-5*4	204359A	204408	204394	204430	204433A
U32-72-5*5	204360A	204408	204394	204430	204433A
U32-72-5*6	204361A	204408	204394	204430	204433A
U32-74-5*5	204380	204415	204248B	204430	204433A
U32-76-5*5	204380	204416	204394	204430	204433A
U32-78-5*5	204380	204422	204406	204430	204458
U52-01-0*2	202616	204730	204729A 204674 (AUX)	*	201152E/201155C
U52-01-0*3	202617	204730	204729A 204674 (AUX)	*	201152E/201155C
U52-01-0*4	202618	204730	204729A 204674 (AUX)	*	201152E/201155C
U52-17-0*4	202546E	204690	204675A 204674 (AUX)	*	201230C/201155C
U52-17S-0*4	202546E	204679	204678A 204674 (AUX)	*	201230C/201155C
U52-12-2*3	205255	204690	204675A 204674 (AUX)	208905	201230C/201396B
U52-12-2*4	202554E	204690	204675A 204674 (AUX)	208905	201230C/201310A
U52-12S-2*3	205255	204691	204678A 204674 (AUX)	208905	201230C/201396B
U52-12S-2*4	202554E	204691	204678A 204674 (AUX)	208905	201230C/201310A
R53-01-0*2	202616	201097C	201094B 202634A (AUX)		201152E/201155C
R53-01-0*3	202617	201097C	201094B 202634A (AUX)		201152E/201155C
R53-01-0*4	202618	201097C	201094B 202634A (AUX)		201152E/201155C
R53-05-2*3	202702	202854A	201094B 202634A (AUX)	208905	201230C/201396B
R53-09-2*3	202702	202854A	201094B 202634A (AUX)	208905	201230C/201396B
R53-15-2*3	202702	202854A	201094B 202634A (AUX)	208905	201230C/201396B
R53-05-2*4	202675	202854A	201094B 202634A (AUX)	208905	201230C/201310A
R53-09-2*4	202675	202854A	201094B 202634A (AUX)	208905	201230C/201310A

飞马包缝机针位 (PEGASUS)

MODEL					
机种	NEEDLE PLATE 针板	DIFF FEED DOG 牙齿	MAIN FEED DOG 牙齿	NEEDLE CLAMP 针头	PRESSER FOOT 压脚
R53-15-2*4	202675	202854A	201094B 202634A (AUX)	208905	201230C/201310A
EX3216-02/223K-3*3	277515R30	277326-16	277323-16	277027-92	277118
EX3216-02/223K-3*4	277513R40	277325-16	277323-16	277027-92	277118
EX3216-02/223K-3*5	277513R50	277325-16	277323-16	277027-92	277118
EX3216-02A/223-3*3	277515R30	277326-16	277323-16	277027-92	211909
EX3216-02A/223-3*4	277513R40	277325-16	277323-16	277027-92	211909
EX3216-02A/223-3*5	277513R50	277325-16	277323-16	277027-92	211910
EX3216-03/233K-3*4	277517R40	277330-16	277327-16	277027-92	277118
EX3216-03/233K-3*5	277517R50	277330-16	277327-16	277027-92	277118
EX3216-03/23K-5*5	277516R50	277329-16	277327-16	277028-92	277119
EX3216-03/23K-5*6	277516R60	277329-16	277327-16	277028-92	277119
EX3216-03/333K-3*4	277517R40	277330-16	277327-16	277027-92	277118
EX3216-03/333K-5*5	2577516R50	277329-16	277327-16	277028-92	277119
EX3244-03/333K-3*2*4	277518R40	277329-16	277327-16	277030-92	277118A
EX3244-03/333K-5*2*4	277519R40	277329-16	277327-16	277031-92	277119A
EX3216-04/435K-5*5	277524T50	277339-25	277337-25	277029-92	277122
EX3216-04/435K-5*6	277524T60	277339-25	277337-25	277029-92	277122
EX3216-42-233K-3*4	277521R40	277336-16	277334-16	277027-92	277120
EX3216-42-233K-3*5	277521R50	277336-16	277334-16	277027-92	277120
EX3216-42-233K-5*5	277520R50	277333-16	277331-16	277028-92	277121
EX3216-42-233K-5*6	277520R60	277333-16	277331-16	277028-92	277121
EX5204-01/223K-0*3	277500P30	277302-16F	277300-16F	179630-92	201230C/210370
EX5204-01/223K-0*4	277500P40	277302-16F	277300-16F	179630-92	201230C/210371
EX5204-01/223K-0*5	277500P50	277302-16F	277300-16F	179630-92	201230C/210371
EX5204-02/233K-0*3	277504R30	277305-16F	277303-16F	179630-92	201230C/210370
EX5204-02/233K-0*4	277504R40	277305-16F	277303-16F	179630-92	201230C/210371
EX5204-02/233K-0*5	277504R50	277305-16F	277303-16F	179630-92	201230C/210371
EX5204-32R2/223LK-0*1.5	277502P15	277302-16F	277315-16F	179630-92	202799/205525
EX5205-12/223K-0*3	277500P30	277302-16F	277300-16F	179630-92	201152E/277115
EX5203-12/223k-0*3	277500P30	277302-16F	277300-16F	179630-92	201152E/277115
EX5205-12/223K-0*4	277500P40	277302-16F	277300-16F	179630-92	201152E/277103
EX5203-12/223k-0*4	277500P40	277302-16F	277300-16F	179630-92	201152E/277103
EX5212-02/333K-2*3	277505R30	277305-16F	277303-16F	277022-92	201230C/210503
EX5214-03/333K-2*3	277505R30	277305-16F	277303-16F	277022-92	201230C/210503
EX5214-03C3/333K-2*3	277505R30	277305-16F	277303-16F	277022-92	201230C/210503
EX5214-M03/333K-2*3	277505R30	277305-16F	277303-16F	277022-92	201230C/210503







飞马包缝机针位 (PEGASUS)

MODEL					
机种	NEEDLE PLATE 针板	DIFF FEED DOG 牙齿	MAIN FEED DOG 牙齿	NEEDLE CLAMP 针头	PRESSER FOOT 压脚
EX5214-MO3C3/333K-2*3	277505R30	277305-16F	277303-16F	277022-92	201230C/210503
EX5212-02/333K-2*4	277505R40	277305-16F	277303-16F	277022-92	20130C/210374
EX5214-03/333K-2*4	277505R40	277305-16F	277303-16F	277022-92	20130C/210374
EX5214-03C3/333K-2*4	277505R40	277305-16F	277303-16F	277022-92	20130C/210374
EX5214-M03/333K-2*4	277505R40	277305-16F	277303-16F	277022-92	20130C/210374
EX5214-MO3C3/333K-2*4	277505R40	277305-16F	277303-16F	277022-92	20130C/210374
EX5212-02/333K-2*5	277505R50	277305-16F	277303-16F	277022-92	20130C/210374
EX5214-03/333K-2*5	277505R50	277305-16F	277303-16F	277022-92	20130C/210374
EX5214-03C3/333K-2*5	277505R50	277305-16F	277303-16F	277022-92	20130C/210374
EX5214-M03/333K-2*5	277505R50	277305-16F	277303-16F	277022-92	20130C/210374
EX5214-01/233K-2*3	277505P30	277305-16F	277303-16F	277022-92	201230C/201396B
EX5214-01/233K-2*4	277505P40	277305-16F	277303-16F	277022-92	201230C/201310A
EX5214-43/332K-2*3	277505R30	277308-16	277306-16	277022-92	277124
EX5214-43/332K-2*4	277505R40	277308-16	277306-16	277022-92	277124
EX5214-43P1/333K-2*3	277505R30	277308-16	277306-16	277022-92	277125
EX5214-43P2/333K-2*3	277505R30	277308-16	277306-16	277022-92	277125
EX5214-43P1/333K-2*4	277505R40	277308-16	277306-16	277022-92	277125
EX5214-43P2/333K-2*4	277505R40	277308-16	277306-16	277022-92	277125
EX5214-53/333K-2*3	277505R30	277305-16F	277303-16F	277022-92	277112/277159
EX5214-53C3-333-2*3	277505R30	277305-16F	277303-16F	277022-92	277112/277159
EX5214-M53/333K-2*3	277505R30	277305-16F	277303-16F	277022-92	277112/277159
EX5214-M53/333K-2*3	277505R30	277305-16F	277303-16F	277022-92	277112/277159
EX5214-53/333K-2*4	277505R40	277305-16F	277303-16F	277022-92	277112/208651
EX5214-53C3-333-2*4	277505R40	277305-16F	277303-16F	277022-92	277112/208651
EX5214-M53/333K-2*4	277505R40	277305-16F	277303-16F	277022-92	277112/208651
EX5214-M53C3/333K-2*4	277505R40	277305-16F	277303-16F	277022-92	277112/208651
EX52*5/333K-2*5	277505R50	277305-16F	277303-16F	277022-92	277112/208652
EX52*5C3-333-2*5	277505R50	277305-16F	277303-16F	277022-92	277112/208652
EX52*5/333K-2*5	277505R50	277305-16F	277303-16F	277022-92	277112/208652
EX52*5C3/333K-2*5	277505R50	277305-16F	277303-16F	277022-92	277112/208652
EX5214-54/433K-2*3	277505R30	277316-16F	277303-16F	277022-92	277112/277159
EX5214-54/433K-2*4	277505R40	277316-16F	277303-16F	277022-92	277112/208651
EX5214-54/433K-2*5	277505R50	277316-16F	277303-16F	277022-92	277112/208651
EX5214-92M2/223K-2*3	277501R30	277302-16F	277300-16F	277022-92	201152E/201396B
EX5214-92M2/223K-2*4	277501R40	277302-16F	277300-16F	277022-92	201152E/201310A

重机包缝机针位 (JUKI)

MODEL						
机种	NEEDLE PLATE 针板	DIFF FEED DOG 牙齿	MAIN FEED DOG 牙齿	CHAIN FEED DOG 牙齿	NEEDLE CLAMP 针头	PRESSER FOOT 压脚
MO-352	B1137-352-00	B1613-352-000	B1614-352-000	*	*	B1510-352-0A0 (B1526-352-0A0)
MO-354	B1137-354-000	B1613-352-000	B1614-352-000	*	B1415-354-000A	B1510-354-0A0
MO-357A 1.6MM	B1136-357-A00	B1614-357-A00	B1613-357-A00	*	B1415-357-AA0	B1510-357-AA0
MO-357B 2.0MM	B1136-357-B00	B1614-357-A00	B1613-357-A00	*	B1415-357-BA0	B1510-357-BA0
MO-357C 2.4MM	B1136-357-C00	B1614-357-A00	B1613-357-A00	*	B1510-357-CA0	B1510-357-CA0
MO-357D 3.2MM	B1136-357-D00	B1614-357-A00	B1613-357-A00	*	B1510-357-DA0	B1510-357-DA0
MO-804-0D4 0*3.2MM	R420-E00-C00	B1657-805-000A	B1656-805-000	B1658-805-000	B1435-804-000	B1507-804-0A0
MO-812-DD6 3.2*3.2MM	R4308-E0D-E00	B1657-812-D0A	B1656-812-D0C	B1658-812-00A	B1420-712-D00	B1507-812-DAC
MO-812-DF6 3.2*4.8MM	R4308-E0F-E00	B1657-812-D0A	B1656-812-D0C	B1658-812-00A	B1420-712-D00	B1507-812-DAC
MO-814-BD4 2.0*3.2MM	R4205-E0D-E00	B1657-804-00C	B1656-804-000	B1658-804-000	B1420-714-B00	B1507-814-0A0
MO-814-BD0 2.0*3.2MM	B1134-814-B0AA	B1657-804-00C	B1656-804-000	B1658-804-000	B1420-714-B00	B1507-814-0A0
MO-814-BD6 2.0*3.2MM	R4305-E0D-E00	B1657-814-B0A	B1656-814-B0A	B1658-804-000	B1420-714-B00	B1507-814-0AD
MO-814-B00-S012 2.0*3.2MM	B1134-814-B0AA	B1657-814-B0C	B1656-814-B0B	B1658-804-000	B1420-714-B00	B1507-814-0A0
MO-816-DD4 3.2*3.2MM	R4508-E0D-C00	B1657-816-000	B1656-816-000	B1658-804-000	B1420-716-D00	B1507-816-0A0
MO-816-DD6-3.2*3.2MM MO-1016-DD6-3.2*3.2MM	R4608-E0D-F00	B1657-816-D0G	B1656-816-000	B1658-804-000	B1420-716-D00	B1507-816-0A0
MO-816-DF6-3.2*4.8MM MO-1016-DF6-3.2*4.8MM	R4608-E0F-G00	B1657-816-F0K	B1656-816-D0J	B1658-804-000	B1420-716-D00	B1507-816-DAB
MO-816-FF6-4.8*4.8MM MO-1016-FF6-4.8*4.8MM	R4612-E0F-G00A	B1657-816-F0K	B1656-816-F0H	B1658-804-000	B1420-716-F00	B1507-816-FAD
MO-1012-DF6 3.2*3.2MM	R4308-E0F-E0A	117-90706	B1656-812-D0C	B1658-812-00A	B1420-712-D00	117-90557
MO-2504-0A4-150 1.6MM	R4200-H0A-C00	B1657-804-00T	118-82107	118-87007	118-69005	118-76059
MO-2504-0A4-150-FG 1.6MM						118-76067
MO-2504-0D4 3.2MM	R4200-HOD-DA0	B1657-804-00T	118-82107	118-87106	118-69005	118-76158
MO-2504-0D4-FG 3.2MM	R4200-HOD-DA0	B1657-804-00T	118-82107	118-87106	118-69005	118-76166
MO-2504-0D4-200 3.2MM	R4200-HOD-D00	B1657-804-00T	118-82107	118-87106	118-69005	118-81455
MO-2504-0D4-200-FG 3.2MM	R4200-HOD-D00	B1657-804-00T	118-82107	118-87106	118-69005	118-81471

重机包缝机针位 (JUKI)

MODEL						
机种	NEEDLE PLATE 针板	DIFF FEED DOG 牙齿	MAIN FEED DOG 牙齿	CHAIN FEED DOG 牙齿	NEEDLE CLAMP 针头	PRESSER FOOT 压脚
MO-2504-0D4-300 3.2MM	R4200-HOD-D00	B1657-804-00T	118-82107	118-87106	118-69005	118-76158
MO-2504-0D4-300-FG 3.2MM	R4200-HOD-D00	B1657-804-00T	118-82107	118-87106	118-69005	118-76166
MO-2504-0E4-300 4.0MM	R4200-HOE-D00	B1657-804-00T	118-82107	118-87106	118-69005	118-76158
MO-2504-0E4-300-FG 4.0MM	R4200-HOE-D00	B1657-804-00T	118-82107	118-87106	118-69005	118-76166
MO-2504-0F4-300 4.8MM	R4200-HOF-D00	B1657-804-00T	118-82107	118-87106	118-69005	118-76257
MO-2504-0F4-300-FG 4.8MM	R4200-HOF-D00	B1657-804-00T	118-82107	118-87106	118-69005	118-76265
MO-2504-0D6-300 3.2MM	R4300-HOD-E00	118-85100	118-82206	118-87106	118-69005	118-76356
MO-2504-0D6-300-FG 3.2MM	R4300-HOD-E00	118-85100	118-82206	118-87106	118-69005	118-76364
MO-2504-0D6-320 3.2MM	R4300-HOD-DOA	B1657-814-B0L	118-83402	118-87106	118-69005	118-78857
MO-2504-0D6-320-FG 3.2MM	R4300-HOD-DOA	B1657-814-B0L	118-83402	118-87106	118-69005	118-78865
MO-2504-0F6-500 4.8MM	R4300-HOF-E00	118-85100	118-82206	118-87106	118-69005	118-76455
MO-2504-0F6-500-FG 4.8MM	R4300-HOF-E00	118-85100	118-82206	118-87106	118-69005	118-76463
MO-2505-0D4-210 3.2MM	R4200-HOD-D00	B1657-804-00T	118-82107	118-87106	118-69005	118-78550
MO-2505-0D4-210-FG 3.2MM	R4200-HOD-D00	B1657-804-00T	118-82107	118-87106	118-69005	118-78568
MO-2512-DD6-500 3.2*3.2MM	R4308-HOD-E00	117-90706	118-82503	119-87005	118-69955	118-77156
MO-2512-DD6-500-FG 3.2*3.2MM	R4308-HOD-E00	117-90706	118-82503	119-87005	118-69955	118-77164
MO-2512-DF6-500 3.2-4.8MM	R4308-HOF-E00	117-90706	118-82503	119-87005	118-69955	118-77156
MO-2512-DF6-50-FG 3.2-4.8MM	R4308-HOF-E00	117-90706	118-82503	119-87005	118-69955	118-77164
MO-2514-BD4 2.0*3.2MM	R4205-HOD-EA0	B1657-814-B0E	115-97101	118-87106	118-69658	118-76851
MO-2514-BD4-FG 2.0*3.2MM	R4205-HOD-EA0	B1657-814-B0E	115-97101	118-87106	118-69658	118-76869
MO-2514-BD4-200 2.0*3.2MM	R4205-HOD-EA0	B1657-814-B0E	115-97101	118-87106	118-69658	118-81554
MO-2514-BD4-200-FG 2.0*3.2MM	R4205-HOD-EA0	B1657-814-B0E	115-97101	118-87106	118-69658	118-81570

### 重机包缝机针位 (JUKI)

MODEL						
机种	针板	牙齿	牙齿	牙齿	针头	压脚
MO-2514-BD4-300 2.0*3.2MM	R4205-HOD-EA0	B1657-814-B0E	115-97101	118-87106	118-69658	118-76851
MO-2514-BD4-300-FG 2.0*3.2MM	R4205-HOD-EA0	B1657-814-B0E	115-97101	118-87106	118-69658	118-76869
MO-2514-BE4-300 2.0*4.0MM	R4205-HOE-E00	B1657-814-B0E	115-97101	118-87106	118-69658	118-76851
MO-2514-BE4-300-FG 2.0*4.0MM	R4205-HOE-E00	B1657-814-B0E	115-97101	118-87106	118-69658	118-76869
MO-2514-BD6-300 2.0*3.2MM	R4305-HOD-E00	118-86504	118-82404	118-87106	118-69658	118-76851
MO-2514-BD6-300-FG 2.0*3.2MM	R4305-HOD-E00	118-86504	118-82404	118-87106	118-69658	118-76869
MO-2514-BD6-320 2.0*3.2MM	R4305-HOD-E0A	B1657-814-B0L	118-83402	118-87106	118-69658	118-79350
MO-2514-BD6-320-FG 2.0*3.2	R4305-HOD-E0A	B1657-814-B0L	118-83402	118-87106	118-69658	118-79368
MO-2514-BD6-3B0 2.0*3.0	R4305-HOD-E0A	B1657-814-B0L	118-83402	118-87106	118-69658	118-79053
MO-2514-BD6-3B0-FG 2.0*3.0MM	R4305-HOD-E0A	B1657-814-B0L	118-83402	118-87106	118-69658	118-79061
MO-2514-BD6-340 2.0*3.2MM	R4305-HOD-E00	118-86504	118-82404	118-87106	118-69658	118-79251
MO-2514-BD6-340-FG 2.0*3.2MM	R4305-HOD-E00	118-86504	118-82404	118-87106	118-69658	118-79269
MO-2514-BD6-347 2.0*3.2MM	R4305-HOD-E00	118-86504	118-82404	118-87106	118-69658	118-79251
MO-2514-BD6-347-FG 2.0*3.2MM	R4305-HOD-E00	118-86504	118-82404	118-87106	118-69658	118-79269
MO-2516-BD4-300 2.0*3.2MM	R4505-HOD-D00	118-85209	118-82602	118-87304	118-70151	118-77354
MO-2516-BD4-300FG 2.0*3.2MM	R4505-HOD-D00	118-85209	118-82602	118-87304	118-70151	118-77362
MO-2516-DD4-300 3.2*3.2MM	R4508-HOD-D00	118-85209	118-82800	118-87403	118-70359	118-77552
MO-2516-DD4-300-FG 3.2*3.2MM	R4508-HOD-D00	118-85209	118-82800	118-87403	118-70359	118-77578
MO-2516-DF4-300 3.2*4.8MM	R4508-HOF-DOO	118-85209	118-82800	118-87403	118-70359	118-77552
MO-2516-DF4-300-FG 3.2*4.8MM	R4508-HOF-DOO	118-85209	118-82800	118-87403	118-70359	118-77578
MO-2516-DD6-320 3.2*3.2MM	R4608-HOD-F00	118-85803	118-83907	118-87403	118-70359	118-79657
MO-2516-DD6-320-FG 3.2*3.2MM	R4608-HOD-F00	118-85803	118-83907	118-87403	118-70359	118-79665

### 重机包缝机针位 (JUKI)

MODEL						
机种	针板	牙齿	牙齿	牙齿	针头	压脚
MO-2516-DD6-550 3.2*3.2MM	R4608-HOD-F00	118-85308	118-82909	118-87304	118-70359	118-77552
MO-2516-DD6-550-FG 3.2*3.2MM	R4608-HOD-F00	118-85308	118-82909	118-87304	118-70359	118-77578
MO-2516-DF6-500 3.2*4.8MM	R4608-HOF-G00	118-85407	118-84400	118-87403	118-70359	118-77651
MO-2516-DF6-500-FG 3.2*4.8MM	R4608-HOF-G00	118-85407	118-84400	118-87403	118-70359	118-77669
MO-2516-FF6-100 4.8*4.8MM	R4612-HOF-B00	118-86009	118-84004	118-87403	118-70458	118-80556
MO-2516-FF6-100-FG 4.8*4.8MM	R4612-HOF-B00	118-86009	118-84004	118-87403	118-70458	118-80564
MO-2516-FF6-320 4.8*4.8MM	R4612-HOF-B00	118-85902	118-84103	118-87403	118-70458	118-80457
MO-2516-FF6-320-FG 4.8*4.8MM	R4612-HOF-B00	118-85902	118-84103	118-87403	118-70458	118-820465
MO2516-FF6-500 4.8*4.8MM	R4612-HOF-G00	118-85407	118-83006	118-87304	118-70458	118-77750
MO2516-FF6-500-FG 4.8*4.8MM	R4612-HOF-G00	118-85407	118-83006	118-87304	118-70458	118-77768
MO-2543-DBD6-300 3.2*2.0*3.2MM	R4608-HOD-E01	118-86009	118-82305	118-87403	118-70755	118-77958
MO-2543-DBD6-300-FG 3.2*2.0*3.2MM	R4608-HOD-E01	118-86009	118-82305	118-87403	118-70755	118-77966
MO-2543-FBD6-300 4.8*2.0*3.2MM	R4612-HOD-E01	118-86009	118-84004	118-87403	118-70854	118-78055
MO-2543-FBD6-300-FG 4.8*2.0*3.2MM	R4612-HOD-E01	118-86009	118-84004	118-87403	118-70854	118-78063
MO-2554-0D4-30D 3.2MM	R4200-HOD-D00	B1657-804-00T	118-82107	118-87106	118-69005	118-78550
MO-2554-0D4-30D-FG 3.2MM	R4200-HOD-D00	B1657-804-00T	118-82107	118-87106	118-69005	118-78568
MO-2566-DD4-30D 3.2*3.2MM	R4508-HOD-DOE	118-85209	118-82800	118-87403	118-70359	118-77552
MO-2566-DD4-30D-FG 3.2*3.2MM	R4508-HOD-DOE	118-85209	118-82800	118-87403	118-70359	118-77578
MO-2566-FF6-50D-FG 4.8*4.8MM	R4612-HOF-G00	119-81404	119-81305	118-87403	118-70458	118-80762
MO-3304-0E 0*4.0MM	E4200-LOE-E00	124-78004	124-76008	124-80000	124-65001	124-66508
MO-3304-0E4-FG 0*4.0MM	E4200-LOE-E00	124-78004	124-76008	124-80000	124-65001	124-66508
MO-3314-BE6 2.0*4.0MM	R4305-LOE-E00	124-78103	124-76107	124-80109	124-65407	124-66553

### 重机包缝机针位 (JUKI)

MODEL						
机种	NEEDLE PLATE 针板	DIFF FEED DOG 牙齿	MAIN FEED DOG 牙齿	CHAIN FEED DOG 牙齿	NEEDLE CLAMP 针头	PRESSER FOOT 压脚
MO-3314-BE6-FG 2.0*4.0MM	R4305-LOE-E00	124-78103	124-76107	124-80109	124-65407	124-66553
MO-3316-DE4 3.2*4.0MM	R4508-LOE-G00	124-78202	124-76206	124-80208	124-65100	124-70050
MO-3316-DE4-FG 3.2*4.0MM	R4508-LOE-G00	124-78202	124-76206	124-80208	124-65100	124-70050
ME-3604-0E-0*4MM ME-3904-0E-0*4MM	R4200-JOE-D00	1657-804-OOT	118-82107	118-87106	121-48607	118-76158
MO-3604-0E4-FG-0*4MM MO-3904-0E4-FG-0*4MM	R4200-JOE-D00	1657-804-OOT	118-82107	118-87106	121-48607	118-76166
MO-3614-BE6-2.0*4.0MM MO-3914-BE6-2.0*4.0MM	R4305-JOE-E00	119-49906	119-49807	118-87106	121-48706	121-52450
MO-3614-BE6-FG-2.0*4.0MM MO-3914-BE6-FG-2.0*4.0MM	R4305-JOE-E00	119-49906	119-49807	118-87106	121-48706	121-52468
MO-3616-DE4-3.2*4.0MM MO-3916-DE4-3.2*4.0MM	R4508-JOE-D00	121-72805	118-82800	118-87403	121-49803	121-53755
MO-3616-DE4-FG-3.2*4.0MM MO-3916-DE4-FG-3.2*4.0MM	R4508-JOE-D00	121-72805	118-82800	118-87403	121-49803	121-53763
MO-3616-FF6-4.8*4.8MM MO-3916-FF6-4.8*4.8MM	R4612-JOF-D00	121-73308	118-84004	118-87403	121-50306	124-54258
MO-3616-FF6-FG-4.8*4.8MM MO-3916-FF6-FG-4.8*4.8MM	R4612-JOF-D00	121-73308	118-84004	118-87403	121-50306	121-54266

### 兄弟包缝机针位 (BROTHER)





MODEL	SIZE					
机种	尺寸	NEEDLE PLATE 针板	DIFF FEED DOG 牙齿	MAIN FEED DOG 牙齿	CHAIN FEED DOG 牙齿	PRESSER FOOT 压脚
EF4-B511-001-3	0*3	146730-0-01	146748-0-01 (S09349-1-01)	146744-0-01 (S09348-1-01)	146577-0-01 (S13428-0-01)	146884-0-01 (156558-1-01)
EF4-B511-001-4	0*4	146731-0-01				(156562-1-01)
EF4-B511-001-5	0*5	146732-0-01				
EF4-B511-001-6	0*6	146733-0-01	146750-0-01	146745-0-01	146578-0-01 (S13429-0-01)	146898-0-01 (S03828-0-01)
EF4-B511-002-5	0*5	146734-0-01				(154974-0-01)
EF4-B511-002-6	0*6	146735-0-01				
EF4-B511-002-7	0*7	146736-0-01				
EF4-B511-003-3	0*3	146730-0-01	146748-0-01 (S09349-1-01)	146744-0-01 (S0948-1-01)	146577-0-01 (S13428-0-01)	146890-0-01
EF4-B511-003-4	0*4	146731-0-01				
EF4-B511-003-5	0*5	146732-0-01				
EF4-B511-004-3	0*3	146730-0-01				
EF4-B511-004-4	0*4	146731-0-01				
EF4-B511-005-4	0*4	146731-0-01				
EF4-B511-005-5	0*5	146732-0-01				146893-0-01 (154970-0-01)
EF4-B511-006-4	0*4	146731-0-01	148311-0-01 (154976-1-01)			
EF4-B511-006-5	0*5	146732-0-01				
EF4-B511-007-4	0*4	148314-0-01				
EF4-B511-008-5	0*5	146737-0-01	146751-0-01 (S13417-0-01)	146746-0-01 (S13188-0-01)	146578-0-01 (S13429-0-01)	144811-0-01 (154971-0-01) (S07199-0-01)
EF4-B511-009-5	0*5			147828-0-01 (S13189-0-01)	147832-0-01 (S13431-0-01)	147433-0-01 (154975-0-01) (S07200-0-01)
EF4-B511-010-3	0*3	146730-0-01	146748-0-01 (S09349-1-01)	146744-0-01 (S09348-1-01)	146577-0-01 (S13428-0-01)	146895-0-01 (156560-0-01)
EF4-B511-010-4	0*4	146731-0-01				
EF4-B511-010-5	0*5	146732-0-01				
EF4-B511-011-5	0*5	146734-0-01	146750-0-01	146745-0-01	146578-0-01 (S13429-0-01)	
EF4-B511-011-6	0*6	146735-0-01				
EF4-B511-012-3	0*3	147449-0-01	146748-0-01 (S09349-1-01)	146744-0-01 (S09348-1-01)	146577-0-01 (S13428-0-01)	146884-0-01
EF4-B511-013-4	0*4	146731-0-01				146890-0-01
EF4-B511-017-3	0*3	146730-0-01				
EF4-B511-017-4	0*4	146731-0-01				156558-1-01
EF4-B511-017-5	0*5	146732-0-01				

兄弟包缝机针位 (BROTHER)





MODEL	SIZE									
机种	尺寸	NEEDLE PLATE 针板	DIFF FEED DOG 牙齿	MAIN FEED DOG 牙齿	CHAIN FEED DOG 牙齿	NEEDLE CLAMP 针头	PRESSER FOOT 压脚			
EF4-B531-022-5	2.2*5	146781-0-01 (S01711-0-01)	156036-0-01 (S09350-1-01)	146744-0-01 (S09348-1-01)	1146577-0-01 (S13428-0-01)	146773-0-01	146902-0-01 (156565-0-01)			
EF4-B531-023-5	2.2*5					146773-0-01	146902-0-01 (156565-0-01)			
EF4-B531-022-6	2.2*6	146782-0-01 (S01713-0-01)	156036-0-01 (S09350-1-01)					146773-0-01	146902-0-01 (156565-0-01)	
EF4-B531-023-6	2.2*6					146775-0-01	146965-0-01 (154987-2-01)			
EF4-B531-024-6	3*6	148031-0-01	146749-0-01 (S13416-0-01)	146745-0-01	146578-0-01 (S13429-0-01)	146773-0-01	147952-0-01 (154989-0-01)			
EF4-B531-025-6	3*6						147904-0-01 (154985-0-01)			
EF4-B531-027-5	2.2*5	146781-0-01 (S01711-0-01)	146750-0-01 (156131-0-01)	146745-0-01	146578-0-01 (S13429-0-01)	146773-0-01	147904-0-01 (154985-0-01)			
EF4-B531-028-5	2.2*5								147904-0-01 (154985-0-01)	
EF4-B531-027-6	2.2*6	146782-0-01 (S01713-0-01)								147904-0-01 (154985-0-01)
EF4-B531-028-6	2.2*6					146775-0-01	146965-0-01 (154987-2-01)			
EF4-B531-027-7	2.2*7	146783-0-01 (S01715-0-01)					146965-0-01 (154987-2-01)			
EF4-B531-028-7	2.2*7						146965-0-01 (154987-2-01)			
EF4-B531-031-7	3*7	146785-0-01	146791-0-01	146790-0-01	146577-0-01 (S13428-0-01)	146775-0-01	144815-0-01 (154983-0-01)			
EF4-B531-032-7	3*7						147439-0-01 (154988-0-01)			
EF4-B531-033-5	2.2*5	146786-0-01 (S01717-0-01)	146751-0-01 (S13417-0-01)	146746-0-01 (156332-0-01) (S13192-0-01)	146578-0-01 (S13429-0-01)	146773-0-01	147439-0-01 (154988-0-01)			
EF4-B531-034-5	2.2*5						147439-0-01 (154988-0-01)			
EF4-B531-037-5	*	146786-0-01 (S01717-0-01)	146751-0-01	156338-0-01 (S13189-0-01)	147832-0-01 (S13431-0-01)			147439-0-01 (154988-0-01)		
EF4-B531-041-5	2.2*5	146781-0-01 (S01711-0-01)	146749-0-01 (156036-0-01) (S09350-1-01)	146744-0-01 (S093481-0-01)	146577-0-01 (S13428-0-01)	146773-0-01	147439-0-01 (154988-0-01)			
EF4-B531-045-5	2.2*5	146781-0-01 (S01711-0-01)	146750-0-01 (156131-1-01)	146745-0-01	146578-0-01 (S13429-0-01)	146773-0-01	146906-0-01 (156566-0-01)			
EF4-B531-045-6	2.2*6	146782-0-01 (S01713-0-01)								146906-0-01 (156566-0-01)
EF4-B531-045-7	2.2*7	146783-0-01 (S01715-0-01)								
MA4-B551-061-3	2*3	146498-0-01	146572-0-01	146567-0-01	146577-0-01 (S13428-0-01)	146489-0-01	142250-0-01			
MA4-B551-062-3	2*3									
MA4-B551-063-3	3*3	146501-0-01	146572-0-01	146567-0-01	146577-0-01 (S13428-0-01)	146489-0-01	146871-1-01			
MA4-B551-064-3	3*6									
MA4-B551-063-4	3*4	146502-0-01								
MA4-B551-064-4	3*7	146502-0-01								
MA4-B551-063-5	3*5	146503-0-01								
MA4-B551-064-5	3*8	146503-0-01								
MA4-B551-065-5	5*5	146504-0-01								
MA4-B551-066-5	5*5	146504-0-01								
MA4-B551-061-3	2*3	146498-0-01	146572-0-01	146567-0-01	146577-0-01 (S13428-0-01)	146489-0-01	142250-0-01			
MA4-B551-062-3	2*3									
MA4-B551-063-3	3*3	146501-0-01	146572-0-01	146567-0-01	146577-0-01 (S13428-0-01)	146489-0-01	146871-1-01			
MA4-B551-064-3	3*6									
MA4-B551-063-4	3*4	146502-0-01								
MA4-B551-064-4	3*7	146502-0-01								
MA4-B551-063-5	3*5	146503-0-01								
MA4-B551-064-5	3*8	146503-0-01								
MA4-B551-065-5	5*5	146504-0-01								
MA4-B551-066-5	5*5	146504-0-01								
MA4-B551-061-3	2*3	146498-0-01	146572-0-01	146567-0-01	146577-0-01 (S13428-0-01)	146489-0-01	142250-0-01			
MA4-B551-062-3	2*3									
MA4-B551-063-3	3*3	146501-0-01	146572-0-01	146567-0-01	146577-0-01 (S13428-0-01)	146489-0-01	146871-1-01			
MA4-B551-064-3	3*6									
MA4-B551-063-4	3*4	146502-0-01								
MA4-B551-064-4	3*7	146502-0-01								
MA4-B551-063-5	3*5	146503-0-01								
MA4-B551-064-5	3*8	146503-0-01								
MA4-B551-065-5	5*5	146504-0-01								
MA4-B551-066-5	5*5	146504-0-01								

MODEL	SIZE						
机种	尺寸	NEEDLE PLATE 针板	DIFF FEED DOG 牙齿	MAIN FEED DOG 牙齿	CHAIN FEED DOG 牙齿	NEEDLE CLAMP 针头	PRESSER FOOT 压脚
MA4-B551-069-5	3*5	146508-0-01 (S01773-0-01)	146575-0-01	146570-0-01 (S01777-1-01)	146578-0-01 (S13429-0-01)	146489-0-01	144775-0-01
MA4-B551-071-5	5*5	148398-0-01 (S01774-0-01)	146576-0-01	146571-0-01 (S01778-0-01)	146578-0-01 (S13429-0-01)	146491-0-01	146881-0-01
MA4-B551-071-6	5*6	146509-0-01 (S01775-0-01)	146576-0-01	146571-0-01 (S01778-0-01)	146578-0-01 (S13429-0-01)	146491-0-01	146881-0-01
MA4-B551-87-5	5*5	147783-0-01	146574-0-01	146569-0-01	146577-0-01 (S13428-0-01)	146491-0-01	148013-0-01
MA4-B551-92-5	5*5	147783-0-01	146574-0-01	146569-0-01		146491-0-01	148013-0-01
MA4-B551-87-6	5*6	146510-0-01	146574-0-01	146569-0-01		146491-0-01	148013-0-01
MA4-B551-92-6	5*6	146510-0-01	146574-0-01	146569-0-01		146491-0-01	148013-0-01
MA4-B551-93-6	5*6	146510-0-01	146574-0-01	146569-0-01		146491-0-01	148013-0-01
MA4-B551-87-5S	5*5	159769-0-01	146574-0-01	146569-0-01		146491-0-01	148013-0-01
MA4-B551-92-5S	5*5	159769-0-01	146574-0-01	146569-0-01		146491-0-01	148013-0-01
MA4-B551-87-6S	5*6	159770-0-01	146574-0-01	146569-0-01		146491-0-01	148013-0-01
MA4-B551-92-6S	5*6	159770-0-01	146574-0-01	146569-0-01		146491-0-01	148013-0-01
MA4-B551-93-6S	5*6	159770-0-01	146574-0-01	146569-0-01		146491-0-01	148013-0-01
MA4-B661-063-3	3*3	146501-0-01	146572-0-01	146567-0-01	146577-0-01	154916-0-01	156062-0-01
MA4-B661-064-3	3*6	146501-0-01	146572-0-01	146567-0-01	146577-0-01	154916-0-01	156062-0-01
MA4-B661-063-4	3*4	146502-0-01	146572-0-01	146567-0-01	146577-0-01	154916-0-01	156062-0-01
MA4-B661-064-4	3*7	146502-0-01	146572-0-01	146567-0-01	146577-0-01	154916-0-01	156062-0-01
MA4-B661-063-5	3*5	146503-0-01	146572-0-01	146567-0-01	146577-0-01	154916-0-01	156062-0-01
MA4-B661-064-5	3*8	146503-0-01	146572-0-01	146567-0-01	146577-0-01	154916-0-01	156062-0-01
MA4-B661-065-5	5*5	146504-0-01	146573-0-01	146568-0-01	146577-0-01	154918-0-01	156066-0-01
MA4-B661-066-5	5*5	146504-0-01	146573-0-01	146568-0-01	146577-0-01	154918-0-01	156066-0-01
MA4-B661-069-5	3*5	146508-0-01 (S01773-0-01)	146575-0-01	146570-0-01 (S01777-1-01)	146578-0-01 (S13429-0-01)	154916-0-01	155111-0-01
MA4-B661-071-5	5*5	148398-0-01 (S01774-0-01)	146576-0-01	146571-0-01 (S01778-0-01)	146578-0-01 (S13429-0-01)	154918-0-01	115112-0-01
MA4-B661-071-6	5*6	146509-0-01 (S01775-0-01)	146576-0-01	146571-0-01 (S01778-0-01)	146578-0-01 (S13429-0-01)	154918-0-01	115112-0-01
MA4-B661-083-5	*	146504-0-01	146573-0-01	146568-0-01	146577-0-01 (S13428-0-01)	154918-0-01	156197-0-01
MA4-B661-087-5	5*5	147783-0-01	146574-0-01	146569-0-01		154918-0-01	156066-0-01
MA4-B661-092-5	5*5	147783-0-01	146574-0-01	146569-0-01		154918-0-01	156066-0-01
MA4-B661-087-6	5*6	146510-0-01	146574-0-01	146569-0-01		154918-0-01	156066-0-01
MA4-B661-092-6	5*6	146510-0-01	146574-0-01	146569-0-01		154918-0-01	156066-0-01
MA4-B661-093-6	5*6	146510-0-01	146574-0-01	146569-0-01		154918-0-01	156066-0-01
MA4-B661-087-5S	5*5	159769-0-01	146574-0-01	146569-0-01		154918-0-01	155118-0-01
MA4-B661-092-5S	5*5	159769-0-01	146574-0-01	146569-0-01		154918-0-01	155118-0-01
MA4-B661-087-6S	5*6	159770-0-01	146574-0-01	146569-0-01		154918-0-01	155118-0-01
MA4-B661-092-6S	5*6	159770-0-01	146574-0-01	146569-0-01		154918-0-01	155118-0-01
MA4-B661-093-6S	5*6	159770-0-01	146574-0-01	146569-0-01	154918-0-01	155118-0-01	

### 兄弟包缝机针位 (BROTHER)





MODEL	SIZE				
		NEEDLE PLATE	DIFF FEED DOG	MAIN FEED DOG	PRESSER FOOT
		针板	牙齿	牙齿	压脚
机种	尺寸				
EF4-N11-01-3	0*3	S33023-0-01	S33025-0-01	S19199-0-01	S19255-0-01
EF4-N11-01-4	0*4	S19145-0-01	S19236-0-01	S19199-0-01	S19260-0-01
EF4-N11-01-5	0*5	S19146-0-01	S19236-0-01	S19199-0-01	S19260-0-01
EF4-N11-01-6	0*6	S25185-0-01	S19236-0-01	S19199-0-01	S25535-0-01
EF4-N11-01-3B	0*3	S33024-0-01	S33027-0-01	S19212-0-01	S20879-0-01
EF4-N11-01-4B	0*4	S19154-0-01	S19240-0-01	S19212-0-01	S19260-0-01
EF4-N11-01-5B	0*5	S19155-0-01	S19240-0-01	S19212-0-01	S19260-0-01
EF4-N11-01-6B	0*6	S19161-0-01	S19240-0-01	S19212-0-01	S19264-0-01
EF4-N11-01-3C	0*3	S33024-0-01	S33027-0-01	S19212-0-01	S29947-0-01
EF4-N11-01-4C	0*4	S19154-0-01	S19240-0-01	S19212-0-01	S29948-0-01
EF4-N11-01-5C	0*5	S19155-0-01	S19240-0-01	S19212-0-01	S29948-0-01
EF4-N11-01-6C	0*6	S19161-0-01	S19240-0-01	S19212-0-01	S29949-0-01
EF4-N11-02-5	0*5	S19147-0-01	S19237-1-01	S19202-0-01	S19262-0-01
EF4-N11-02-6	0*6	S19148-0-01	S19237-1-01	S19202-0-01	S19264-0-01
EF4-N11-02-7	0*7	S25186-0-01	S19237-1-01	S19202-0-01	S19264-0-01
EF4-N11-08*5	0*5	S19146-0-01	S19243-0-01	S19500-0-01	S19291-0-01
EF4-N11-09-5	0*5	S19146-0-01	S19243-0-01	S19500-0-01	S25538-0-01
EF4-N11-10-4	0*4	S19154-0-01	S19240-0-01	S19212-0-01	S19273-0-01
EF4-N11-10-5	0*5	S19155-0-01	S19240-0-01	S19212-0-01	S19273-0-01



### 兄弟包缝机针位 (BROTHER)







MODEL	SIZE					
		NEEDLE PLATE	DIFF FEED DOG	MAIN FEED DOG	NEEDLE CLAMP	PRESSER FOOT
		针板	牙齿	牙齿	针头	压脚
机种	尺寸					
EF4-N11-11-5	0*5	S19147-0-01	S19237-1-01	S19202-0-01	*	S19273-0-01
EF4-N11-11-6	0*6	S19148-0-01	S19237-1-01	S19202-0-01	*	S19273-0-01
EF4-N11-17-4	0*4	S19154-0-01	S19240-0-01	S19212-0-01	*	S20879-0-01
EF4-N11-17-5	0*5	S19155-0-01	S19240-0-01	S19212-0-01	*	S19262-0-01
EF4-N21-22-4	2.2*4	S25190-0-01	S19240-0-01	S19217-0-01	S20398-0-01	S25543-0-01
EF4-N21-22-5	2.2*5	S19162-0-01	S19240-0-01	S19217-0-01	S20398-0-01	S19280-0-01
EF4-N21-22-6	2.2*6	S19163-0-01	S19240-0-01	S19217-0-01	S20398-0-01	S19282-0-01
EF4-N21-22-7	2.2*7	S25191-0-01	S19240-0-01	S19217-0-01	S20398-0-01	S19282-0-01
EF4-N21-23*5	2.2*5	S19162-0-01	S19236-0-01	S19199-0-01	S20398-0-01	S19280-0-01
EF4-N21-23*6	2.2*6	S19163-0-01	S19236-0-01	S19199-0-01	S20398-0-01	S19282-0-01
EF4-N21-23*7	2.2*7	S25191-0-01	S19236-0-01	S19199-0-01	S20398-0-01	S19282-0-01
EF-N21-22-4B	2.2*4	S25527-0-01	S19240-0-01	S19212-0-01	S20398-0-01	S25543-0-01
EF-N21-22-5B	2.2*5	S19169-0-01	S19240-0-01	S19212-0-01	S20398-0-01	S19280-0-01
EF-N21-22-6B	2.2*6	S19170-0-01	S19240-0-01	S19212-0-01	S20398-0-01	S19282-0-01
EF-N21-22-7B	2.2*7	S25193-0-01	S19240-0-01	S19212-0-01	S20398-0-01	S19282-0-01
EF-N21-22-4C	2.2*4	S25527-0-01	S19240-0-01	S19212-0-01	S20398-0-01	S29952-0-01
EF-N21-22-5C	2.2*5	S19169-0-01	S19240-0-01	S19212-0-01	S20398-0-01	S29950-0-01
EF-N21-22-6C	2.2*6	S19170-0-01	S19240-0-01	S19212-0-01	S20398-0-01	S29951-0-01
EF-N21-22-7C	2.2*7	S25193-0-01	S19240-0-01	S19212-0-01	S20398-0-01	S29951-0-01
EF4-N21-24-5	3*5	S19164-0-01	S192420-01	S19199-0-01	S20402-0-01	S19284-0-01
EF4-N21-24-6	3*6	S19165-0-01	S192420-01	S19199-0-01	S20402-0-01	S19285-0-01
EF4-N21-24-7	3*7	S19168-0-01	S192420-01	S19199-0-01	S20402-0-01	S29869-0-01
EF4-N21-27-5	2.2*5	S19166-0-01	S19237-1-01	S19202-0-01	S20398-0-01	S19287-2-01
EF4-N21-27-6	2.2*6	S19167-0-01	S19237-1-01	S19202-0-01	S20398-0-01	S19288-2-01
EF4-N21-27-7	2.2*7	S25192-0-01	S19237-1-01	S19202-0-01	S20398-0-01	S19288-2-01
EF4-N21-33-5	2.2*5	S19162-0-01	S19243-0-01	S19500-0-01	S20398-0-01	S19291-0-01
EF4-N21-37-5	2.2*5	S19162-0-01	S19243-0-01	S19500-0-01	S20398-0-01	S25538-0-01
EF4-N21-41-5	2.2*5	S19169-0-01	S19240-0-01	S19212-0-01	S20398-0-01	S19293-0-01
EF4-N21-41-6	2.2*6	S19170-0-01	S19240-0-01	S19212-0-01	S20398-0-01	S25546-0-01
EF4-N21-45-5	2.2*5	S19169-0-01	S19244-1-01	S19219-0-01	S20398-0-01	S19297-0-01
EF4-N21-45-6	2.2*6	S19170-0-01	S19244-1-01	S19219-0-01	S20398-0-01	S19301-0-01
EF4-N21-45-7	2.2*7	S25193-0-01	S19244-1-01	S19219-0-01	S20398-0-01	S19301-0-01
EF4-N31-63-3	3*3	S20234-0-01	S20245-0-01	S20241-1-01	S20404-0-01	S19313-2-01
EF4-N31-63-4	3*4	S20235-0-01	S20245-0-01	S20241-1-01	S20404-0-01	S19313-2-01
EF4-N31-63-5	3*5	S20236-0-01	S20245-0-01	S20241-1-01	S20404-0-01	S19313-2-01
EF4-N31-63-7	3*7	S25196-0-01	S20245-0-01	S20241-1-01	S20404-0-01	S19313-2-01







兄弟包缝机针位 (BROTHER)







MODEL	SIZE					
机种	尺寸	NEEDLE PLATE 针板	DIFF FEED DOG 牙齿	MAIN FEED DOG 牙齿	NEEDLE CLAMP 针头	PRESSER FOOT 压脚
EF4-N31-65-4	5*4	S20231-0-01	S20244-0-01	S20239-1-01	S20406-0-01	S19317-1-01
EF4-N31-65-5	5*5	S20232-0-01	S20244-0-01	S20239-1-01	S20406-0-02	S19317-1-01
EF4-N31-65-6	5*6	S20233-0-01	S20244-0-01	S20239-1-01	S20406-0-03	S19317-1-01
EF4-N31-65-7	5*7	S25197-0-01	S20244-0-01	S20239-1-01	S20406-0-04	S19317-1-01
EF4-N31-69-4	3*4	S19497-0-01	S19246-0-01	S19224-2-01	S20404-0-01	S19321-1-01
EF4-N31-69-5	3*5	S19182-0-01	S19246-0-01	S19224-2-01	S20404-0-01	S19321-1-01
MA4-N31-71-5	5*5	S19183-0-01	S19246-0-01	S19226-1-01	S20406-0-01	S19326-1-01
MA4-N31-71-6	5*6	S19184-0-01	S19246-0-01	S19226-1-01	S20406-0-01	S19326-1-01
MA4-N31-75-5	3*5	S19182-0-01	S19246-0-01	S19224-2-01	S20404-0-01	S25550-0-01
MA4-N31-77-5	5*5	S19183-0-01	S19246-0-01	S19226-1-01	S20406-0-01	S25555-0-01
MA4-N31-77-6	5*6	S19184-0-01	S19246-0-01	S19226-1-01	S20406-0-01	S25555-0-01
MA4-N31-81-4	3*4	S20235-0-01	S20245-0-01	S20241-1-01	S20404-0-01	S19330-2-01
MA4-N31-81-5	3*5	S20236-0-01	S20245-0-01	S20241-1-01	S20404-0-01	S19330-2-01
MA4-N31-83-4	5*4	S20231-0-01	S20244-0-01	S20239-1-01	S20406-0-01	S20882-2-01
MA4-N31-83-5	5*5	S20232-0-01	S20244-0-01	S20239-1-01	S20406-0-01	S20882-2-01
MA4-N31-83-6	5*6	S20233-0-01	S20244-0-01	S20239-1-01	S20406-0-01	S20882-2-01
MA4-N31-92-5	5*5	S19185-0-01	S19247-0-01	S19228-1-01	S21104-0-01	S19334-0-01
MA4-N31-92-6	5*6	S19186-0-01	S19247-0-01	S19228-1-01	S21104-0-01	S19334-0-01
MA4-N31-92-7	5*7	S19187-0-01	S19247-0-01	S19228-1-01	S21104-0-01	S19334-0-01
MA4-N31-95-5B	5.2*5	S31975-0-01	S20244-0-01	S20239-1-01	S29148-0-01	S25562-1-01





MODEL					
机种	NEEDLE PLATE 针板	DIFF FEED DOG 牙齿	MAIN FEED DOG 牙齿	NEEDLE CLAMP 针头	PRESSER FOOT 压脚
737-504F1-04	E784	H442	D569	KG131	P152/F155
737-504M1-15	E934	H442	D290	KG131	P152/F525
737-504M2-04	E800	H445	D575	KG131	P253/F371
737-504M2-04LFC-2	E800	H445	D575	KG131	P101/F371
737-504M3-04	E796	H445	D574	KG131	P230/F371
737-504M3-05	E797	H445	D574	KG131	P230/F371
737-504M5-04	E589	H974	D390	KG131	P975/F380
737-504M5-05	E590	H974	D390	KG131	P975/F380
737-504H4-04	E800	H959	D996	KG131	P136
737-505F1-03	E783	H442	D569	KG131	P152/F155
737-505F1-04	E784	H442	D569	KG131	P152/F155
747-512M1-24	E809	H445	D575	KG142	P253/F374
747-512M1-25	E810	H445	D575	KG142	P253/F374
747-512M8-23	E804A	H446	D576	KG142	P230/F503
747-512M8-25	E810A	H446	D577	KG142	P253/F374
747-514M2-24	E809	H445	D575	KG142	P253/F374
747-514M2-24LF-B	E809	H445	D575	KG142	P101/F374
747-514M2-25	E810	H445	D575	KG142	P253/F374
747-514M4-23	E804	H445	D574	KG142	P230/F503
747-514M4-24	E805	H445	D574	KG142	P230/F374
747-514M5-23	E591	H974	D390	KG142	P975/F381
747-514M7-23	E804A	H446	D576	KG142	P230/F503
747-514M7-24	E809A	D446	D577	KG142	P253/F374
747-514H4-24	E809	H959	D996	KG142	P136
747-514H4-25	E810	H959	D996	KG142	P136
757-516L1-24	E834	H492	D579	KG152	P500
757-516L1-35	E839	H492	D579	KG153	P501
757-516M1-55	E851	H494	D581	KG155	P502
757-516M2-35	E982	H497	D581	KG153	P504
757-516M2-55	E986	H500	D581	KG155	P502
757-516H1-55	E851	H495	D582	KG155	P502
757-516H2-56	E868	H501	D582	KG155	P502
757-516H4-35	E982	H957	D002	KG153	P508
757-516H4-55	E986	H957	D003	KG155	P509
757-516X1-55	E853	H495	D582	KG155	P955
757-516X1-56	E854	H495	D582	KG155	P955
757-516X2-56	E868	H501	D582	KG155	P955
767-516M2-324	E989	H497	D581	KG333	P233
767-516M2-524	E988	H500	D581	KG355	P255
767-516H4-324	E989	H957	D002	KG333	P510
767-516H4-524	E988	H957	D003	KG355	P511
747F-512M1-25	E920	H445	D575	KG142-E	P253E-4
747F-514M2-24	E919	H445	D575	KG142-E	P253E-4
747F-514M2-24LF-B	E919	H445	D575	KG142-E	P101-4
747F-514M2-24LFC-2	E919	H445	D575	KG142-E	P101-4





MODEL	SIZE						
机种	尺寸	NEEDLE PLATE 针板	DIFF FEED DOG 牙齿	MAIN FEED DOG 牙齿	MAIN FEED DOG 牙齿	NEEDLE CLAMP 针头	PRESSER FOOT 压脚
DC-1H DCY100	1.6MM	38506	37455	37456	*	*	37500
DC-1H DCY100	2.3MM	38507	37455	37456	*	*	37500
DC-1H DCY100	3.3MM	38508	37455	37456	*	*	37533
DC-1HA DCY100A	1.6MM	38506	37249	*	*	*	37500
DC-1HA DCY100A	2.3MM	38507	37249	*	*	*	37500
DC-1HA DCY100A	3.3MM	38508	37249	*	*	*	37533
DCY104 DCY114	*	37483	37273	*	*	*	37496
DCY108	*	37800	37439	*	*	*	37848
DCY109	*	37459	37439	*	*	*	37848
DCY251A	*	38352	38322	*	*	38101	38120
DCY251Y	*	38241	38322	*	*	38011	38120
DCZ203-D1	0*1	32671	33813	33814	32883	*	32747
DCZ203-D2	0*2	32672	33813	33814	32883	*	36595
DCZ203-D3	0*3	32673	33813	33814	32883	*	36595
DCZ200-D1	0*1	32666	33810	33811	32883	*	32735
DCZ200-D2	0*2	32667	33810	33811	32883	*	32734
DCZ200-1-D1	0*1	34893	34852	34851	32883	*	32345
DCZ200-1-D2	0*2	34894	34852	34851	32883	*	32355
DCZ201-D1	0*1	35666	33810	33811	32883	*	32738
DCZ201-D2	0*2	35667	33810	33811	32883	*	32739
DCZ204	*	35377	33819	33818	35376	*	35373
DCZ216	*	34420	33812	33811	33328	*	34922
DCZ220-D1 DCZ270-D1	*	33353	33813	33814	32883	34927	32750
DCZ220W-D1 DCZ270W-D1	*	32678	33813	33814	32883	34914	32760
DCZ221-D1	*	33821	33813	33814	32341	37373	32343
DCZ361A-D1	3.2*1	33540	33824	33825	33544	38101	33537
DCZ361A-D2	3.2*2	33541	33824	33825	33544	38101	33537
DCZ361Y-D1	2.4*1	33542	33824	33825	33544	38011	33538
DCZ361Y-D2	2.4*2	33543	33824	33825	33544	38011	33538
DCZ361C-D3	5*3	33545	33828	33829	33328	33247	33539





MODEL	SIZE						
机种	尺寸	NEEDLE PLATE 针板	DIFF FEED DOG 牙齿	MAIN FEED DOG 牙齿	MAIN FEED DOG 牙齿	NEEDLE CLAMP 针头	PRESSER FOOT 压脚
DCZ365A/367A-ND2	3.2*2	33541	33307	33308	33558	38101	33300
DCZ365C-ND3	5*3	33545	33315	33557	35264	33247	33312
DCA341C-D4	5*4	35334	35335	35331	35264	35245	35263
DCZ503-D1	0*1	34564	33840	33814	32883	*	32747
DCZ503-D2	0*2	34565	33840	33814	32883	*	32748
DCZ503-D3	0*3	34566	33840	33814	32883	*	32748
DCZ503-D4	0*4	34567	33841	33814	32883	*	32394
DCZ500-D1	0*1	34530	33839	33811	32883	*	32735
DCZ500-D2	0*2	34531	33839	33811	32883	*	32734
DCZ500-D3	0*3	34532	33839	33811	32883	*	32734
DCZ501-D1	0*1	34530	33839	33811	32883	*	32738
DCZ501-D2	0*2	34531	33839	33811	32883	*	32739
DCZ501-D3	0*3	34532	33839	33811	32883	*	32739
DCZ520-D1	*	34598	33840	33814	32883	34927	32750
DCZ520W-D1	*	34593	33840	33814	32883	34914	32760
DCZ521-D1	*	34600	33840	33814	32341	34927	32343
Z100-A2DF	3.2*2	36568	33824	33825	33544	38101	33537
Z100-A3DF	3.2*3	36569	33824	33825	33544	38101	33537
Z100-A4DF	3.2*4	36570	33824	33825	33544	38101	33537
Z100-C5DF	*	36590	33828	33829	33328	33247	33539
Z365/Z367-A4GF	3.2*4	36570	33307	33308	33558	38101	33300
Z367-C5GF	5*5	36590	33315	33557	35264	33247	33312
Z5003-03	0*3	21768	21846	21842	21009	21002	23000
Z5003-04	0*4	21769	21846	21842	21009	21002	23002
Z5003-05	0*5	21774	21847	21842	21009	21002	23004
Z5020-X4	2*4	21781	21846	21842	21009	21893	23030
Z5020-Y5	2.4*5	21786	21847	21842	21009	21891	23034
Z5020-Y6	2.4*6	21787	21847	21842	21009	21891	23036

MODEL	SIZE						
机种	尺寸	NEEDLE PLATE 针板	DIFF FEED DOG 牙齿	MAIN FEED DOG 牙齿	MAIN FEED DOG 牙齿	NEEDLE CLAMP 针头	PRESSER FOOT 压脚
Z5025-X4	2.4*4	21781	21846	21842	21009	21893	23060
Z5025-X5	2.4*5	21786	21847	21842	21009	21891	23064
Z5025-X6	2.4*6	21787	21847	21842	21009	21891	23066
Z6000-A3	3.2*3	21800	21846	21848	20441	22830	22085
Z6000-A4	3.2*4	21801	21846	21848	20441	22830	22087
Z6000-A5	3.2*5	21812	21847	21848	20441	22830	22089
Z6000-A6	3.2*6	21813	21847	21848	20441	22830	22091
Z6000-C5	5*5	20212	20460	20461	20441	22831	22131
Z6000-C6	5*6	22075	20460	20461	20441	22831	22133
Z6005-A4	3.2*4	21801	21849	21850	20441	22830	23100
Z6005-C5	5*5	20212	20674	20675	20441	22831	23102
Z6006-A4	3.2*4	21801	21849	21850	20441	22830	23104
Z6006-C5	5*5	20212	20674	20675	20441	22831	23106
Z6100-C5	5*5	22220	22222	22223	20441	22234	22230
Z6102-C5	5*5	22220	22222	22223	20441	22234	22230
AZ6003H-03	0*3	2108002	2109007	2109006	2109052	2109132	2107300
AZ6003H-04	0*4	2108003	2109005	2109006	2109052	2109132	2107301
AZ6003H-05	0*5	2108007	2109005	2109006	2109052	2109132	2107302
AZ6003H-06	0*6	2108012	2109009	2109006	2109052	2109132	2107303
AZ6000H-03	0*3	2108001	2109000	2109001	2109052	2109132	2107031
AZ6000H-04	0*4	2108000	2109000	2109001	2109052	2109132	2107032
AZ6016H-02	*	2108016	2109017	2109018	2109019	2109132	2107084
AZ6020H-Y5	2.4*5	2108004	2109005	2109006	2109052	2109130	2107310
AZ6020H-Y6	2.4*6	2108005	2109009	2109006	2109052	2109130	2107311
AZ6020H-X4	2.0*4	2108006	2109005	2109006	2109052	2109131	2107312
AZ6020H-X5	2.0*5	2108014	2109005	2109006	2109052	2109131	2107313
AZ6025H-Y5	2.4*5	2108004	2109005	2109006	2109052	2109130	2107077
AZ6025H-Y6	2.4*6	2108005	2109009	2109006	2109052	2109130	2107078
AZ6025H-X4	2.0*4	2108006	2109005	2109006	2109052	2109131	2107079
AZ6025H-X5	2.0*5	2108014	2109005	2109006	2109052	2109131	2107081

MODEL	SIZE						
机种	尺寸	NEEDLE PLATE 针板	DIFF FEED DOG 牙齿	MAIN FEED DOG 牙齿	MAIN FEED DOG 牙齿	NEEDLE CLAMP 针头	PRESSER FOOT 压脚
AZ6025H-Y5	2.4*5	2108004	2109005	2109006	2109052	2109130	2107077
AZ6025H-Y6	2.4*6	2108005	2109009	2109006	2109052	2109130	2107078
AZ6025H-X4	2.0*4	2108006	2109005	2109006	2109052	2109131	2107079
AZ6025H-X5	2.0*5	2108014	2109005	2109006	2109052	2109131	2107081
AZ6500H-A4	3.2*4	2108050	2109050	2109051	2109052	2109120	2107100
AZ6500H-A5	3.2*5	2108051	2109050	2109051	2109052	2109120	2107124
AZ6500H-A6	3.2*6	2108056	2109057	2109051	2109052	2109120	2107125
AZ6500H-C5	5*5	2108052	2109055	2109056	2109052	2109122	2107102
AZ6500H-C6	5*6	2108053	2109055	2109056	2109052	2109122	2107126
AZ6505H-A4	3.2*4	2108050	2109060	2109061	2109052	2109120	2107147
AZ6505H-C5	5*5	2108052	2109062	2109063	2109052	2109122	2107149
AZ8003H-03	0*3	2108002	2109007	2109006	2109067	2109100	2107300
AZ8003H-04	0*4	2108003	2109005	2109006	2109067	2109100	2107301
AZ8003H-05	0*5	2108007	2109005	2109006	2109067	2109100	2107302
AZ8003H-06	0*6	2108012	2109009	2109006	2109067	2109100	2107303
AZ8000H-03	0*3	2108001	2109000	2109001	2109067	2109100	2107031
AZ8000H-04	0*4	2108000	2109000	2109001	2109067	2109100	2107032
AZ8016H-02	0*2	2108016	2109017	2109018	2109019	2109100	2107084
AZ8020H-Y5	2.4*5	2108004	2109005	2109006	2109067	2109101	2107310
AZ8020H-Y6	2.4*6	2108005	2109009	2109006	2109067	2109101	2107311
AZ8020H-X4	2.0*4	2108006	2109005	2109006	2109067	2109102	2107312
AZ8020H-X5	2.0*5	2108014	2109005	2109006	2109067	2109102	2107313
AZ8025H-Y5	2.4*5	2108004	2109005	2109006	2109067	2109101	2107308
AZ8025H-Y6	2.4*6	2108005	2109009	2109006	2109067	2109101	2107309
AZ8025H-X4	2.0*4	2108006	2109005	2109006	2109067	2109102	2107306
AZ8500H-A4	3.2*4	2108050	2109050	2109051	2109052	2109110	2107100
AZ8500H-A5	3.2*5	2108051	2109050	2109051	2109052	2109110	2107124
AZ8500H-A6	3.2*6	2108056	2109057	2109051	2109052	2109110	2107125
AZ8500H-C5	5*5	2108052	2109055	2109056	2109052	2109112	2107102
AZ8500H-C6	6*6	2108053	2109055	2109056	2109052	2109112	2107126
AZ8505H-A4	3.2*4	2108050	2109060	2109061	2109052	2109110	2107147
AZ8505H-C5	5*5	2108052	2109062	2109063	2109052	2109112	2107149

MODEL	SIZE					
		NEEDLE PLATE 针板	DIFF FEED DOG 牙齿	MAIN FEED DOG 牙齿	NEEDLE CLAMP 针头	PRESSER FOOT 压脚
机种	尺寸					
DW3-1	356	200475	200478	*	192071	200483
DW3-2	356	200479	200477	*	192071	193084
W61-01	356	206276	206283	206279	206855	206874
W61-01	364	206277	206283	206279	206856	206876
W61-02	356	206455	206285	206281	206855	206443
W61-02	364	206456	206285	206281	206856	206444
W61-05	356	206399	306401	206281	206855	306405
W61-05	364	206400	306401	206281	206856	306406
WS62-01	356	206276	206820	206818	207059	206874
WS62-01	364	206277	206820	206818	207060	206876
W541-01CB	224	257015B24	257258-16F	257206-16F	257517-24	157462-24
W541-01CB	232	257015B32	257258-16F	257206-16F	257517-32	257462-32
W541-01CB	240	257015B40	257258-16F	257206-16F	257517-40	257462-40
W541-01CB	248	257015B48	257258-16F	257206-16F	257517-48	257462-48
W541-01CB	256	257017B56	257259-16F	257207-16F	257517-56	257462-56
W541-01CB	264	257017B64	257259-16F	257207-16F	257517-64	257462-64
W541-01CB	348	257016B48	257258-16F	257206-16F	257518-48	257463-48
W541-01CB	356	257018B56	257259-16F	257207-16F	257518-56	257463-56
W541-01CB	364	257018B64	257259-16F	257207-16F	257518-64	257463-64
W541-02BB	224	257029B24	257260-16F	257214-16F	257517-24	257322A24
W541-02BB	232	257029B32	257260-16F	257214-16F	257517-32	257322A32
W541-02BB	240	257030B40	257261-16F	257215-16F	257517-40	257323A40
W541-02BB	248	257030B48	257261-16F	257215-16F	257517-48	257323A48
W541-02BB	256	257032B56	257262-16F	257216-16F	257517-56	257324A56
W541-02BB	264	257032B64	257262-16F	257216-16F	257517-64	257324A64
W541-02BB	348	257031B48	257261-16F	257215-16F	257518-48	257325A48
W541-02BB	356	257033B56	257262-16F	257216-16F	257518-56	257326A56
W541-02BB	364	257033B64	257262-16F	257216-16F	257518-64	257326A64
W541-03DB	240	257087B40	259200-16F	257206-16F	257517-40	257469-40
W541-03DB	248	257087B48	259200-16F	257206-16F	257517-48	257469-48
W541-03DB	256	257089B56	257253-16F	257507-16F	257517-56	257469-56
W541-03DB	264	257089B64	257253-17F	257507-16F	257517-64	257469-64
W541-03DB	348	257088B48	259200-16F	257206-16F	257518-48	257470-48
W541-03DB	356	257090B56	257253-16F	257207-16F	257518-56	257470-56
W541-03DB	364	257090B64	257253-17F	257207-16F	257518-64	257470-64
W541-03EB	240	257091B40	259201-16F	257206-16F	257517-40	257469-40
W541-03EB	248	257091B48	259201-16F	257206-16F	257517-48	257469-48
W541-03EB	256	257093B56	257254-16F	257207-16F	257517-56	257469-56
W541-03EB	264	257093B64	257254-16F	257207-16F	257517-64	257469-64
W541-03EB	348	257092B48	259201-16F	257206-16F	257518-48	257470-48
W541-03EB	356	257094B56	257254-16F	257207-16F	257518-56	257470-56
W541-03EB	364	257094B64	257254-16F	257207-16F	257518-64	257470-64
W541-05BB	224	257049B24	257266-16F	257220-16F	257517-24	257332A24
W541-05BB	232	257049B32	257266-16F	257220-16F	257517-32	257332A32
W541-05BB	240	257050B40	257267-16F	257221-16F	257517-40	257333A40
W541-05BB	248	257050B48	257267-16F	257221-16F	257517-48	257333A48
W541-05BB	256	257052B56	257268-16F	257222-16F	257517-56	257334A56
W541-05BB	264	257052B64	257268-16F	257222-16F	257517-64	257334A64
W541-05BB	348	257051B48	257267-16F	257221-16F	257518-48	257335A48





MODEL	SIZE					
		NEEDLE PLATE 针板	DIFF FEED DOG 牙齿	MAIN FEED DOG 牙齿	NEEDLE CLAMP 针头	PRESSER FOOT 压脚
机种	尺寸					
W541-05BB	356	257053B56	257268-16F	257222-16F	257518-56	257336A56
W541-05BB	364	257053B64	257268-16F	257222-16F	257518-64	257336A64
W561-01CB	224	257015B24	257258-16F	257206-16F	257517-24	257460-24
W561-01CB	232	257015B32	257258-16F	257206-16F	257517-32	257460-32
W561-01CB	240	257015B40	257258-16F	257206-16F	257517-40	257460-40
W561-01CB	248	257015B48	257258-16F	257206-16F	257517-48	257460-48
W561-01CB	256	257017B56	257259-16F	257207-16F	257517-56	257460-56
W561-01CB	264	257017B64	257259-16F	257207-16F	257517-64	257460-64
W561-01CB	348	257016B48	257258-16F	257206-16F	257518-48	257461-48
W561-01CB	356	257018B56	257259-16F	257207-16F	257518-56	257461-56
W561-01CB	364	257018B64	257259-16F	257207-16F	257518-64	257461-64
W561-02BB	224	257029B24	257260-16F	257214-16F	257517-24	257317A24
W561-02BB	232	257029B32	257260-16F	257214-16F	257517-32	257317A32
W561-02BB	240	257030B40	257261-16F	257215-16F	257517-40	257318A40
W561-02BB	248	257030B48	257261-16F	257215-16F	257517-48	257318A48
W561-02BB	256	257032B56	257262-16F	257216-16F	257517-56	257319A56
W561-02BB	264	257032B64	257262-16F	257216-16F	257517-64	257319A64
W561-02BB	348	257031B48	257261-16F	257215-16F	257518-48	257320A48
W561-02BB	356	257033B56	257262-16F	257215-16F	257518-56	257321A56
W561-02BB	364	257033B64	257262-16F	257216-16F	257518-64	257321A64
W561-03DB	240	257087B40	259200-16F	257206-16F	257517-40	257467-40
W561-03DB	248	257087B48	259200-16F	257206-16F	257517-48	257467-48
W561-03DB	256	257087B56	257253-16F	257207-16F	257517-56	257467-56
W561-03DB	264	257087B64	257253-16F	257207-16F	257517-64	257467-64
W561-03DB	348	257088B48	259200-16F	257206-16F	257518-48	257468-48
W561-03DB	356	257090B56	257253-16F	257207-16F	257518-56	257468-56
W561-03DB	364	257090B64	257253-16F	257207-16F	257518-64	257468-64
W561-03EB	240	257091B40	259201-16F	257206-16F	257517-40	257467-40
W561-03EB	248	257091B48	259201-16F	257206-16F	257517-48	257467-48
W561-03EB	256	257093B56	257254-16F	257207-16F	257517-56	257467-56
W561-03EB	264	257093B64	257254-16F	257207-16F	257517-64	257467-64
W561-03EB	348	257092B48	259201-16F	257206-16F	257518-48	257468-48
W561-03EB	356	257094B56	257254-16F	257207-16F	257518-56	257468-56
W561-03EB	364	257094B64	257254-16F	257207-16F	257518-64	257468-64
W561-05BB	224	257049B24	257266-16F	257220-16F	257517-24	257327A24
W561-05BB	232	257049B32	257266-16F	257220-16F	257517-32	257327A32
W561-05BB	240	257050B40	257267-16F	257221-16F	257517-40	257328A40
W561-05BB	248	257050B48	257267-16F	257221-16F	257517-48	257328A48
W561-05BB	256	257052B56	257268-16F	257222-16F	257517-56	257329A56
W561-05BB	264	257052B64	257268-16F	257222-16F	257517-64	257329A64
W561-05BB	348	257051B48	257267-16F	257221-16F	257518-48	257330A48
W561-05BB	356	257053B56	257268-16F	257222-16F	257518-56	257331A56
W561-05BB	364	257053B64	257268-16F	257222-16F	257518-64	257331A64
W644-01CB	232	257015B32	257289-16F	257242-16F	257517-32	257462-32
W644-01CB	240	257015B40	257289-16F	257242-16F	257517-40	257462-40
W644-01CB	248	257015B48	257289-16F	257242-16F	257517-48	257462-48
W644-01CB	256	257017B56	257290-16F	257243-16F	257517-56	257462-56
W644-01CB	264	257017B64	257290-16F	257243-16F	257517-64	257462-64
W644-01CB	356	257018B56	257290-16F	257243-16F	257518-56	257463-56

MODEL	SIZE					
机种	尺寸	NEEDLE PLATE 针板	DIFF FEED DOG 牙齿	MAIN FEED DOG 牙齿	NEEDLE CLAMP 针头	PRESSER FOOT 压脚
W644-01CB	364	257018B64	257290-16F	257243-16F	257518-64	257463-64
W644-02BB	232	257029B32	257291-16F	257244-16F	257517-32	257322A32
W644-02BB	240	257030B40	257292-16F	257245-16F	257517-40	257323A40
W644-02BB	248	257030B48	257292-16F	257245-16F	257517-48	257323A48
W644-02BB	256	257032B56	257293-16F	257246-16F	257517-56	257324A56
W644-02BB	264	257032B64	257293-16F	257246-16F	257517-64	257324A64
W644-02BB	356	257033B56	257293-16F	257246-16F	257518-56	257326A56
W644-02BB	364	257033B64	257293-16F	257246-16F	257518-64	257326A64
W644-03FB	232	257098B32	259214-16F	257242-16F	257517-32	257469-32
W644-03FB	240	257098B40	259214-16F	257242-16F	257517-40	257469-40
W644-03FB	248	257099B48	259214-16F	259102-16F	257517-48	257469-48
W644-03FB	256	257096B56	259215-16F	259103-16F	257517-56	257469-56
W644-03FB	264	257096B64	259215-16F	259103-16F	257517-64	257469-64
W644-03FB	356	257097B56	259215-16F	259103-16F	257518-56	257470-56
W644-03FB	364	257097B64	259215-16F	259103-16F	257518-64	257470-64
W644-05BB	232	257049B32	259216-16F	259104-16F	257517-32	257422-32
W644-05BB	240	257050B40	259217-16F	259105-16F	257517-40	257423-40
W644-05BB	248	257050B48	259217-16F	259105-16F	257517-48	257423-48
W644-05BB	256	257052B56	259218-16F	259106-16F	257517-56	257424-56
W644-05BB	264	257052B64	259218-16F	259106-16F	257517-64	257424-64
W644-05BB	356	257053B56	259218-16F	259106-16F	257518-56	257425-56
W644-05BB	364	257053B64	259218-16F	259106-16F	257518-64	257425-64
W664-01CB	232	257015B32	257289-16F	257242-16F	257517-32	257460-32
W664-01CB	240	257015B40	257289-16F	257242-16F	257517-40	257460-40
W664-01CB	248	257015B48	257289-16F	257242-16F	257517-48	257460-48
W664-01CB	256	257017B56	257290-16F	257243-16F	257517-56	257460-56
W664-01CB	264	257017B64	257290-16F	257243-16F	257517-64	257460-64
W664-01CB	356	257018B56	257290-16F	257243-16F	257518-56	257461-56
W664-01CB	364	257018B64	257290-16F	257243-16F	257518-64	257461-64
W664-02BB	232	257029B32	257291-16F	257244-16F	257517-32	257317A32
W664-02BB	240	257030B40	257292-16F	257245-16F	257517-40	257318A40
W664-02BB	248	257030B48	257292-16F	257245-16F	257517-48	257318A48
W664-02BB	256	257032B56	257293-16F	257246-16F	257517-56	257319A56
W664-02BB	264	257032B64	257293-16F	257246-16F	257517-64	257319A64
W664-02BB	356	257033B56	257293-16F	257246-16F	257518-56	257321A56
W664-02BB	364	257033B64	257293-16F	257246-16F	257518-64	257321A64
W664-03FB	232	257098B32	259214-16F	257242-16F	257517-32	257467-32
W664-03FB	240	257098B40	259214-16F	257242-16F	257517-40	257467-40
W664-03FB	248	257099B48	259214-16F	259102-16F	257517-48	257467-48
W664-03FB	256	257096B56	259215-16F	259103-16F	257517-56	257467-56
W664-03FB	264	257096B64	259215-16F	259103-16F	257517-64	257467-64
W664-03FB	356	257097B56	259215-16F	259103-16F	257518-56	257468-56
W664-03FB	364	257097B64	259215-16F	259103-16F	257518-64	257468-64
W664-05BB	232	257049B32	259216-16F	259104-16F	257517-32	257418-32
W664-05BB	240	257050B40	259217-16F	259105-16F	257517-40	257419-40
W664-05BB	248	257050B48	259217-16F	259105-16F	257517-48	257419-48
W664-05BB	256	257052B56	259218-16F	259106-16F	257517-56	257420-56
W664-05BB	264	257052B64	259218-16F	259106-16F	257517-64	257420-64
W664-05BB	356	257053B56	259218-16F	259106-16F	257518-56	257421-56
W664-05BB	364	257053B64	259218-16F	259106-16F	257518-64	257421-64

兄弟绷缝机针位 (BROTHER)





MODEL	SIZE							
机种	尺寸	NEEDLE PLATE 针板	DIFF FEED DOG 牙齿	MAIN FEED DOG 牙齿	NEEDLE CLAMP 针头	PRESSER FOOT 压脚		
FD4-B272-011-1	232	S08717-0-01	S08885-0-01	S08882-0-01	S08699-0-01	S08779-0-01		
FD4-B272-011-2	240	S08718-0-01			S08701-0-01	S08786-0-01		
FD4-B272-011-3	248	S08719-0-01			S08703-0-01	S08788-0-01		
FD4-B272-011-4	256	S08720-0-01			S08705-0-01	S08790-0-01		
FD4-B272-011-5	264	S08721-0-01			S08707-0-01	S08792-0-01		
FD4-B272-011-6	348	S08722-0-01			S08709-0-01	S08794-0-01		
FD4-B272-011-7	356	S08723-0-01			S08711-0-01	S08796-0-01		
FD4-B272-011-8	364	S08724-0-01			S08713-0-01	S08798-0-01		
FD4-B272-021-1	232	S08725-0-01	S08886-0-01	S08883-0-01	S08699-0-01	S08800-0-01		
FD4-B272-021-2	240	S08726-0-01			S08701-0-01	S08813-0-01		
FD4-B272-021-3	248	S08727-0-01			S08703-0-01	S08815-0-01		
FD4-B272-021-4	256	S08728-0-01			S08705-0-01	S08818-0-01		
FD4-B272-021-5	264	S08729-0-01			S08707-0-01	S08820-0-01		
FD4-B272-021-6	348	S08730-0-01			S08709-0-01	S08822-0-01		
FD4-B272-021-7	356	S08731-0-01			S08711-0-01	S08824-0-01		
FD4-B272-021-8	364	S08732-0-01			S08713-0-01	S08826-0-01		
FD4-B272-031-3	248	S08733-0-01	S08887-0-01	S08882-0-01	S08703-0-01	S08828-0-01		
FD4-B272-031-4	256	S08734-0-01			S08705-0-01	S08830-0-01		
FD4-B272-031-5	264	S08735-0-01			S08707-0-01	S08832-0-01		
FD4-B272-031-6	348	S08736-0-01			S08709-0-01	S08834-0-01		
FD4-B272-031-7	356	S08737-0-01			S08711-0-01	S08836-0-01		
FD4-B272-031-8	364	S08738-0-01			S08713-0-01	S08838-0-01		
FD4-B272-071-1	232	S08739-0-01			S08888-0-01	S08883-0-01	S08699-0-01	S08840-0-01
FD4-B272-071-2	240	S08740-0-01					S08701-0-01	S08848-0-01
FD4-B272-071-3	248	S08741-0-01	S08703-0-01	S08850-0-01				
FD4-B272-071-4	256	S08742-0-01	S08705-0-01	S08852-0-01				
FD4-B272-071-5	264	S08743-0-01	S08707-0-01	S08854-0-01				
FD4-B272-071-6	348	S08744-0-01	S08709-0-01	S08856-0-01				
FD4-B272-071-7	356	S08745-0-01	S08711-0-01	S08858-0-01				
FD4-B272-071-8	364	S08746-0-01	S08713-0-01	S08860-0-01				

MODEL	SIZE					
機種	尺寸	NEEDLE PLATE 针板	DIFF FEED DOG 牙齿	MAIN FEED DOG 牙齿	NEEDLE HOLDER 针头	PRESSER FOOT 压脚
W122/CH W122/CH/UTP ( UTR )	240	E3524P	H4258	D4206	M4240	P0024
	248	E3525P	H4258	D4206	M4248	P0025
	256	E3826S	H4258	D4206	M4356	P0216
	356	E3826P	H4258	D4206	M4356	P0216
	364	E3827P	H4259	D4207	M4364	P0217
U122/CH U122/CH/UTQ ( UTS )	240	E3524P	H4258	D4206	M4240	P0314
	248	E3525P	H4258	D4206	M4248	P0315
	256	E3826S	H4258	D4206	M4356	P0416
	356	E3826P	H4258	D4206	M4356	P0416
	364	E3827P	H4259	D4207	M4364	P0417
W132/CHE W132/CHE/UTP ( UTR )	240	E2326	H2219	D2109	M4240	P2906
	248	E2327	H2219	D2109	M4248	P2907
	356	E2326	H2220	D2110	M4356	P2906
	364	E2327	H2220	D2110	M4364	P2907
W152/CZ/CL/UTQ/RLQ U152/CZ/CL/UTQ/RLQ	356	E4326P	H3262	D3216	M4356	P2416
	364	E4327P	H3263	D3217	M4364	P2417
W222/CQ	240	E4124P	H3362	D3216	M4240	P1814
	248	E4125P	H3362	D3216	M4248	P1815
	356	E4426P	H3362	D3216	M4356	P2116
	364	E4427P	H3363	D3217	M4364	P2117
U222/CQ	240	E4124P	H3362	D3216	M4240	P2314
	248	E4125P	H3362	D3216	M4248	P2315
	356	E4426P	H3362	D3216	M4356	P2616
	364	E4427P	H3363	D3217	M4364	P2617
W322/CC U322/CC W322/CC/UTP ( UTR ) U322/CC/UTQ ( UTS )	356	E2826P	H3259M	D2107L	M4356	P1406
	364	E2827P	H3259M	D2107L	M4364	P1407
W322/CD U322/CD/UTP ( UTR )	356	E3626P	H4158	D4206	M4356	P1406
	364	E3627P	H4159	D4207	M4364	P1407
U322/CD W322/CD/UTQ ( UTS )	356	E3626P	H4158	D4206	M4356	P1606
	364	E3627P	H4159	D4207	M4364	P1607
W322/CE U322/CE	356	E3626P	H4159	D4207	M4356	P1406
	364	E3627P	H4159	D4207	M4364	P1407





MODEL	SIZE					
機種	尺寸	NEEDLE PLATE 针板	DIFF FEED DOG 牙齿	MAIN FEED DOG 牙齿	NEEDLE HOLDER 针头	PRESSER FOOT 压脚
W322/CE/UTP ( UTR )	356	E2626P	H4159	D4207	M4356	P1406
	364	E2627P	H4159	D4207	M4364	P1407
U322/CE/UTQ ( UTS )	356	E2626P	H4159	D4207	M4356	P1606
	364	E2627P	H4159	D4207	M4364	P1607
U322/CF U322/CF/UTQ ( UTS )	248	E2625P	H3158	D2106	M4348	P1605
W512/FE ( FFC )	240	E3524	H4258	D4206	M4240	P2914
	356	E3826	H4258	D4206	M4356	P3216
	364	E3827	H4259	D4207	M4364	P3217
U512/FE ( FFC )	240	E3524	H4258	D4206	M4240	P3414
	356	E3826	H4258	D4206	M4356	P3716
	364	E3827	H4259	D4207	M4364	P3717
W522/FE ( FFC ) /CRA/CL W522/FE ( FFC ) /CRB/CL U522/FE ( FFC ) /CRA/CL U522/FE ( FFC ) /CRB/CL	356	E3826	H3268	D3222	M4356	P3826
	364	E3827	H3268	D3222	M4364	P3827
W532/CRA/UTP/CL/RLP/CX W532/CRA/UTQ/CL/RLP/CX	356	E6426	H3268	D3222	M4356	P3816
	364	E6427	H3268	D3222	M4364	P3817
W542/CFC ( CFF ) /CL U542/CFC ( CFE ) /CL	240	E2324	H2219	D2109	M4240	P2904
	248	E2325	H2219	D2109	M4248	P2905
	356	E2326	H2220	D2110	M4356	P2906
	364	E2327	H2220	D2110	M4364	P2907
W812/CRL/RL W812/CRL/CHP/RL W812/CRL/CHP/UTP/RL W822/CRL/CY/CL/RL W822/CRL/CY/UTP/CL/RL	356	E0226P	H2203	D2101	M4356	P2766
	364	E0227P	H2203	D2101	M4364	P2767
U812/CRL/RL U812/CRL/CHP/RL UW812/CRL/CHP/UTQ/RL W822/CRL/CY/CL/RL U822/CRL/CY/UTQ/CL/RL	356	E0226P	H2203	D2101	M4356	P0966
	364	E0227P	H2203	D2102	M4364	P0967





MODEL	SIZE					
机种	尺寸	NEEDLE PLATE 针板	DIFF FEED DOG 牙齿	MAIN FEED DOG 牙齿	NEEDLE CLAMP 针头	PRESSER FOOT 压脚
W122 W122/UTG (UTJ)	240	E1524	H1258	D1206	M4240	P0024
	248	E1525	H1258	D1206	M4248	P0025
	356	E1826	H1259	D1207	M4356	P0216
	364	E1827	H1259	D1207	M4364	P0217
U122 U122/UTH (UTK)	240	E1524	H1258	D1206	M4240	P0314
	248	E1525	H1258	D1206	M4248	P0315
	356	E1826	H1259	D1207	M4356	P0416
	364	E1827	H1259	D1207	M4364	P0417
F007F-U122/FP	232	E1623	H1257	D1206	M4232	P4011
W123 W123/UTG (UTJ)	240	E1534	H1258	D1206	M4240	P0024
	248	E1535	H1258	D1206	M4248	P0025
	356	E1836	H1259	D1207	M4356	P0216
	364	E1837	H1259	D1207	M4364	P0217
W162 W162/UTG (UTJ)	356	E1846	H1259	D1207	M4356	P0226
	364	E1847	H1259	D1207	M4364	P0227
W222/FQ W222/FQ/FE/FAC W222/FFD (FFP)	240	E3024	H1261	D1215	M4240	P1814
	248	E3025	H1261	D1215	M4248	P1815
	356	E3326	H1262	D1216	M4356	P2116
	364	E3327	H1262	D1216	M4364	P2117
U222/FQ U222/FFD (FFP)	240	E3024	H1261	D1215	M4240	P2314
	248	E3025	H1261	D1215	M4248	P2315
	356	E3326	H1262	D1216	M4356	P2616
	364	E3327	H1262	D1216	M4364	P2617
W222A/FQ/FEC (FAC)	240	E3124	H1261	D1315	M4240	P1914
	248	E3125	H1261	D1315	M4248	P1915
	356	E3426	H1262	D1316	M4356	P2216
	364	E3427	H1262	D1316	M4364	P2217
W223	240	E3034	H1261	D1215	M4240	P1814
	356	E3336	H1262	D1216	M4356	P2116
	364	E3337	H1262	D1216	M4364	P2117
W322/FDC W322/UTG (UTK) /FDC	356	E4826	H1359	D1207	M4356	P1406
	364	E4827	H1359	D1207	M4364	P1407
U322/FDC U322/UTG (UTK) /FDC	356	E4826	H1359	D1207	M4356	P1606
	364	E4827	H1359	D1207	M4364	P1607
W322/FDE W322/UTG (UTJ) /FDE	356	E4836M	H1459	D1207	M4356	P2406
	364	D4837M	H1459	D1207	M4364	P2407





MODEL	SIZE					
机种	尺寸	NEEDLE PLATE 针板	DIFF FEED DOG 牙齿	MAIN FEED DOG 牙齿	NEEDLE HOLDER 针头	PRESSER FOOT 压脚
U322/FDE U322/UTH (UTK) /FDE	356	E4836M	H1459	D1207	M4356	P2606
	364	E4837M	H1459	D1207	M4364	P2607
W512/FE (FFC)	240	E1524	H1258	D1206	M4240	P2914
	248	E1525	H1258	D1206	M4248	P2915
	356	E1826	H1259	D1207	M4356	P3216
	364	E1827	H1259	D1207	M4364	P3217
U512/FE (FFC)	240	E1524	H1258	D1206	M4240	P3414
	248	E1525	H1258	D1206	M4248	P3415
	356	E1826	H1259	D1207	M4356	P3716
	364	E1827	H1259	D1207	M4364	P3717
W522/FE (FFC) /FR	240	E6024	H2267	D2221	M4240	P2814
	248	E6025	H2267	D2221	M4248	P2815
	356	E6326	H2268	D2222	M4356	P3116
	364	E6327	H2268	D2222	M4364	P3117
U522/FE (FFC) /FR	240	E6024	H2267	D2221	M4240	P3314
	248	E6025	H2267	D2221	M4248	P3315
	356	E6326	H2268	D2222	M4356	P3616
	364	E6327	H2268	D2222	M4364	P3617
U162/FBP	256	E1826	H1259	D1207	M4356	P4000
	264	E1827	H1259	D1207	M4364	P4001
U612/FBQ	256	E1826	H5001	D5001	M4356	P4000
	256	E4001	H5001	D5001	M4356	P4002
	264	E1827	H5001	D5001	M4364	P4001
	264	E4001	H5001	D5001	M4364	P4002
U613/FBP	256	E1836L	H1259	D1207	M4356	P4000
	264	E1837L	H1259	D1207	M4364	P4001
U613/FBQ	256	E1836L	H5001	D5001	M4356	P4000
	256	E4001	H5001	D5001	M4356	P4002
	264	E1837L	H5001	D5001	M4364	P4001
	264	E4001	H5001	D5001	M4364	P4002
U712	264	E5827	H5259	D5207	M5264	P4117
U712/FSP	264	E5827	H5259	D5207	M5264	P5117
U712/FSR	264	E5927	H5359	D5307	M5264	P4217
W722/FY	388	E6828	H6259	D6207	M4388	P6117
W922/FW (FWP)	460	E1828	H1259	D1207	M4460	P2408



MODEL	SIZE					
机种	尺寸	NEEDLE PLATE 针板	FRONT FEED DOG 牙齿	REAR FEED DOG 牙齿	NEEDLE CLAMP 针头	PRESSER FOOT 压脚
DVK1702D	1/8	14-724	15-724	15-755	12-702	17-724
	5/32	14-734	15-724	15-755	12-702	17-734
	3/16	14-744	15-723	15-753	12-702	17-744
	7/32	14-754	15-723	15-753	12-702	17-754
	1/4	14-764	15-723	15-753	12-702	17-764
DVK1703D	7/32 (356)	14-854	15-723	15-753	12-702	17-784
	1/4 (364)	14-864	15-723	15-753	12-702	17-794
DVK1702DE	1/8	14-725	15-724	15-755	12-702	17-725
	5/32	14-735	15-724	15-755	12-702	17-735
	3/16	14-745	15-723	15-753	12-702	17-745
	7/32	14-755	15-723	15-753	12-702	17-755
	1/4	14-765	15-723	15-753	12-702	17-765
DVK1703DE	7/32 (356)	14-855	15-723	15-753	12-702	17-785
	1/4 (364)	14-865	15-723	15-753	12-702	17-795
DVK1702F	1/8 (232)	14-726	15-729	15-758	12-702	17-726
	5/32 (240)	14-736	15-729	15-758	12-702	17-736
	3/16 (248)	14-746	15-726	15-756	12-702	17-746
	7/32 (256)	14-756	15-726	15-756	12-702	17-756
	1/4 (264)	14-766	15-726	15-756	12-702	17-766
DVK1703F	7/32 (356)	14-856	15-726	15-756	12-702	17-786
	1/4 (364)	14-866	15-726	15-756	12-702	17-796
DVK1702E	3/16 (248)	14-745	15-704	15-756	12-702	17-745
	7/32 (256)	14-755	15-704	15-756	12-702	17-755
	1/4 (264)	14-765	15-704	15-756	12-702	17-765
DVK1703E	7/32 (356)	14-855	15-704	15-756	12-702	17-785
	1/4 (364)	14-865	15-704	15-756	12-702	17-795
DVK1702P	3/16 (248)	14-744	15-704	15-756	12-702	17-744
	7/32 (256)	14-754	15-704	15-756	12-702	17-754
	1/4 (264)	14-764	15-704	15-756	12-702	17-764
DWK1802D	1/8	14-724	15-724	15-755	12-702	17-824
	5/32	14-734	15-724	15-755	12-702	17-834
	3/16	14-744	15-723	15-753	12-702	17-844
	7/32	14-754	15-723	15-753	12-702	17-854
	1/4	14-764	15-723	15-753	12-702	17-864
DWK1803D	7/32 (356)	14-854	15-723	15-753	12-702	17-884
	1/4 (364)	14-864	15-723	15-753	12-702	17-894
DWK1804D	15/64 (460)	14-893	15-723	15-753	12-893	17-893





MODEL	SIZE					
机种	尺寸	NEEDLE PLATE 针板	FRONT FEED DOG 牙齿	REAR FEED DOG 牙齿	NEEDLE CLAMP 针头	PRESSER FOOT 压脚
DWK1802DE	1/8	14-725	15-724	15-755	12-702	17-725
	5/32	14-735	15-724	15-755	12-702	17-735
	3/16	14-745	15-723	15-753	12-702	17-745
	7/32	14-755	15-723	15-753	12-702	17-755
	1/4	14-765	15-723	15-753	12-702	17-765
DWK1803DE	7/32 (356)	14-855	15-723	15-753	12-702	17-785
	1/4 (364)	14-865	15-723	15-753	12-702	17-795
DWK1802F	1/8 (232)	14-726	15-729	15-758	12-702	17-826
	5/32 (240)	14-736	15-729	15-758	12-702	17-836
	3/16 (248)	14-746	15-726	15-756	12-702	17-846
	7/32 (256)	14-756	15-726	15-756	12-702	17-856
	1/4 (264)	14-766	15-726	15-756	12-702	17-866
DWK1803F	7/32 (356)	14-856	15-726	15-756	12-702	17-886
	1/4 (364)	14-866	15-726	15-756	12-702	17-896
DWK1802EMK	1/8	14-728	15-728	15-756	12-702	17-828
	5/32	14-738	15-728	15-756	12-702	17-838
	3/16	14-748	15-728	15-756	12-702	17-848
	7/32	14-758	15-728	15-756	12-702	17-858
	1/4	14-768	15-728	15-756	12-702	17-868
DWK1803EMK	7/32 (356)	14-858	15-728	15-756	12-702	17-888
	1/4 (364)	14-868	15-728	15-756	12-702	17-898
V7002D	1/8	14-7240-0	15-7240-0	15-7550-0	12-8110-1	17-7240-1
	5/32	14-7340-0	15-7240-0	15-7550-0	12-8120-1	17-7340-1
	3/16	14-7440-0	15-7230-0	15-7530-0	12-8130-1	17-7440-1
	7/32	14-7540-0	15-7230-0	15-7530-0	12-8140-1	17-7540-1
	1/4	14-7640-0	15-7230-0	15-7530-0	12-8150-1	17-7640-1
V7003D	7/32 (356)	14-8540-0	15-7230-0	15-7530-0	12-8010-1	17-7840-1
	1/4 (364)	14-8640-0	15-7230-0	15-7530-0	12-8020-1	17-7940-1
V7002DE	1/8	14-7250-0	15-7240-0	15-7550-0	12-8110-1	17-7250-1
	5/32	14-7350-0	15-7240-0	15-7550-0	12-8120-1	17-7350-1
	3/16	14-7450-0	15-7230-0	15-7530-0	12-8130-1	17-7450-1
	7/32	14-7550-0	15-7230-0	15-7530-0	12-8140-1	17-7550-1
	1/4	14-7650-0	15-7230-0	15-7530-0	12-8150-1	17-7650-1
V7003DE	7/32 (356)	14-8550-0	15-7230-0	15-7530-0	12-8010-1	17-7850-1
	1/4 (364)	14-8650-0	15-7230-0	15-7530-0	12-8020-1	17-7950-1





MODEL	SIZE					
机种	尺寸	NEEDLE PLATE 针板	FRONT FEED DOG 牙齿	REAR FEED DOG 牙齿	NEEDLE CLAMP 针头	PRESSER FOOT 压脚
V7002F	1/8 (232)	14-7260-0	15-7290-0	15-7580-0	12-8110-1	17-8260-1
	5/32 (240)	14-7360-0	15-7290-0	15-7580-0	12-8120-1	17-8360-1
	3/16 (248)	14-7460-0	15-7270-0	15-7560-0	12-8130-1	17-8460-1
	7/32 (256)	14-7560-0	15-7270-0	15-7560-0	12-8140-1	17-8560-1
	1/4 (264)	14-7660-0	15-7270-0	15-7560-0	12-8150-1	17-8660-1
V7003F	7/32 (356)	14-8560-0	15-7270-0	15-7560-0	12-8010-1	17-8860-1
	1/4 (364)	14-8660-0	15-7270-0	15-7560-0	12-8020-1	17-8960-1
V7002EMK	1/8	14-7280-0	15-7280-0	15-8280-0	12-8110-1	17-8290-1
	5/32	14-7380-0	15-7280-0	15-8280-0	12-8120-1	17-8390-1
	3/16	14-7480-0	15-7280-0	15-8280-0	12-8130-1	17-8490-1
	7/32	14-7580-0	15-7280-0	15-8280-0	12-8140-1	17-8590-1
	1/4	14-7680-0	15-7280-0	15-8280-0	12-8150-1	17-8690-1
V7003EMK	7/32 (356)	14-8580-0	15-7280-0	15-8280-0	12-8010-1	17-8890-1
	1/4 (364)	14-8680-0	15-7280-0	15-8280-0	12-8020-1	17-8990-1
W8002C	3/16 (248)	14-8030-0	15-7310-0	14-7610-0	12-8130-1	17-8470-1
	7/32 (256)	14-8040-0	15-7310-0	14-7610-0	12-8140-1	17-8570-1
	1/4 (264)	14-8050-0	15-7310-0	14-7610-0	12-8150-1	17-8670-1
W8003C	7/32 (356)	14-8010-0	15-7310-0	14-7610-0	12-8010-1	17-8870-1
	1/4 (364)	14-8020-0	15-7310-0	14-7610-0	12-8020-1	17-8970-1
W8002D	1/8	14-7240-0	15-7240-0	15-7550-0	12-8110-1	17-8240-1
	5/32	14-7340-0	15-7240-0	15-7550-0	12-8120-1	17-8340-1
	3/16	14-7440-0	15-7230-0	15-7530-0	12-8130-1	17-8440-1
	7/32	14-7540-0	15-7230-0	15-7530-0	12-8140-1	17-8540-1
	1/4	14-7640-0	15-7230-0	15-7530-0	12-8150-1	17-8640-1
W8003D	7/32 (356)	14-8540-0	15-7230-0	15-7530-0	12-8010-1	17-8840-1
	1/4 (364)	14-8640-0	15-7230-0	15-7530-0	12-8020-1	17-8940-1
W8002DE	1/8	14-7250-0	15-7240-0	15-7550-0	12-8110-1	17-8250-1
	5/32	14-7350-0	15-7240-0	15-7550-0	12-8120-1	17-8350-1
	3/16	14-7450-0	15-7230-0	15-7530-0	12-8130-1	17-8450-1
	7/32	14-7550-0	15-7230-0	15-7530-0	12-8140-1	17-8550-1
	1/4	14-7650-0	15-7230-0	15-7530-0	12-8150-1	17-8650-1
W8003DE	7/32 (356)	14-8550-0	15-7230-0	15-7530-0	12-8010-1	17-8850-1
	1/4 (364)	14-8650-0	15-7230-0	15-7530-0	12-8020-1	17-8950-1

MODEL	SIZE							
机种	尺寸	NEEDLE PLATE 针板	FRONT FEED DOG 牙齿	REAR FEED DOG 牙齿	NEEDLE CLAMP 针头	PRESSER FOOT 压脚		
WX8702D	1/8	14-8060-0	15-8050-0	15-8060-0	12-8260-0	17-6760-1		
	5/32	14-8070-0	15-8050-0	15-8060-0	12-8270-0	17-6770-1		
	3/16	17-8080-0	15-8050-0	15-8060-0	12-8280-0	17-6780-1		
	7/32	14-8160-0	15-8070-0	15-8080-0	12-8290-0	17-6790-1		
	21/42	14-8100-0	15-8070-0	15-8080-0	12-8300-0	17-6800-1		
WX8703D	7/32 (356)	14-8200-0	15-8070-0	15-8080-0	12-8380-0	17-6810-1		
	1/4 (364)	14-8190-0	15-8070-0	15-8080-0	12-8390-0	17-6820-1		
WX8802D	1/8	14-8060-0	15-8050-0	15-8060-0	12-8260-0	17-8060-1		
	5/32	14-8070-0	15-8050-0	15-8060-0	12-8270-0	17-8070-1		
	3/16	14-8080-0	15-8050-0	15-8060-0	12-8280-0	17-8080-1		
	7/32	14-8160-0	15-8070-0	15-8080-0	12-8290-0	17-8090-1		
	1/4	14-8100-0	15-8070-0	15-8080-0	12-8300-0	17-8100-1		
WX8803D	7/32 (356)	14-8200-0	15-8070-0	15-8080-0	12-8380-0	17-8180-1		
	1/4 (364)	14-8190-0	15-8070-0	15-8080-0	12-8390-0	17-8190-1		
WX8703DE	7/32 (356)	14-8220-0 14-8230-0	15-8070-0	15-8080-0	12-8380-0 12-8230-0	17-7850-1		
	1/4 (364)		15-8070-0	15-8080-0		17-7950-1		
WX8703DE	7/32 (356)		15-8070-0	15-8080-0		17-8850-1		
	1/4 (364)		15-8070-0	15-8080-0		17-8950-1		
WX8803C	7/32 (356)		14-8600-0	15-8230-0		15-8080-0	12-8380-0	17-8610-1
	1/4 (364)		14-8620-0	15-8230-0		15-8080-0	12-8390-0	17-8620-1
WX8802F	1/8 (232)	14-7260-0	15-8130-0	15-8140-0	12-8260-0	17-8260-1		
	5/32 (240)	14-7360-0	15-8130-0	15-8140-0	12-8270-0	17-8360-1		
	3/16 (248)	14-7460-0	15-8110-0	15-8120-0	12-8280-0	17-8460-1		
	7/32 (256)	14-7560-0	15-8110-0	15-8120-0	12-8290-0	17-8560-1		
	1/4 (264)	14-7660-0	15-8110-0	15-8120-0	12-8300-0	17-8660-1		
WX8803F	7/32 (356)	14-8560-0	15-8110-0	15-8120-0	12-8380-0	17-8860-1		
	1/4 (364)	14-8660-0	15-8110-0	15-8120-0	12-8390-0	17-8960-1		
DPW-1301S	花边车针位	14-302	15-302	15-362	12-702	17-301		
DPW-1301W		14-302	15-302	15-362	12-702	17-302		
DPW1302S		14-301	15-301	15-361	12-702	17-301		
DPW1302W		14-301	15-301	15-361	12-702	17-361		

MODEL	SIZE					
机种	尺寸	NEEDLE PLATE 针板	DIFF FEED DOG 牙齿	MAIN FEED DOG 牙齿	MAIN FEED DOG 牙齿	PRESSER FOOT 压脚
DW100-MD	356	90166	90625	90624	90624	90722
DW100-ME	364	90167	90632	90634	90634	90731
DV103-MB	240	91676	91728	91729	91729	94216
DW103-MD	356	91764	91728	91729	91729	94908
DW103-ME	364	91765	91728	91729	91729	94909
DW109-MD	356	92152	92146	92145	92145	92158
DW109-ME	364	92153	92146	92145	92145	92159
DW300-MD	356	90553	90625	90624	90624	90722
DW300-ME	364	90554	90632	90634	90634	90731
DW303-MD	356	90556	91728	90232	90232	94908
DW303-ME	364	90557	91760	90233	90233	94909
DW209-MD	240	95261	90276	92145	92145	95314
DW209-MC	248	95262	90276	92145	92145	95315
DW309-MD	356	95278	90276	92145	92145	95316
DW309-ME	364	95279	90276	92145	92145	95317
DV1250-MA	232	93170	93394	93395	93395	91131
DV1250-MB	240	93171	93394	93395	93395	91132
DV1250-MC	248	93172	93394	93395	93395	91133
DV1250-MD	256	93173	93394	93395	93395	91134
DV1250-ME	264	93174	93396	93397	93397	91135
DW1350-MC	348	94800	93394	93395	93395	90732
DW1350-MD	356	94801	93394	93395	93395	90722
DW1350-ME	364	94802	93396	93397	93397	90731
DV1253-MA	232	94210	94230	94231	94231	94215
DV1253-MB	240	94211	94230	94231	94231	94216
DV1253-MC	248	94212	94230	94231	94231	94217
DV1253-MD	256	94213	94230	94231	94231	94218
DW1253-ME	264	94214	94232	94233	94233	94219
DV1253 (N) -MA	232	94281	94260	94261	94261	94215
DV1253 (N) -MB	240	94282	94260	94261	94261	94216
DV1253 (N) -MC	248	94283	94260	94261	94261	94217
DV1253 (N) -MD	256	94284	94260	94261	94261	94218

MODEL	SIZE					
机种	尺寸	NEEDLE PLATE 针板	DIFF FEED DOG 牙齿	MAIN FEED DOG 牙齿	NEEDLE CLAMP 针头	PRESSER FOOT 压脚
DV1253 (N) -ME	264	94285	94262	94263	93255	94219
DW1353-MD	356	94901	94230	94231	93257	94908
DW1353-ME	364	94902	94232	94233	93258	94909
DW1353 (N) -MD	356	94921	94260	94261	93257	94908
DW1353 (N) -ME	364	94922	94262	94263	93258	94909
DV1259-MB	240	95261	95263	94593	93252	95314
DV1259-MC	248	95262	95263	94593	93253	95315
DW1359-MD	356	92152	94592	94593	93257	92158
DW1359-ME	364	92153	94592	94593	93258	92159
DW1359 (N) -MD	356	95278	95263	94593	93257	95316
DW1359 (N) -ME	364	95279	95263	94593	93258	95317
DV1400-MA	232	93170	93394	93395	93351	95580
DV1400-MB	240	93171	93394	93395	93352	95581
DV1400-MC	248	93172	93394	93395	93353	95582
DV1400-MD	256	93173	93394	93395	93354	95583
DV1400-ME	264	93174	93396	93397	93355	95584
DW1500-MC	348	94800	93394	93395	93356	95586
DW1500-MD	356	94801	93394	93395	93357	95587
DW1500-ME	364	94802	93396	93397	93358	95588
DW1500-C	356	94801C	9334ECM	93395	93357	64041-N
DW1500-E	356	94801ECM	9334ECM	93395	93357	90722ECM
DV1403-MA	232	94281	94260	94261	93351	94215
DV1403-MB	240	94282	94260	94261	93352	94216
DV1403-MC	248	94283	94260	94261	93353	94217
DV1403-MD	256	94284	94260	94261	93354	94218
DV1403-ME	264	94285	94262	94263	93355	94219
DV1403-MB-11	240	95234	95087	94233	93352	95238
DW1503-MD	356	94921	94260	94261	93357	94908
DW1503-ME	364	94922	94262	94263	93358	94909
DW1503-MD-11	356	95085	95087	94233	93357	95089
DV1409-MB	240	95261	95263	94593	93352	95314
DV1409-MC	248	95262	95263	94593	93353	95315

MODEL	SIZE					
机种	尺寸	NEEDLE PLATE 针板	DIFF FEED DOG 牙齿	MAIN FEED DOG 牙齿	NEEDLE CLAMP 针头	PRESSER FOOT 压脚
DW1509-MD	356	95278	95263	94593	93357	95316
DW1509-ME	364	95279	95263	94593	93358	95317
DV1600-MA	232	93170	93142	63350	63255	63318
DV1600-MB	240	93171	93142	63350	63256	63319
DV1600-MC	248	93172	93142	63350	63257	63320
DV1600-MD	256	93173	93142	63350	63258	63321
DV1600-ME	264	93174	63304	63351	63259	63322
DW1700-MD	356	94801	63142	63350	64010	64041
DW1700-ME	364	94802	93304	63351	61011	64042
VF2400-132M	232	0093170	3209001	3209000	3209100	0095580
VF2400-140M	240	0093171	3209001	3209000	3209101	0095581
VF2400-148M	248	0093172	3209001	3209000	3209102	0095582
VF2400-156M	256	0093173	3209001	3209000	3209103	0095583
VF2400-164M	264	0093174	3209003	3209002	3209104	0095584
VF2500-148M	348	0094800	3209001	3209000	3209106	0095586
VF2500-156M	356	0094801	3209001	3209000	3209107	0095587
VF2500-164M	364	0094802	3209003	3209002	3209108	0095588
VF2500-C	356	94801B	3209001C	3209000	3209107	64041-N
VF2403-132M	232	0094281	3209005	3209004	3209100	0094215
VF2403-140M	240	0094282	3209005	3209004	3209101	0094216
VF2403-148M	248	0094283	3209005	3209004	3209102	0094217
VF2403-156M	256	0094284	3209005	3209004	3209103	0094218
VF2403-164M	264	0094285	3209007	3209006	3209104	0094219
VF2403-140M-11	240	0095234	3209009	3209008	3209101	0095238
VF2503-156M	356	0094921	3209005	3209004	3209107	0094908
VF2503-164M	364	0094922	3209007	3209006	3209108	0094909
VF2503-156M-11	356	0095085	3209009	3209008	3209107	0095089
VF2409-140M	240	0095261	3209013	3209012	3209101	0095314
VF2409-148M	248	0095262	3209013	3209012	3209102	0095315
VF2509-156M	356	0095278	3209013	3209012	3209107	0095316
VF2509-164M	364	0095279	3209013	3209012	3209108	0095317
VC2600-132M	232	0093170	3109000	3109001	0093351	0063318

MODEL	SIZE					
机种	尺寸	NEEDLE PLATE 针板	DIFF FEED DOG 牙齿	MAIN FEED DOG 牙齿	NEEDLE CLAMP 针头	PRESSER FOOT 压脚
VC2600-140M	240	0093171	3109000	3109001	0093352	0063319
VC2600-148M	248	0093172	3109000	3109001	0093353	0063320
VC2600-156M	256	0093173	3109000	3109001	0093354	0063321
VC2600-164M	264	0093174	3109002	3109003	0093355	0063322
VC2700-148M	348	0094800	3109000	3109001	0093356	3107050
VC2700-156M	356	0094801	3109000	3109001	0093357	0064041
VC2700-164M	364	0094802	3109002	3109003	0093358	0064042
VC2700-C	356	94801B	3109030	3109001	0093357	64041-N
VC2603-132M	232	0094210	3109017	3109018	0093351	0094215
VC2603-140M	240	0094211	3109017	3109018	0093352	0094216
VC2603-148M	248	0094212	3109017	3109018	0093353	0094217
VC2603-156M	256	0094213	3109017	3109018	0093354	0094218
VC2603-164M	264	0094214	3109022	3109021	0093355	0094219
VC2603-140M-11	240	0095234	3109020	3109021	0093352	0095238
VC2703-156M	356	0094901	3109017	3109018	0093357	0094908
VC2703-164M	364	0094902	3109022	3109021	0093358	0094909
VC2703-156M-11	356	0095085	3109020	3109021	0093357	0095089
VG2700-148M	348	358002	3509004	3509005	0093356	3507050
VG2700-156M	356	358003	3509004	3509005	0093357	3507052
VG2700-164M	364	358004	3509004	3509005	0093358	3507054

### FOR TYPICAL 标准



GK10-3 008500044   GK31030 119500006   GK31030 119500007   GK321 197480010   GK321 197480011   GK321   GK32500 1105D0003



GK32700 182900001   GK331 190100010   GK331 190100011   GK331 190300008   GN2000 155100023   GN2000 155300024



GN2000 155300025   GN2000 155300026   GN2000 155300027   GN2000 155400025 #6   GN2000 155450002   GN2000 155730001



GN2000 159300001   GN2000 160400001 #2   GN2000-4G 155E00003   GN2000-4G 155E00005   GN2000-4G 155E00004   2000-4H 159K000011

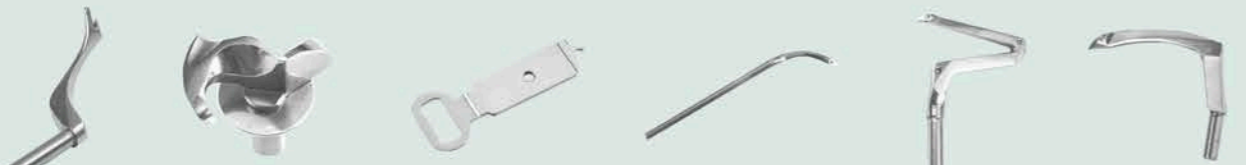

2000-3 210300001   GT660 BX07574009   GT660 BX74485009   30-3 052300011   30-3 052300023   GK0056-4 158C00014

### FOR TYPICAL 标准



GK0056-4 158C00013   GK0056-4 158C00005   GK0056-4 158C00006   GK0056-4 158C00008   GK0056-4 158C00009   GK0056-4 158C00010

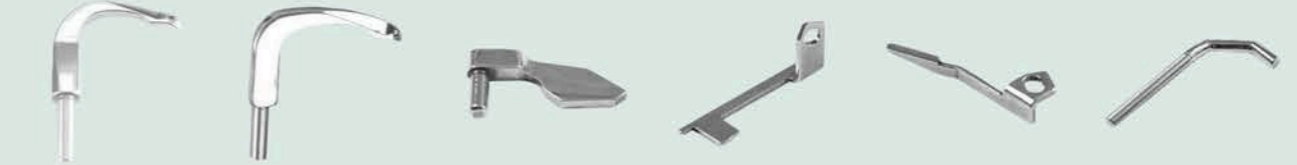

GT360 2044300001   GT360 2044400001   GK321-4W 197K30003   GK31030-6A 119500001   GK31030 116500006   GK32500 110500027

### FOR GOLDEN WHEEL 启翔



CS-1500 EP5584-0A-01   CS-1500 EP5337-0A   CS-1500-4 EP5337-1A   CS-1500-4 EP5337-460B   CSA-1500-460 EP5337-460C   CS-4500 LQ1238-0A   CS-4500 LQ1238-0B



CS-4500 LQ1239-0A   CS-4500 LQ1239-0B   CS-4500 LQ6100-0B   CSC-1400 LN6100-0A   CS-5930 EZ6111-0A(左)   CS-5930 EZ6112-0A(右)   CS-5930 EZ6113-0A



CS-1502-2-164M/L FG5585-1F(前)   CS-1402 LN6100-0B(A)   CS-1402 LN6100-1B(B)   CS-1402 LN5622-0B   CS-4550 LN6101-0A   CS-1502-2-164M/L FG5585-0F(后)   CS-4350 LR6100-0M

### FOR GOLDEN WHEEL 启翔



CS-4350 LR6100-OS   CS-4350 LR6100-OL   CS-1204 EH6100-3A   CS-1913 EH6100-OA-01   CS-1204 EH6101-OA   CS-1904 EV6015-OA   CS-1604 EH6100-OC



FA10084   CS-2614 ES6004-OA   CS-2614 ES6005-OA   CS-2516H-05 ES6006-OA   CS-2516 ES6007-OA   CS-2516H-05 ES6008-OA   CS-2600 ES6010-2A



CS-2614 ES6010-5A   CS-2614 ES6034-OA   CS-2516 ES6015-OA   CS-2515 ES6018-OA   ES6010-8A   ES6010-9A



ES6010-11A   ES6010-12A   CS-1603 KR6010-1A   CS-1603 KR6010-2A   CS-1603 KR6010-3A   CS-4650 FH6100-OA



CS-4650 268382   CS-4350 KF6010-OA-01   CS-1300 EP6100-OB   CS-1300 EP4255-OA   CSN-1300 EP4257-1A(后)   CSN-13001H EP6101-OH

### FOR GOLDEN WHEEL 启翔



CSA-3710 3710839300G   CS-4060 SL1321-OA   CS-MW MW-105-B   SK9 SK2071-OA   CST-2604PL KS1080-OA   CST-2604PL KS1081-OA

### FOR ZOJE 中捷



ZJ-W122 301.03-43   ZJ-W122 301.03-46   ZJ-W122 301.05-33   ZJ-W122 E356.10-28   ZJ-W122-356 E356.07-04   ZJ-W122-356 E356.07-03   ZJ-W122-356 E356.07-09



ZJ2500 K.03-36   ZJ2500 K.07-22   ZJ2500 K.08-34   ZJ2500 K.08-36   ZJ700 303.04-01   ZJ700 BI.4-2   ZJ700 B.4-20



ZJ700 B.4-37   ZJ700 B.4-39   ZJ700 B.4-42   ZJ700 B.4-44   ZJ700 B.4-46   ZJ700 B.4-55   ZJ700 BC.4-1



ZJ700 BC.4-2   ZJ700 BD.04-02   ZJ700 BH.4-11   ZJ700 BH.4-1   ZJ722-02X250 307.04-01   ZJ722-02X250 307.04-11   ZJ722-02X250 307.04-13

### FOR ZOJE 中捷



ZJ722-02X250 307.04-15    ZJ747.757 308.7-31    ZJ747.757 308.7-18    308.7-32    Z-91-102112-05    ZJ800 Z-91-102130-05    ZJ800 Z-91-102304-05



ZJ800 Z-91-102306-05    Z-91-102338-05    Z-91-102344-05    Z-91-102345-05    Z-91-102472-05    Z-91-102471-05    Z-91-102522-05



Z-91-136066-05    Z-91-136215-05    Z-91-136305-05    Z-91-136306-05    Z-91-136344-05    510.19-05-04    510.23.01-02



510.23.02-01    I.4-4    530.6-1    530.16-1    Z-94-175859-03    91-263294-05    91-263.310-05



95-669061-15    95-669093-05    0281-15-005    309.2.1    310.2-11    311.2.1    312.2.1

### FOR ZOJE 中捷

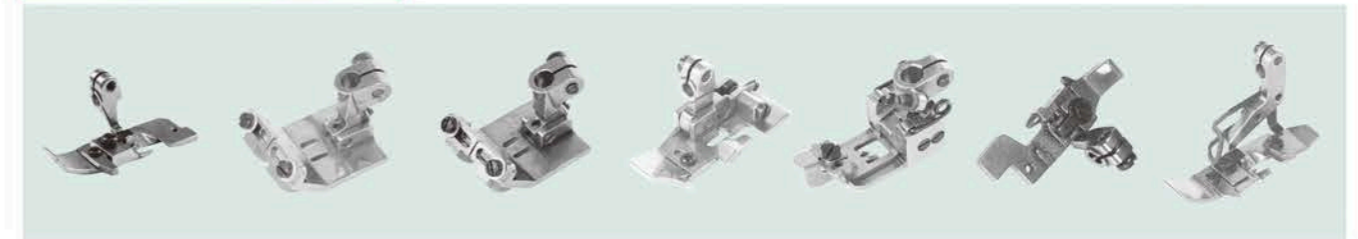

316.7.1    640.01-46-00    641.01-03-00    308.2.1    427.09.01-00    Z-91-105892-91    Z-91-102208-91

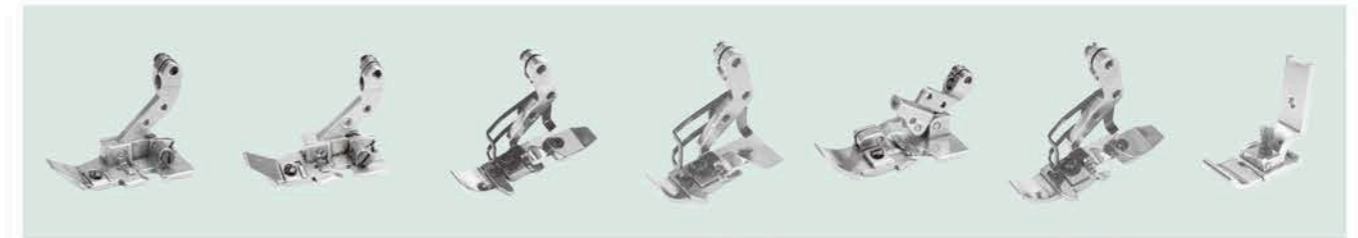

Z-91-102368-91    Z-91-102383-91    Z-91-102407-91    ZJ952-180 Z-91-102511-91    Z-91-102582-91    ZJ952-181 Z-91-102589-91    C2.3.1

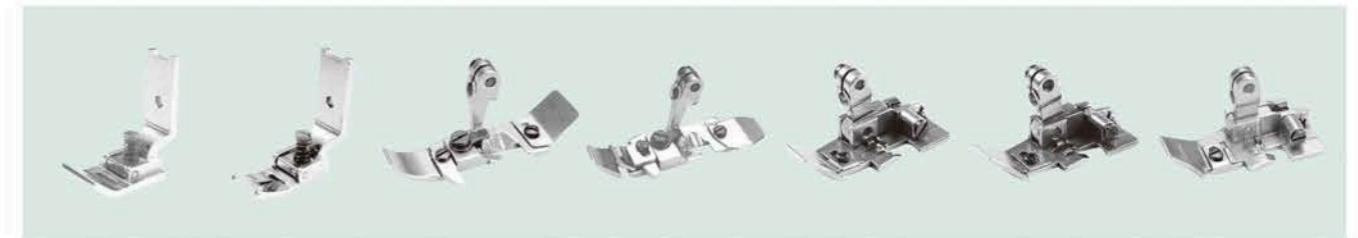

CD.3.1    C.3.1    BI.7-1    BH.7-2    369.07-01    B.7-8    BC.7-1



BD.07.01    Z-91-105884-05    Z-91-105886-91    309.8-2 309.8.1    308.8-50 308.8.2    E356.05-17 E356.05-18    Z-91-102469-05 Z-91-102477-91



Z-91-102508-05 Z-91-102098-91    Z-91-103077-91    Z-91-103078-05    Z-91-103035-05    Z-91-103036-05    Z-91-103053-05    Z-91-103055-05

### FOR ZOJE 中捷

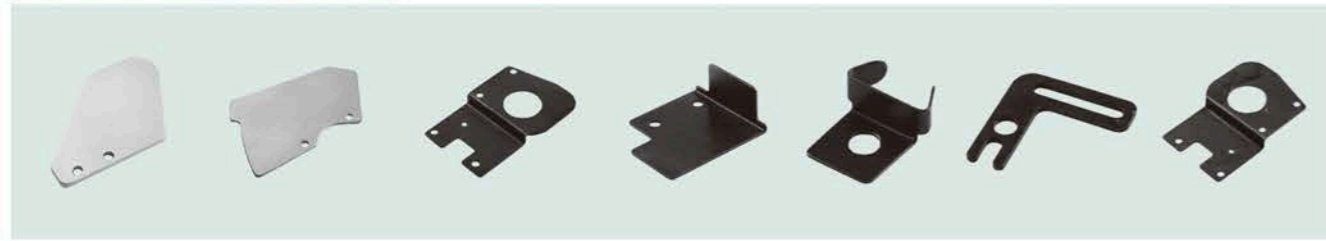

Z-91-149022-35   Z-91-149023-35   Z-91-149093-15(左)   Z-91-149094-15(左)   Z-91-149099-15   Z-91-149102-15   Z-91-149111-15



Z-91-149112-15(右)   Z-91-149116-15   Z-91-149119-15(左)   Z-91-149122-15(右)   Z-91-149125-15   Z-91-149149   Z-91-149177-15



Z-91-149179-15A   Z-91-149180-15B   Z-91-149184-15   Z-91-149224-15   Z-91-149230-15   Z-91-149232-15   Z-91-149237-15



Z-91-149293-15   Z-91-149303-15   B.1-11   Z-91-101322-15-2-5   761.5-3   511.23.01.05-01

### FOR JUKI 重机



116-81301   M03900 116-93108   MO-816 116-996   M02500 118-88101#81   M02500 118-88203#82   M02500 118-88302#83   118-88609

### FOR JUKI 重机



M02500 118-88401   M02500 118884   M02500 118-90308   M02500 118-90506   M02500 118-90605   MO-3900/6716 118-90902   MO-3900/6716 118-91009



MO-3900 119-91908#19   MO-3900/6714 119-96600#66   MO3900 119-99208#92   MO3900 119-99307   MO-3900 119-998   MO 119-95206   MO-3616/3916 120-154



MO-3900 121-76004   MO-3600 121-76202#62   MO-3600 121-76103#61   MO-3616 121-20705   MO3300 124-81107   MO3300 124-81008   MO3300 124-81800



MO3300 124-82600   MS1261 129-68509   MS1261 129-68806   MS1261 129-69101   MS-1190 129-40904   MS-1190 129-41803   MF-860 B2514-860



MH-38 B2008-038   MH-38 B2009-038   MH-380 B2030-380-000   MH-380 B2031-380-000   MS-26 B2513-026-F00   MS-26 B2514-026-000   MS-26 B2515-026-F00

### FOR JUKI 重机



<b>MS-19</b> B2513-019	<b>MS-19</b> B2514-019-B00	<b>M0357</b> B2011-357-000	<b>M0357</b> B2520-352	<b>MO357</b> B2521-352	<b>B2513-026</b>	<b>MO-816</b> B2521-804
---------------------------	-------------------------------	-------------------------------	---------------------------	---------------------------	------------------	----------------------------



<b>MB-372</b> B1239-372-000	<b>MB-373</b> B1239-373-000	<b>MB-373</b> B1237-373-000	<b>LK1900</b> B1812-980-0A0
--------------------------------	--------------------------------	--------------------------------	--------------------------------

### FOR PEGASUS 飞马



<b>R53-01</b> 202719	<b>RCD-601</b> 202861	<b>DCR53-01</b> 202408	<b>R53-01</b> 202874	<b>R53-01</b> 202703	<b>M700</b> 202828#4	<b>M600</b> <b>M700</b> 209009
-------------------------	--------------------------	---------------------------	-------------------------	-------------------------	-------------------------	--------------------------------------



<b>204072</b>	<b>M600</b> <b>M700</b> 204062#2	<b>M600</b> <b>M700</b> 204702#4	<b>204703#6</b>	<b>204963#8</b>	<b>M600</b> <b>M700</b> 204949#11	<b>M600</b> 204614A
---------------	--	--	-----------------	-----------------	---	------------------------



<b>M600</b> 204431	<b>M700</b> 209685	<b>M700</b> 204042	<b>M600</b> <b>M700</b> 204536	<b>M600</b> <b>M700</b> 204659	<b>M600</b> <b>M700</b> 209668	<b>M600</b> <b>M700</b> 209669
-----------------------	-----------------------	-----------------------	--------------------------------------	--------------------------------------	--------------------------------------	--------------------------------------

### FOR PEGASUS 飞马



<b>L32</b> 204781	<b>L32</b> 204782	<b>M600</b> <b>M700</b> 208356	<b>M700-W61</b> 208357	<b>M700-W61</b> 208358	<b>M622-02</b> 208360	<b>W500</b> 257550
----------------------	----------------------	--------------------------------------	---------------------------	---------------------------	--------------------------	-----------------------



<b>W500</b> 257551B	<b>W500</b> 257553	<b>W500</b> 257565	<b>W600</b> 257552	<b>W600</b> 257566	<b>W600</b> 257567	<b>W600</b> 257568
------------------------	-----------------------	-----------------------	-----------------------	-----------------------	-----------------------	-----------------------



<b>E52</b> 210356	<b>E56</b> 210354	<b>E56</b> 210359	<b>W52</b> 210365#24	<b>E52</b> 210364#22	<b>E52</b> 210724	<b>211168</b>
----------------------	----------------------	----------------------	-------------------------	-------------------------	----------------------	---------------



<b>E52</b> 213105	<b>213107</b>	<b>EX3200</b> <b>EX5200</b> 277004	<b>EX3200</b> 277005	<b>EX3200</b> 277006	<b>EX3200</b> 277007	<b>EX5214</b> 277008
----------------------	---------------	--	-------------------------	-------------------------	-------------------------	-------------------------



<b>EX5200</b> 277010#2	<b>EX5204-24</b> 277011#3	<b>EX5214</b> 277010A#5	<b>EX5214-01</b> 277010B6	<b>EX3215</b> 277014A#8	<b>EX5203</b> 277014B#9	<b>EX5214H</b> 277017#11
---------------------------	------------------------------	----------------------------	------------------------------	----------------------------	----------------------------	-----------------------------

### FOR PEGASUS 飞马



EX5214H-55 277019#12    EXT5104 277062#14    EXT5101 277063#15    EX5200 244011B#17    EXT5104 277001    EX3200 277015    EX3216H 277015A



EX3200 277015B    EX3200 277016A    EX5214 277034    EX5200 277060    EX3200 277018    EX3200-05 277018C    FS613 236500



FS613 236601    M700 208778    M700 209621    M700 209622    M700 209623    M700 209624    M700 209625



M700 209626    M700 209627    M700 209628    M700 209629    M700 209630    M700 209646    M700 209653



M700 209608    M700 209683    M700 209684    M700 275035    M700 275036    M700 275039    W500 253511

### FOR PEGASUS 飞马



W500 253516    W500 253548    M800 2040720    M852-17 2040620#2    M832-38 2047020#4    M832-86 2047030#6    M852-13 2049631#81



M852 13H 2F000300000#17    M800 2090090    M852-13 2046591    M832-38 2096850    M832-86 209685ACO

### FOR YAMATO 大和



306 37271    306 37272    2300 Y94480    8000 2109331    AZ6100 21750    AZ6125 2109347    AZ6500 2109300



AZ6500 2109320    AZ8000 2109310    AZ8500 2109302    CM251 80413    DCY-109 37076    DCY-109 37832    DCZ-200 Y32807



DCZ-341 35254    DCZ-341 Y35253    DCZ-400 Y34113    34584    DV200 Y90529    DZZ-290 34393    DZZ-292 21700

FOR YAMATO 大和



DZZ-292 34392    FD-62 68123(1)    FD-62 68123(2)    FD-62 Y68124    FD-62 Y68217    Z5000 21701    Z6100 21756



Z6100 21757    Z6100 33610    2109343    2119301    6209301    6209300    DV1250 3209311



VC2700 3109200    VC2700 3109201    VC2700 3109300    VC2700 3109310    VT1500 6509200    VT1500 6509200    VT1500 6509201



VT1500 6509300    VT1500 左导骨    VT1500 右导骨    左导骨片    右导骨片    350142

FOR SIRUBA 银箭



737 LP21    747.757 LP22    737 LP23    747.757 LP24    747.757 LP26    757 LP26A    747.757 LP38

FOR SIRUBA 银箭



747.757 KL25    747.757 KL25A    757 KL35    757 KM04    747.757 KG31    747.757 KG35    747.757 KG37



747.757 Kg59    747.757 KG471    737K-504M LP225    747K-514M2 LP226    757K LP230    757K KL202A    757K KM203



VC008-4 VE51    VC008-13 VE51P    VC008 VSM47    VC008 VE30Q    VC008 VE49    C007 MH41    C007 MT01



F007 ME28    F007 ME29    F007 ME67    C007 MV06    C007 MV10    Z008 ZD21    Z008 ZD22

FOR BROTHER 兄弟



9280 S40375    9280 S40376    9280 S40377    B925 148869    B925 148870    B925 148872    140161-0-01

### FOR BROTHER 兄弟



B551 143734-0-01    B551 144049    SO1249    X70528-0-01    B551 146635    B551 147934    B551 147936-0-01



B271 S08934    S01248    B271 S08913    S124842-0-01    981 S35410-001    981 S35411-001    981 S35412-001

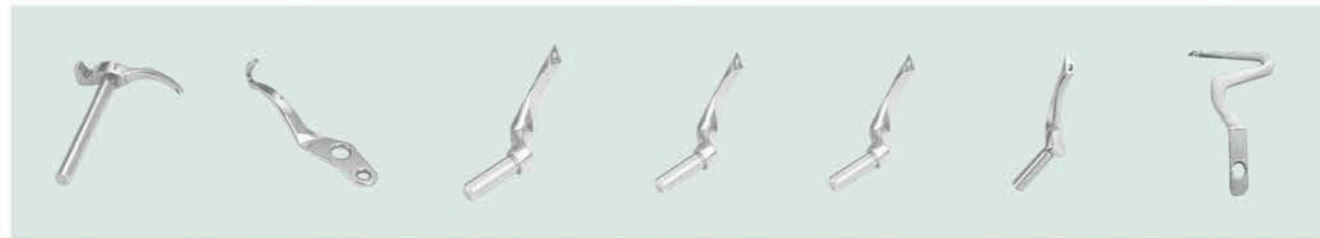

981 S35413-001    EF4-N11.N21 S20415-0-01    EF4-N21 S20422-001    EF4-N21-37 S20428-001    EF4-N31 S20424-001    MA4-N31-65 S20438-001    N31 S20626



N31 S20653    127814    127815    127260-01

### FOR KANSAI SPECIAL 森本



1404 19-112    1404 19-416    1404 19-431    1404 19-437    19-439    1502P 19-531    1503 19-546

### FOR KANSAI SPECIAL 森本



1503 19-547    1503 19-548    1508P 19-581    1508P 19-582    18103D 19-540    18103D 19-801    B2000 19-712



DFW-1302W 19-351    DPW-1302W 19-353    DVK1700 19-713

### FOR SINGER 胜家



32820    32821    32824    164375    164619    175085    410434    410452

### FOR UNION SPECIAL 于仁



21000 2108    35800 35808AY    35800    35800 35809BY    36200 36208A    36200 36251F    39500 39508A



39500 39508D    51100 51108DA    51900 51908D-9    81200 50309K



202094    202095    204022    204314    627/629 209248    627 209264    304186-0-13



211240    21167    305668-0-00    351161    307381002    209248    211261

FOR REECE 利是



104/101 D4    104/101 D5    104 101 D6    104 101 D7    104 D8    104 D9    180 S116-N    180 S119-N

FOR SHING LING 星菱



FW777 FD11    FW777 FE22

FOR OTHER 其他系列



4-2    36-19    36-21    111    GE2108    GP161    S001 前弯针 Front looper



S002 后弯针 Back looper    25523    25523L

FOR 380 机型

单针针位组  
Single needle



S003 护针 Needle guard    S004 护针 Needle guard    S005 针板 Needle plate    S006 压脚 Press foot    S007 牙齿 Feed dog

纵针针位组  
Vertical needle



S008 护针 Needle guard    S009 护针 Needle guard    S010 针板 Needle plate    S011 压脚 Press foot    S012 牙齿 Feed dog    S013 针夹 Needle clamp

品字型  
针位组  
Stagger



S014 护针 Needle guard    S015 护针 Needle guard    S016 护针 Needle guard    S017 针板 Needle plate    S018 压脚 Press foot    S019 牙齿 Feed dog    S020 针夹 Needle clamp

斜-字针位组  
Oblique



S021 护针 Needle guard    S022 护针 Needle guard    S023 针板 Needle plate    S024 压脚 Press foot    S025 牙齿 Feed dog    S026 针夹 Needle clamp

2200448



双风鼓转子  
Double drum rotor

S60-01R



单风鼓转子  
Single drum rotor

2200449



三风鼓转子  
Three drum rotor

M7C (MT180)



刀头组  
Knife group

F2C (FT100)



刀头组  
Knife group

4117



碳刷  
Carbon brush

F600/780/1000/1600



软轴  
Flexible axle

H800/H1400



软管  
Flexible pipe

360A-2



双方位气动脚踏开关组  
Swift

360A-3



三方位脚踏开关组  
Swift

F2C-25U



刀片组  
Knife group

M7C-25V



刀片组 (陶瓷)  
Knife group (ceramics)

F2-MSV



钢动刀片 (V)  
Steel blade

M7-MCV



陶瓷动刀片 (V)  
Ceramics blade

F2-MCU



陶瓷动刀片 (U)  
Ceramics blade

S60-04



集尘桶  
Collect box

C80-01M



剪线马达  
Clipper motor

S60-01M



吸风马达  
Suction motor

S60-01M2



双风鼓吸风马达  
Suction motor

FOR KANSAI 森本 1508 / 1404 / 1702

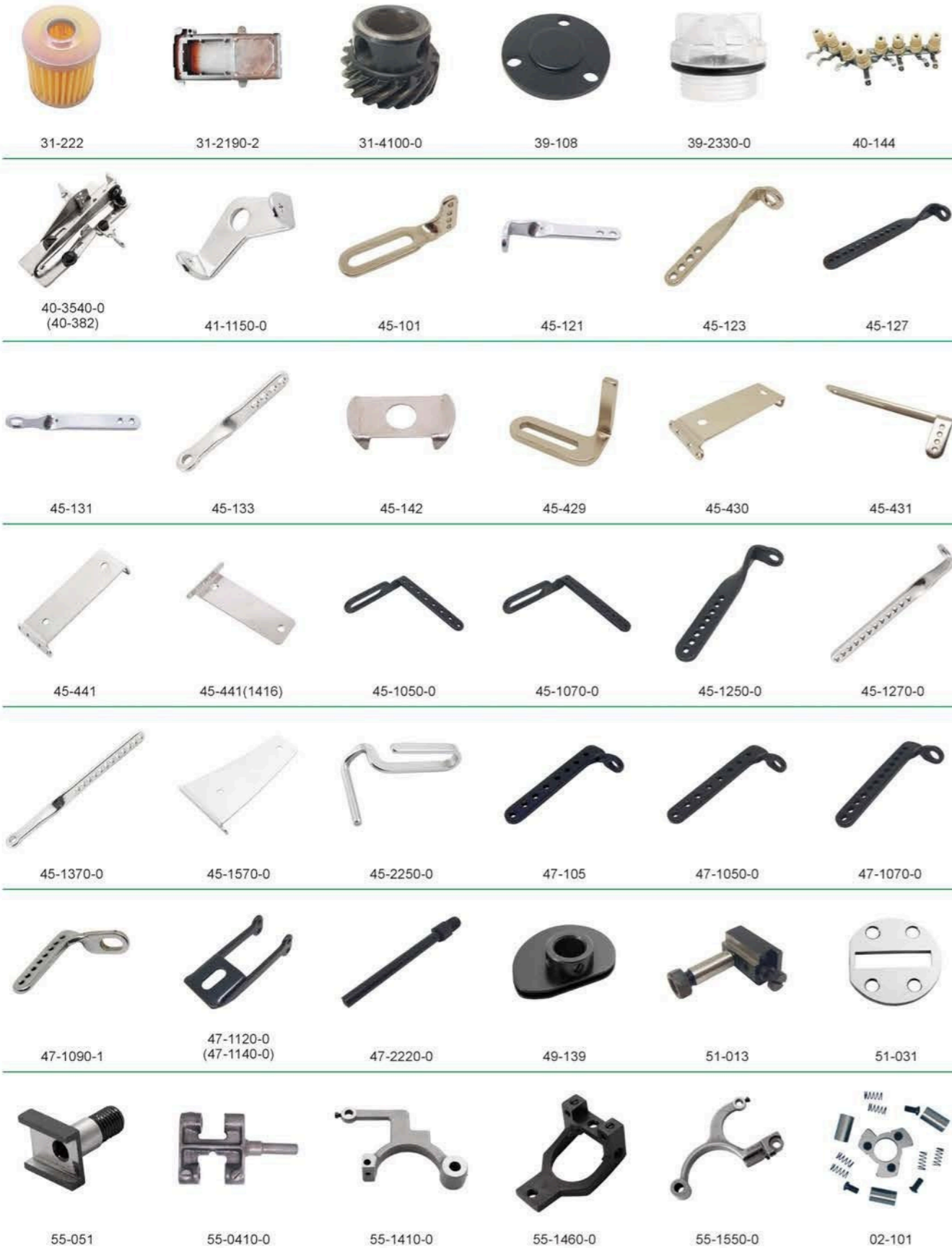

U4 / 1702



# TOPDIS

04 / 1702

# TOPDIS

04 / 1702



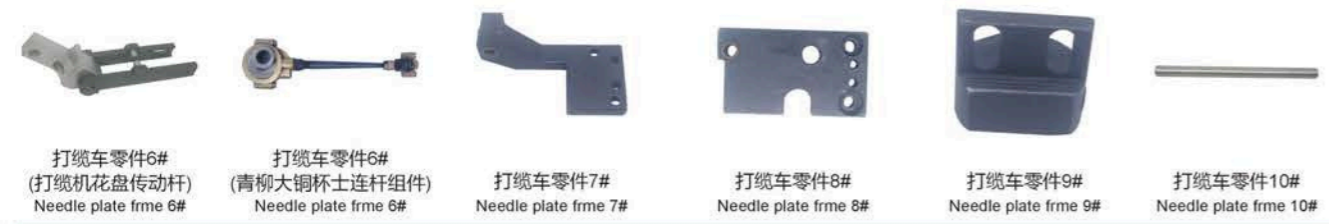

花样盘 Pattern plate  
101  
201  
202  
222  
211L  
214L  
231



花样盘 Pattern plate  
302  
302L  
371  
381L  
381R  
392L  
471L



花样盘 Pattern plate  
482L  
545L  
571  
592L  
602L  
671L  
674L



# TOPDIS

# TOPDIS

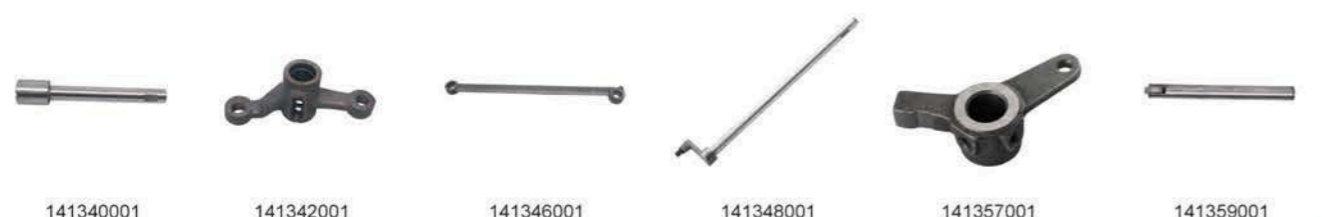
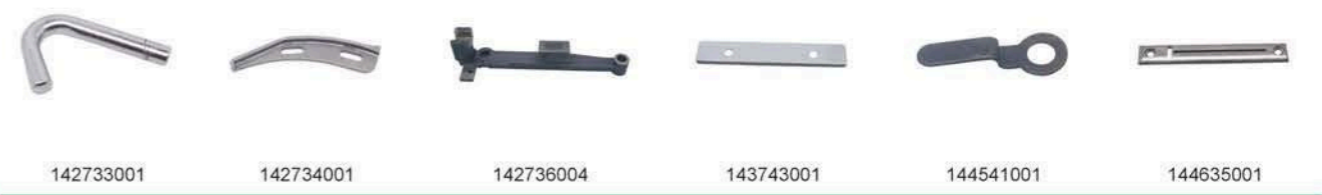

# TOPDIS

# TOPDIS



FOR PEGASUS 飞马 EX3200 / 5200



270505    270512A    271007    271505-92    271513-91    273006



DSC06230    DSC06246    DSC06273    PEGASUS Ex3200 ( 273006 )    PEGASUS EX3200零件 Sewing part

FOR PEGASUS 飞马 L32 / L52 / M600



204096    204638    204755    208346    210530    DSC06245



PEGASUS L32  
( 205468-UA 204469-UA )

FOR PEGASUS 飞马 M700



208905    208909    209612-D    209670    209681    PEGASUS M700 L32 ( 205466 )

FOR PEGASUS 飞马 W664



253500    253589-91    253598    253599    256517    256519



256545    256547    257567    257568    DSC06224    PEGASUS W664 ( 252040 )



PEGASUS W664 ( 252045 )

FOR PEGASUS 飞马 W500



W500 253509A    562-01D    252009-92    253548    256012    W500 ( 257553 )



W500 ( 252007-92 )    204097A    206059A    206157    208549    209674



210091    234521    240115    250021    250051    251003-91

FOR PEGASUS 飞马 W500



251505 252001-92 252009-92 252053 252500-91 252502-92



252519 252521 252522 252523 252526 253028



253504 253505B 253506 253507 253508 253509 253511



253514 253515 253533 253534 253544 253605



253614 253615 253680 254511-92 254516-92 257577 257578

FOR JUKI 重机 372 / 373



(372) B2019-372-0A0 (373) B1220-372-0A0 (373) B1221-372-0A0 (373) B1224-372-0A0 B2546-372-000 JUKI 373 (B1239-372-000)

FOR JUKI 重机 1850



(JUKI 1850) B3219-232-000 1850 135-03107 1850 135-10607 1850 B1814-980-000 1850 B1815-980-000 1850拉筒架子



1850小针板 (2.0 2.5 3.0) B1817-280-0A0 B1818-280-000 JUKI 1850 B3258-781-0A0

FOR JUKI 重机 3168



JUKI 3168 (226-05208) JUKI 3168 (226-13509) JUKI 3168 (226-81407) JUKI 3168 (226-83502)

FOR JUKI 重机 781 / 783



(JUKI781) B3110-771-0A0 (JUKI 783V) 139-50902 (JUKI 783V) 139-53054 (JUKI 783V) 139-53500 (JUKI 783V) 139-54508 (JUKI 783V) 139-54656



(JUKI 783V) 139-55901 (JUKI 783V) B2016-357-A00 139-53500 139-53609 139-54656 139-55406



139-55901 D9332-762-T00    B2615-761-000    B3107-362-000    B3119-352-000 NS-6150310-SP    B9314-762-T00    D2615-762-V00



D2902-762-V00    D2904-762-V00    D2951-782-V00    D9301-762-V00    DSC05551    DSC05554



DSC05557    DSC05559    DSC05561    DSC05565    DSC05567    DSC05577



DSC05579    DSC05581    DSC05582    JUKI 783 136-26308    JUKI 783 139-25805    JUKI 783 139-25904



JUKI 783 139-51108    JUKI 783 139-51306    JUKI 783 139-54300    JUKI 783 139-55505    JUKI 783 139-55802    JUKI 783 139-56008



JUKI 783 139-56107    JUKI 783 B1504-280-000    JUKI 783 D3106-772-B00    JUKI 783 D3130-772-B00    JUKI 783 D4122-804-000    JUKI 783 D9302-762 T00



JUKI 783 D9315-762 T00    JUKI 783V 137-54052    JUKI 783V 139-53609    JUKI 783V 139-55406

FOR JUKI 重机 1903



( JUKI1900A ) 400-31136    ( JUKI1903 ) 141-03154    ( JUKI1903 ) 141-46906    (JUKI 1190) B2109-019-0A0    (JUKI 5550) 110-52701    ( JUKI 1903 ) MAZ-155-6000



JUKI1903零件/Part    JUKI1903配件/Part    JUKI 1900A 挑线杆组件 Take-up-lever    JUKI 1900牛角    JUKI 1903    JUKI ( MS-1190 ) 129-35011



JUKI(MS-1190)B1610-019-000 B1608-019-000-A    JUKI(MS-1190) B2107-019-000    JUKI(MS-1190) B2116-191-00A    JUKI(MS-1190) B2116-191-00B    JUKI(MS-1190) B2502-019-000    JUKI(MS-1190) B2106-019

FOR JUKI 重机 3200



(JUKI 3200) 140-29755    (JUKI 3200) 140-30001    (JUKI 3200) 140-30506    (JUKI 3200) 140-31207    (JUKI 3200) 140-31306    (JUKI 3200) 140-32403



(JUKI 3200) 320-20505    (JUKI 3200) 320-20703    (JUKI 3200) 320-38606    (JUKI 3200) 320-38705    (JUKI 320) 320-43416    ( JUKI 3200 ) 320-69604



(JUKI 3200) 320-20604    JUKI 3200 320-35008    JUKI 3200 320-35107

FOR JUKI 重机 3616



FOR SIRUBA 银箭 747



FOR SIRUBA 银箭 C007 / F007



FOR SIRUBA 银箭 VC008





VF13 VF16 VJ21 VK13(VC008) VK15P VK17P



VK18P 银箭三星 SIRUBA

FOR SINGER 胜家 457



225-07156 373-75 457G-188 457-T1 457-T2 210505



411007 411015-451 411016-451 411035 411146(502969) 411360(551901)



411394(551893) 502509 502545 502546 502587-002 502704 502720



502768 502843 502844 502996 508585 508880

FOR SINGER 胜家 457



528613 Gb107 KH457-T1 KH457-T2

FOR REECE 利是 101



01-2033 01-2039 01-2130 01-2193 01-2390 01-3007 10-1301



01-3008 01-3025 10-1061-1 01-7022 01-7023 01-7761-412 01-8002



10-1016-2 10-1025-1 10-1028-2 10-1028-2 10-1032 10-1036-1



10-1049 10-1097-1 10-1120 10-1128 10-1163 10-1194



10-2006-2 10-2020 10-2044-0-023 10-2048-0-022 10-2046-1-751 10-2050-1-751 10-2052 10-2051-2 01-3001 10-2060-1-450 10-2059-1-450

FOR REECE 利是 101



10-2061      10-3005      10-3007      10-3020      10-3035-1      10-3079



10-4002      10-6132      14-4011-0-200      14-4201      梅花螺丝 Screw

FOR UNION SPECIAL 于仁 35800



35751      35751B      35751F      35760D      35760E      35761



35761D(黑)      35761D(黄 Yellow)      35763F      35764D      35766A      35766B



35772R(T)      35772S      35780E      35792S      35800      35800



35800旧款针位 Old needle gauge      35800      35800      35800新款针位5-16 New type needle gauge      35800      35800

FOR UNION SPECIAL 于仁 35800



35800      35800      35815A      35817E      35826M黑平 Black      35826M黄平 Yellow



35826M胶齿 Rubber      35826M铁 Iron      35830K      35833C      35833D      35833E



35834AE      35834R      35834U      35835A      35836      35841B



35842H      35843B      35844      35844D      35845D      35846



35847E      35848B 35848D 35848E      35849C      35850B      35850C      35850D



35851G      35851S 35851P 22560A      35853AL      35853Z 35853Y 35853AA 35853W      35856AA      35856Y



35859C      35859D      35862      35870      35871A 35871B      35873AD





35721H 35722AE轴 Shaft 35723C 35731F 35733F 35746A

FOR UNION SPECIAL 于仁 63900

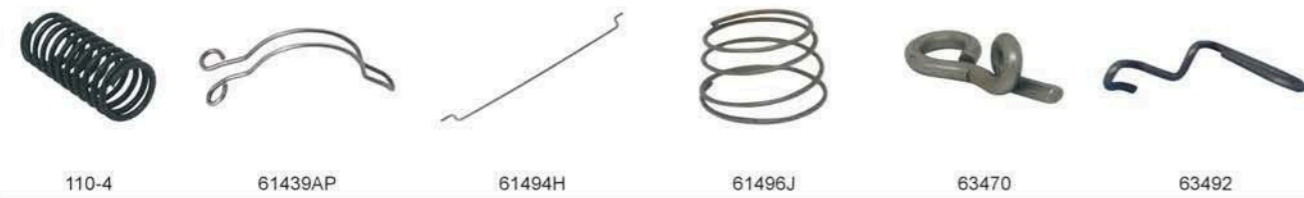

110-4 61439AP 61494H 61496J 63470 63492



63493G 63900压脚 Fress foot (1/4~1-1/8) 63928 63939F 63970-A 63993H

FOR NEW LONG 封包机/BAG CLOSER NP-7 / CK26-1



(封包机/Bag closer NP-7) (封包机/Bag closer NP-7) (封包机/Bag closer NP-7) (封包机/Bag closer NP-7) (封包机/Bag closer NP-7) (封包机/Bag closer NP-7)  
241024 241092 241111 241122 241212 2450422



15-1 (B3425-555-000) 封包机/Bag closer NP-7 (C01028)

FOR SEIKO 精工 CW8B 35800



10546-A 13006 13032 13034 13041 13041C 13051



13395 13409 13415 19419

FOR OTHER 其他零件



Az8500 B1111-372-000 B1501-380-000 B1509-555-000 B1511-555-000 B2311-380-E00 B2342-205-0A0



B2402-771-000 B3514-412-000 BROTHER 917 DU车的 DU DY



DY三菱牙架 MITSUBISHI EX3200 (240326) EX3200 (270032A 202875 270034) GR151油泵 Oil pump KANSAI 69-803 KHF111



N31 S20625151 NS-6160520-SP S02563-001 S37671-101 S37672-101 S37675-101

### FOR OTHER 其他



### FOR OTHER 其他



NEEDLE PLATE 晒板



( BROTHER 430 ) 152792001



( BROTHER 430 ) S00908001



( BROTHER ) 153205201



( JUKI 373 ) B2529-372-000 ( 大孔 Big hole )



( JUKI 1850 ) 13517701



1006 PLATE 70X110MM



1010 PLATE 112X118MM



JUKI 210D PALATE 72X140MM



JUKI 210D PLATE 60X100MM



JUKI 210D PLATE 70X72MM



JUKI 1850 PLATE 23X6MM



JUKI 1900 PALTE 45X10MM

NEEDLE PLATE 晒板



JUKI 1900 PLATE 26X6MM



JUKI 1900 PLATE 28X6MM



JUKI 1900 PLATE 28X8MM



JUKI 1900 PLATE 39X7MM



JUKI 1900 PLATE 40X10MM



JUKI 1900 PLATE 40X13MM



JUKI 1900 PLATE 45X7MM



JUKI 1900 PLATE 52X7MM



JUKI 1900 不锈钢晒板 Stainless steel plate 28X6MM



JUKI 1900 晒板 Needle plate



JUKI 1900 晒板 Needle plate 12.5X12.5MM, 10X10MM, 8.5X8.5MM



JUKI 1900 晒板压脚框 Selenium presser foot

